

Transistors

2SC1393



TV VHF TUNER RF AMPLIFIER (FORWARD AGC)

- High Current Gain Bandwidth Product $f_T = 700\text{MHz}$ (Typ)
- Low Noise Figure $NF = 3.0\text{dB}$ (Max) at $f = 200\text{MHz}$
- Low Reverse Transfer Capacitance $C_{re} = 0.5\text{pF}$ (Max)

ABSOLUTE MAXIMUM RATINGS ($T_a = 25^\circ\text{C}$)

Characteristic	Symbol	Rating	Unit
Collector-Base Voltage	V_{CBO}	30	V
Collector-Emitter Voltage	V_{CEO}	30	V
Emitter-Base Voltage	V_{EBO}	4	V
Collector Current	I_C	20	mA
Collector Dissipation	P_C	250	mW
Junction Temperature	T_j	150	$^\circ\text{C}$
Storage Temperature	T_{stg}	-55 ~ 150	$^\circ\text{C}$

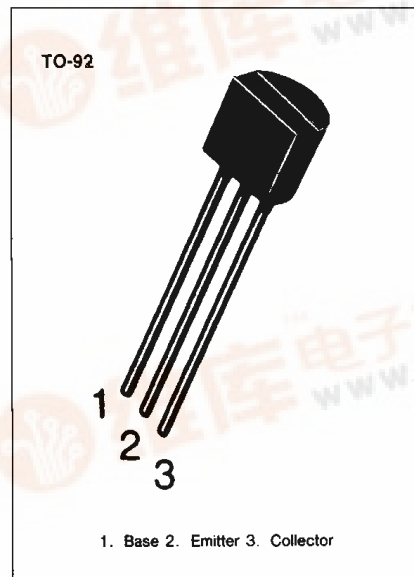

ELECTRICAL CHARACTERISTICS ($T_a = 25^\circ\text{C}$)

Characteristic	Symbol	Test Conditions	Min	Typ	Max	Unit
Collector-Base Breakdown Voltage	BV_{CBO}	$I_C = 10\mu\text{A}, I_E = 0$	30			V
Collector-Emitter Breakdown Voltage	BV_{CEO}	$I_C = 5\text{mA}, I_B = 0$	30			V
Emitter-Base Breakdown Voltage	BV_{EBO}	$I_E = 10\mu\text{A}, I_C = 0$	4			V
Collector Cut-off Current	I_{CBO}	$V_{CB} = 20\text{V}, I_E = 0$			0.1	μA
DC Current Gain	h_{FE}	$V_{CE} = 10\text{V}, I_C = 2\text{mA}$	40		180	
Current Gain-Bandwidth Product	f_T	$V_{CE} = 10\text{V}, I_C = 3\text{mA}$	400	700		MHz
Reverse Transfer Capacitance	C_{re}	$f = 1\text{MHz}, V_{CB} = 10\text{V}, I_E = 0$		0.35	0.5	pF
Power Gain	G_{pe}	$f = 200\text{MHz}, I_E = -3\text{mA}, R_S = 50\Omega, V_{CE} = 10\text{V}$	20	24		dB
AGC Current	I_{AGC}	I_E at $G_{pe} = -30\text{dB}, f = 200\text{MHz}$		-10	-12	mA
Noise Figure	NF	$f = 200\text{MHz}, I_E = -3\text{mA}, V_{CE} = 10\text{V}, R_S = 50\Omega$		2.0	3.0	dB

h_{FE} CLASSIFICATION

Classification	R	O	Y
h_{FE}	40-80	60-140	90-180



STATIC CHARACTERISTIC

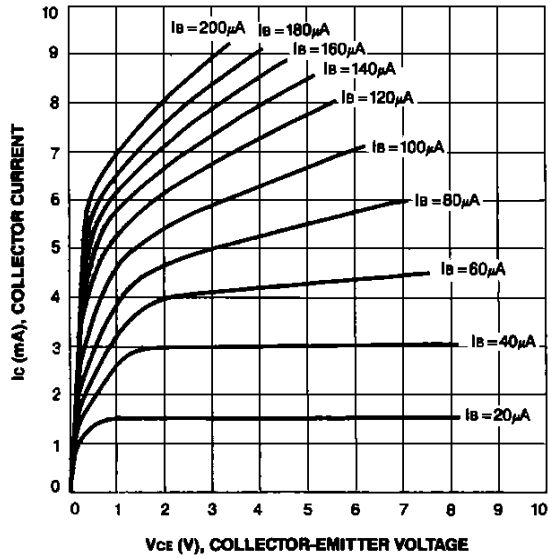

DC CURRENT GAIN

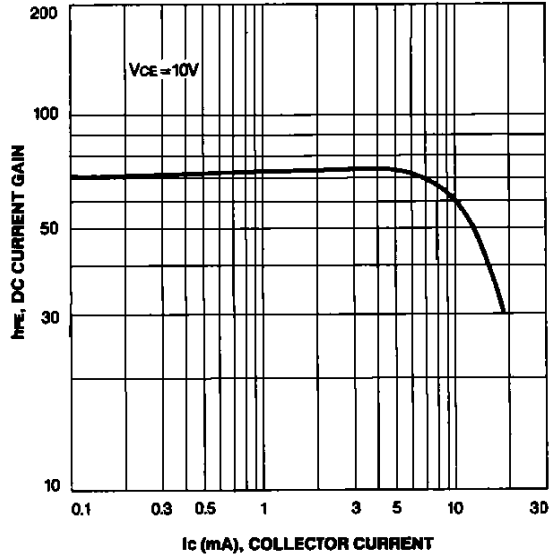

CURRENT GAIN-BANDWIDTH PRODUCT

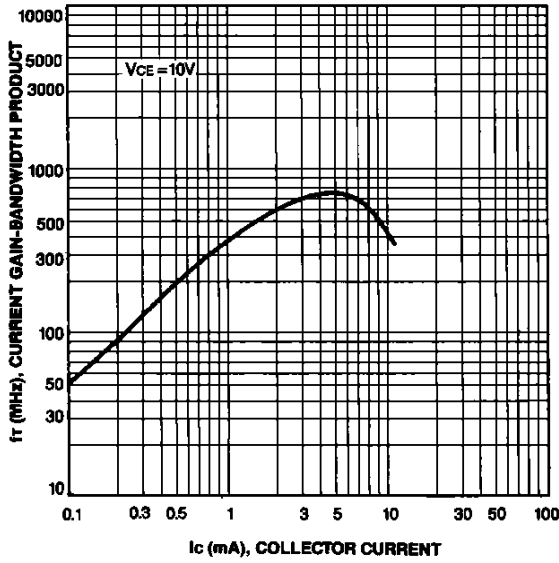

BASE-EMITTER SATURATION VOLTAGE COLLECTOR-EMITTER SATURATION VOLTAGE

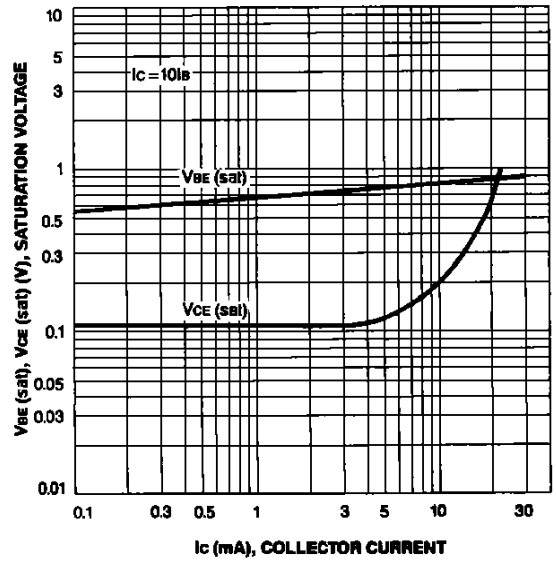

REVERSE CAPACITANCE

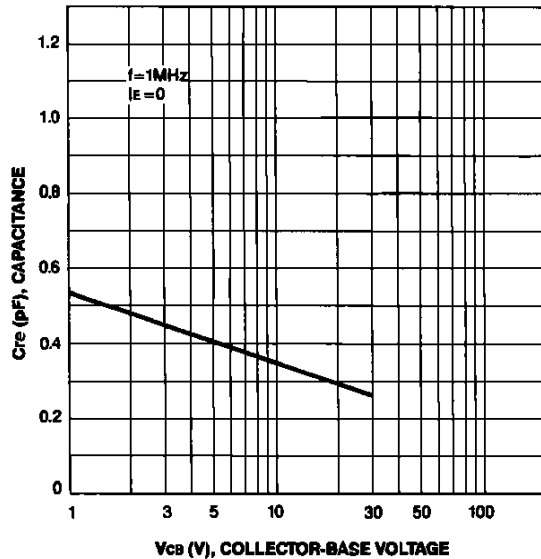

INPUT ADMITTANCE (y_{ie}) vs. FREQUENCY

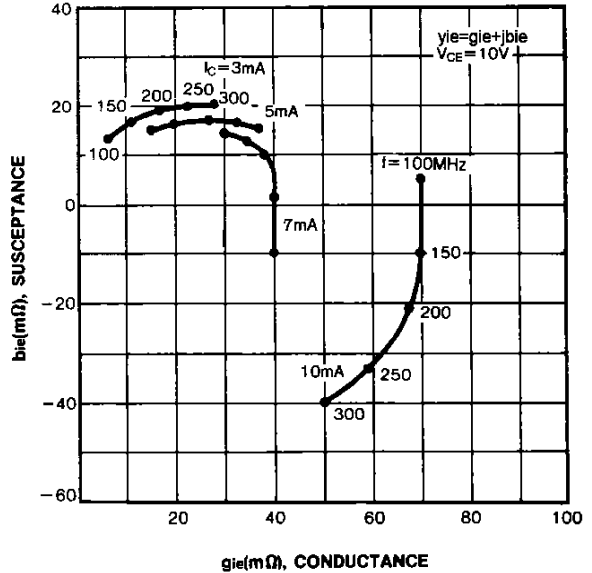

REVERSE TRANSFER ADMITTANCE (y_{re}) vs. FREQUENCY

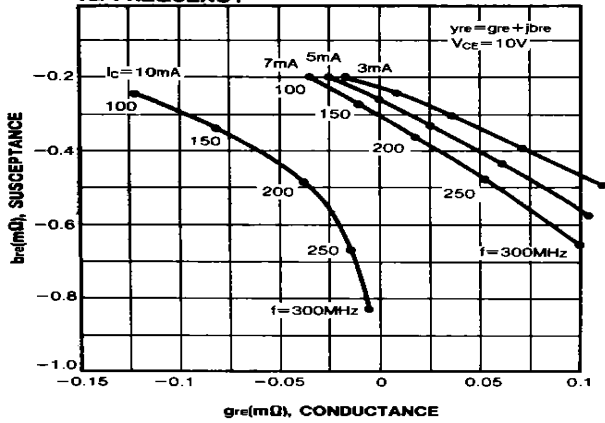

FORWARD TRANSFER ADMITTANCE (y_{fe}) vs. FREQUENCY

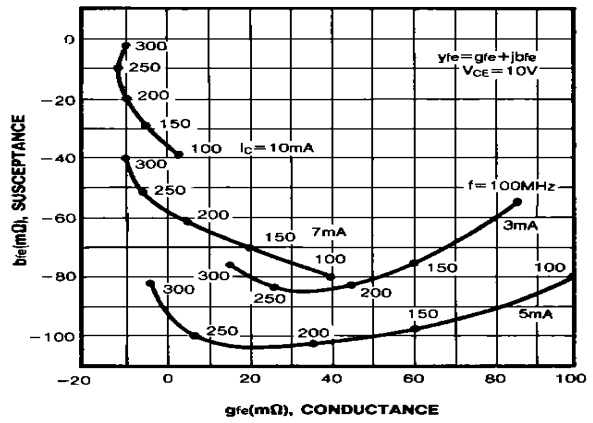

OUTPUT ADMITTANCE (y_{oe}) vs. FREQUENCY

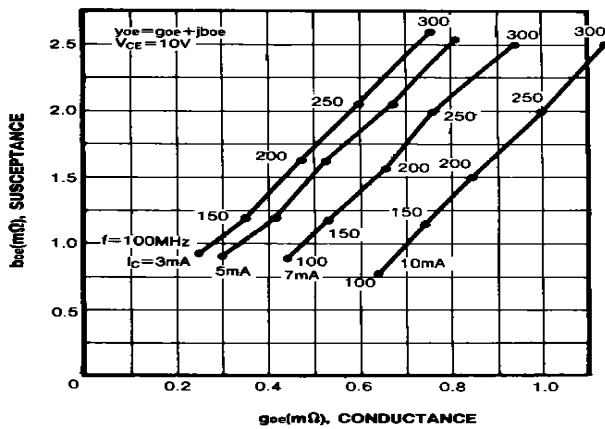

POWER GAIN AND NOISE FIGURE vs. COLLECTOR CURRENT

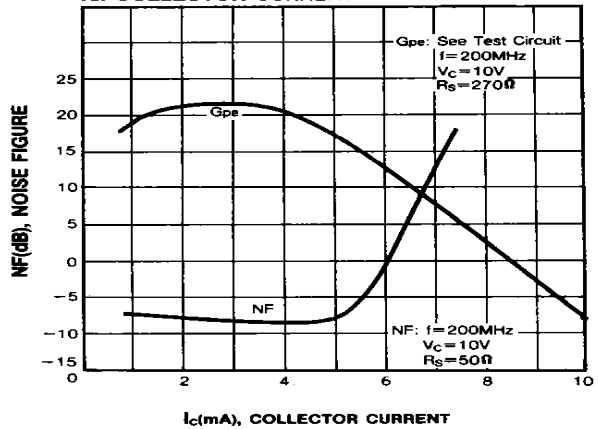

POWER GAIN AND NOISE FIGURE TEST CIRCUIT

