

2SC1570,  
1571,  
1571L



2003A

NPN Epitaxial Planar Silicon Transistors

T-29-15

## Very Low Noise Amp Applications

©431D

The 2SC1570, 1571, 1571L are developed as very low-noise transistors and are especially suited for use in equalizer first stage of high-grade type stereo sets.

Absolute Maximum Ratings at Ta=25°C		2SC1570	2SC1571	2SC1571L	unit
Collector to Base Voltage	V <sub>CBO</sub>	55	40	40	V
Collector to Emitter Voltage	V <sub>CEO</sub>	50	35	35	V
Emitter to Base Voltage	V <sub>EBO</sub>		5		V
Collector Current	I <sub>C</sub>		100		mA
Allowable Power Dissipation	P <sub>C</sub>		200		mW
Junction Temperature	T <sub>J</sub>		125		°C
Storage Temperature	T <sub>stg</sub>		-55 to +150		°C

Electrical Characteristics at Ta=25°C		min	typ	max	unit
Collector Cutoff Current	I <sub>CBO</sub> V <sub>CB</sub> =18V, I <sub>E</sub> =0			0.1	uA
Emitter Cutoff Current	I <sub>EBO</sub> V <sub>EB</sub> =3V, I <sub>C</sub> =0			0.1	uA
DC Current Gain	h <sub>FE</sub> V <sub>CE</sub> =6V, I <sub>C</sub> =1mA	160*		960*	
Gain Bandwidth Product	f <sub>T</sub> V <sub>CE</sub> =6V, I <sub>C</sub> =1mA		100		MHz
Output Capacitance	c <sub>ob</sub> V <sub>CB</sub> =6V, f=1MHz		3		pF
C-E Saturation Voltage	V <sub>CE(sat)</sub> I <sub>C</sub> =50mA, I <sub>B</sub> =5mA			0.5	V
Base to Emitter Voltage	V <sub>BE</sub> V <sub>CE</sub> =2V, I <sub>C</sub> =1mA	0.58	0.80		V
C-B Breakdown Voltage	V <sub>(BR)CBO</sub> I <sub>C</sub> =10uA, I <sub>B</sub> =0			[C1570] 55	V
				[C1571, 1571L] 40	V
C-E Breakdown Voltage	V <sub>(BR)CEO</sub> I <sub>C</sub> =1mA, R <sub>BF</sub> =∞			[C1570] 50	V
				[C1571, 1571L] 35	V
E-B Breakdown Voltage	V <sub>(BR)EBO</sub> I <sub>E</sub> =10uA, I <sub>C</sub> =0			5	V
Noise Voltage	at test circuit [C1570, 1571]			40	mV
	V <sub>cc</sub> =30V, I <sub>C</sub> =1mA [C1571L]			65	mV
	R <sub>g</sub> =56kohm, V <sub>G</sub> =77dB (at 1kHz)				
Noise Peak Level	" " [C1570, 1571]			280	mV
	" " [C1571L]			450	mV

\*:The 2SC1570, 1571, 1571L are classified by 1mA h<sub>FE</sub> as follows:

160	F	320	280	G	560	480	H	960
-----	---	-----	-----	---	-----	-----	---	-----

### Noise Test Circuit

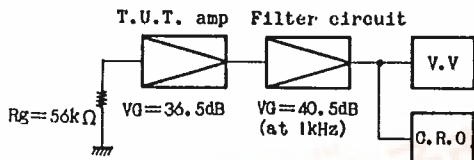

### Case Outline 2003A (unit:mm)

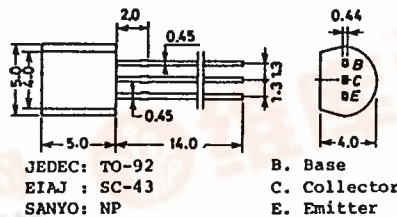

2SC1570, 1571, 1571L

(T-29-15)

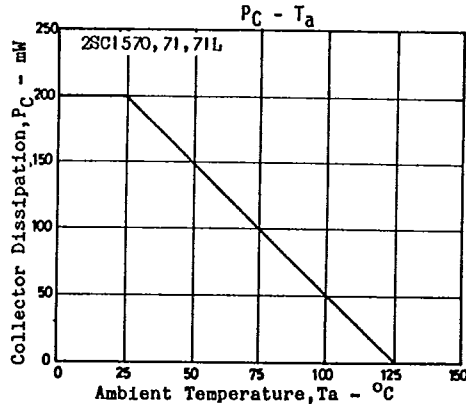
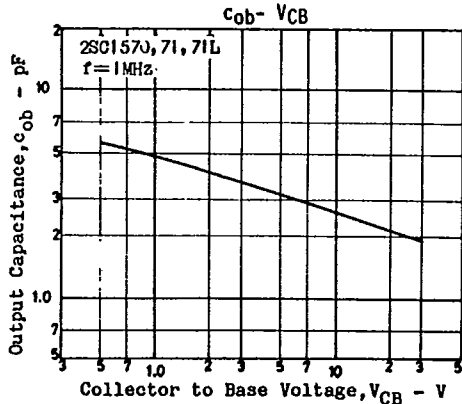
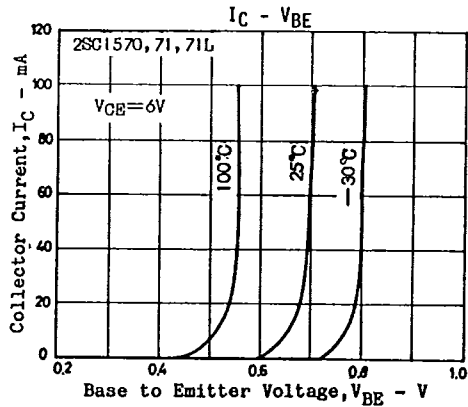
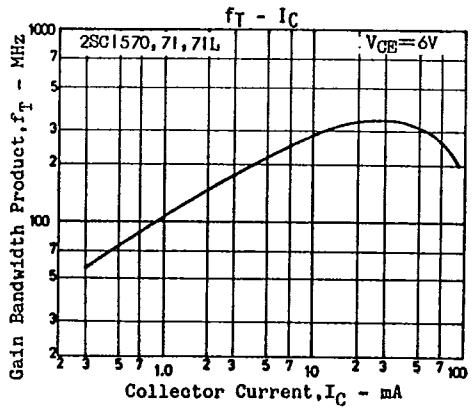
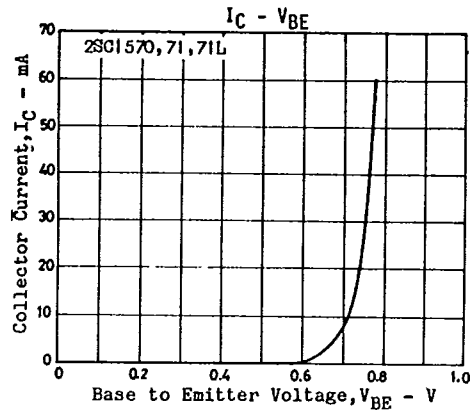
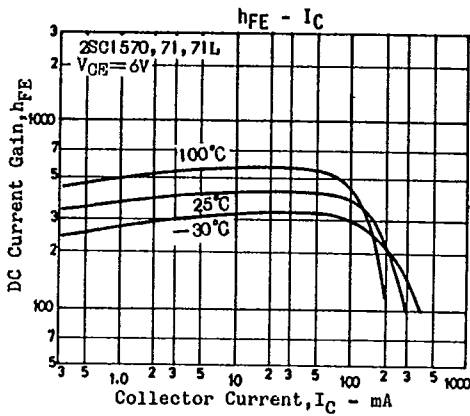
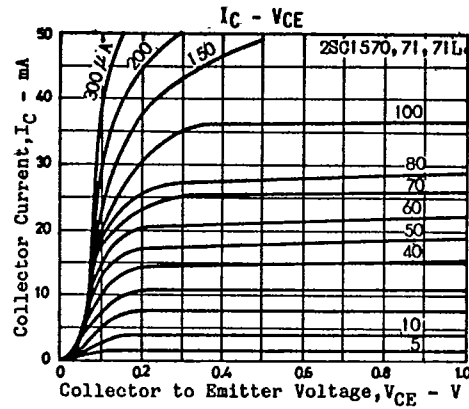
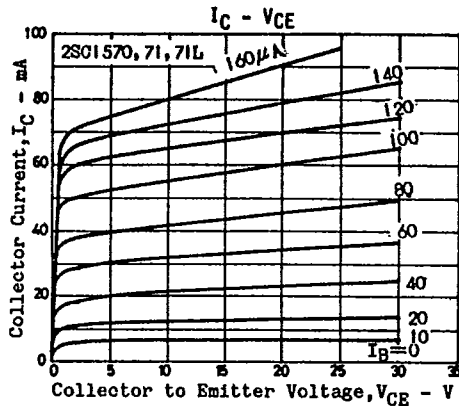

2SC1570,1571,1571L

(T-29-15)

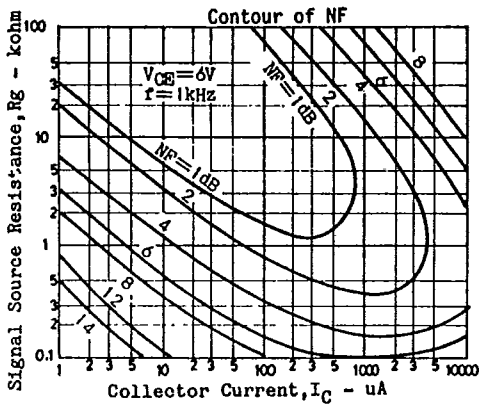
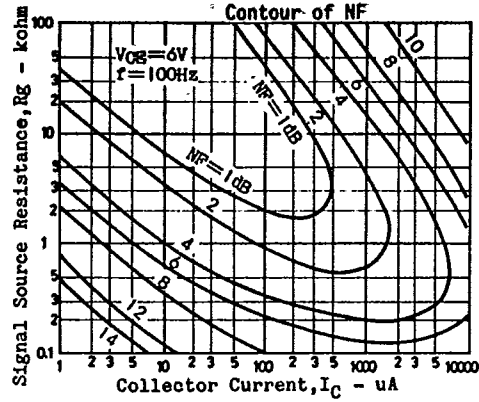
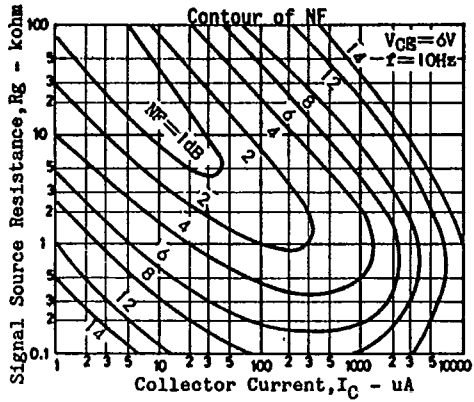

T-91-20

## CASE OUTLINES AND ATTACHMENTS

- All of Sanyo Transistor case outlines are illustrated below.
- All dimensions are in mm, and dimensions which are not followed by min. or max. are represented by typical values.
- No marking is indicated.

Case Outline-[2003A]  
unit:mm

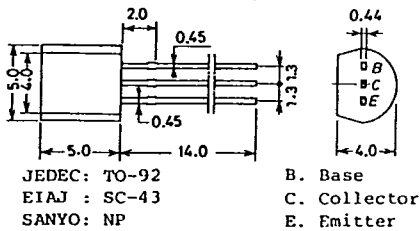

Case Outline-[2009A]  
unit:mm

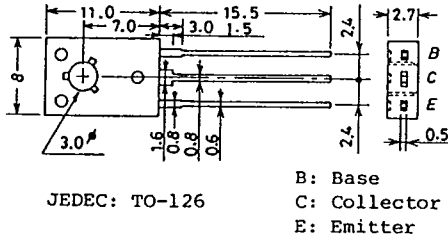

Case Outline-[2004A]  
unit:mm

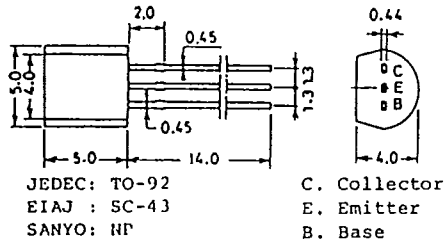

Case Outline-[2010A]  
unit:mm

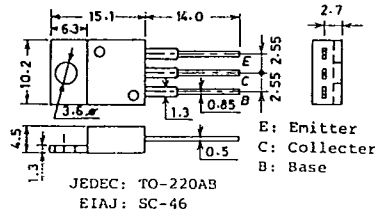

Case Outline-[2005A]  
unit:mm

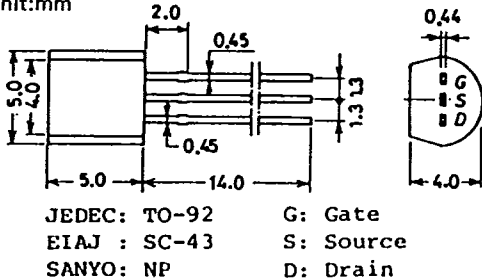

Case Outline-[2012]  
unit:mm

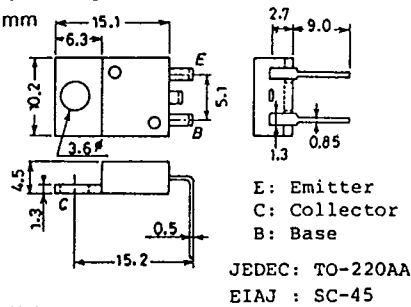

Case Outline-[2006A]  
unit:mm

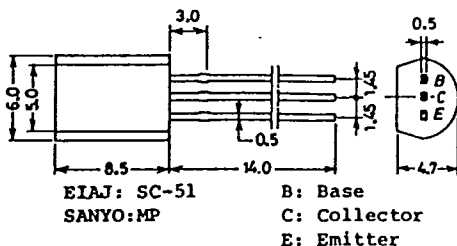

Case Outline-[2013]  
unit:mm

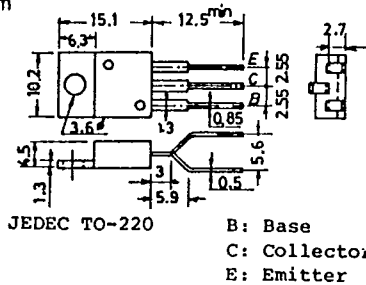

Case Outline-[2017]  
unit:mm

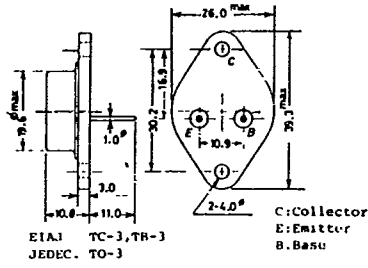

Case Outline-[2025]  
unit:mm

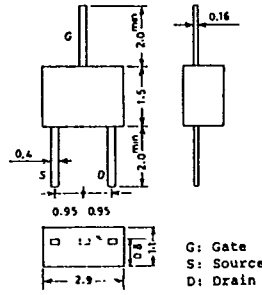

Case Outline-[2018A]  
unit:mm

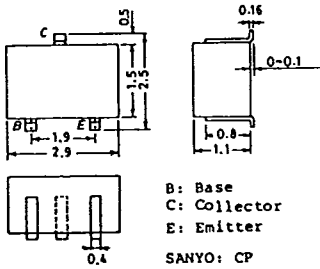

Case Outline-[2026]  
unit:mm

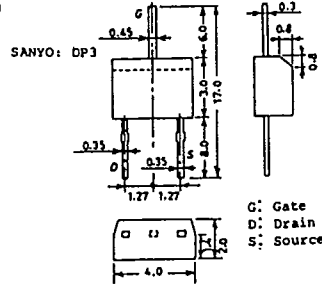

Case Outline-[2019A]  
unit:mm

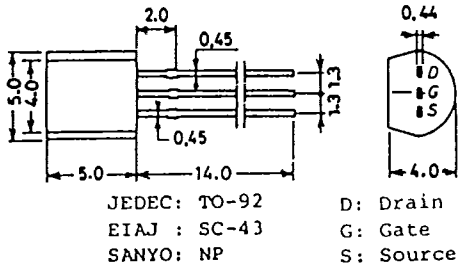

Case Outline-[2027A]  
unit:mm

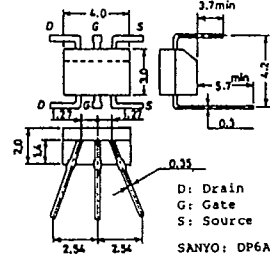

Case Outline-[2022]  
unit:mm

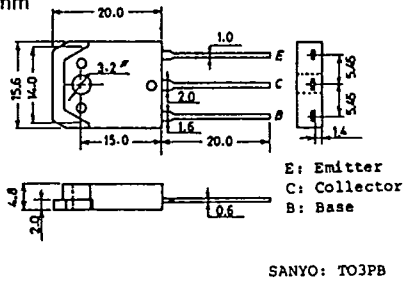

Case Outline-[2028A]  
unit:mm

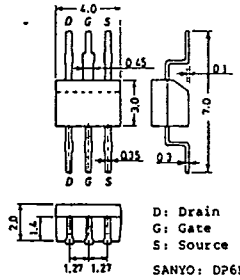

Case Outline-[2024A]  
unit:mm

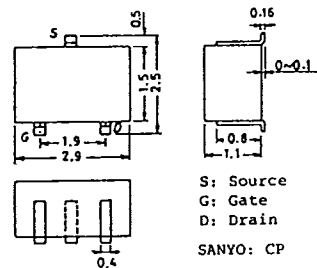

Case Outline-[2029A]  
unit:mm

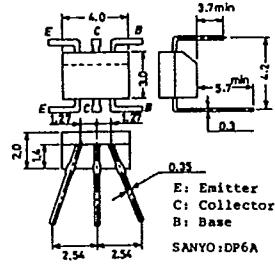

T-91-20

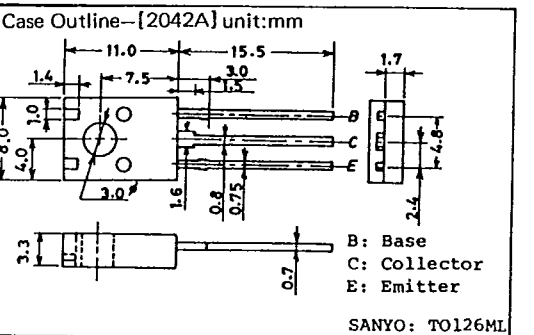
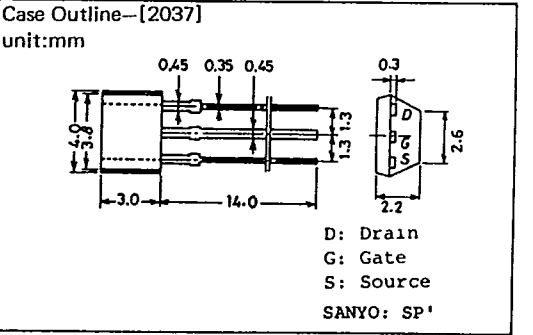
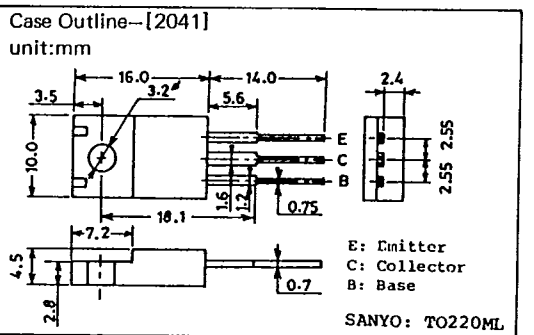
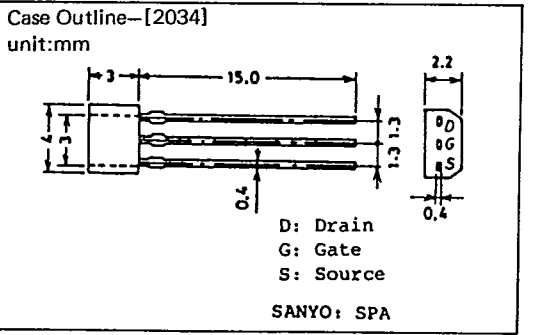
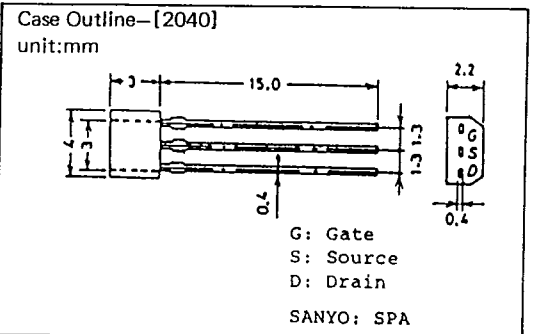
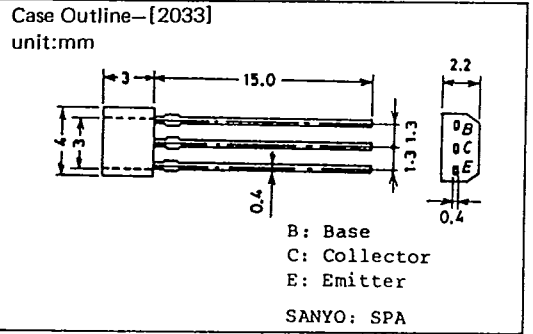
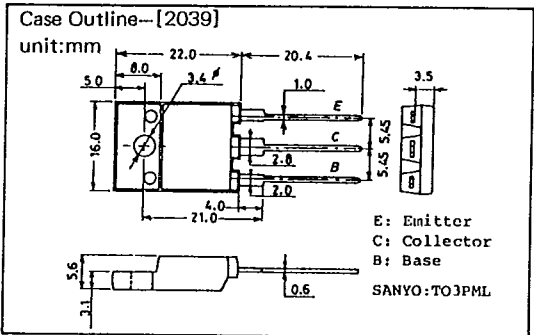
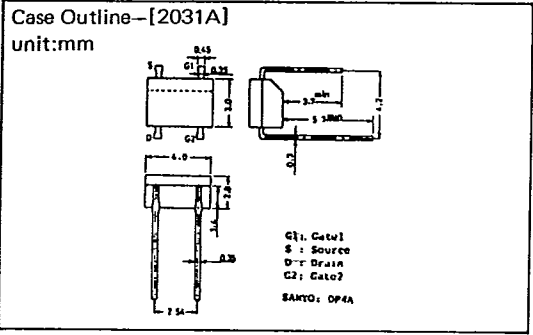
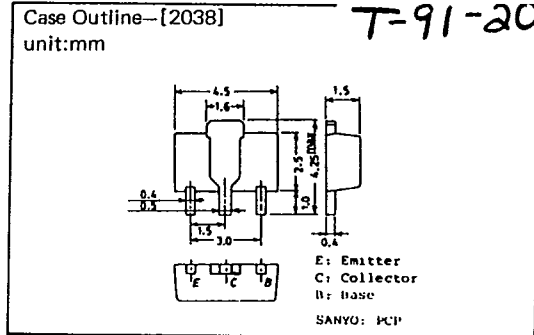
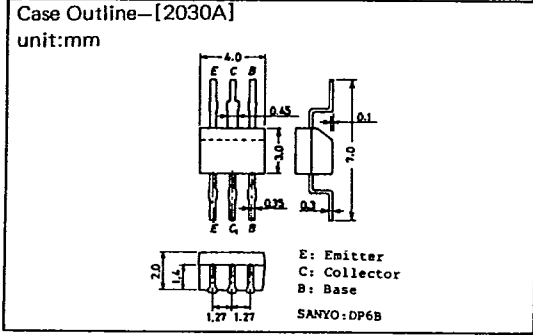

T-91-20

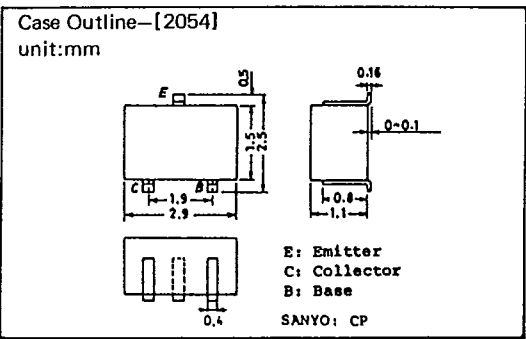
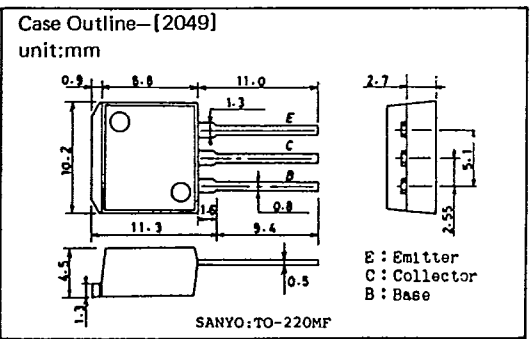
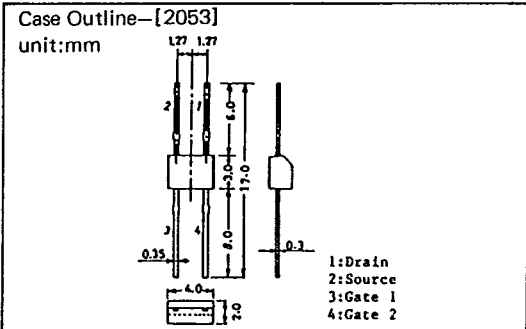
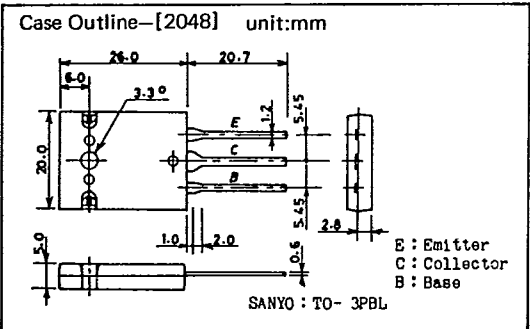
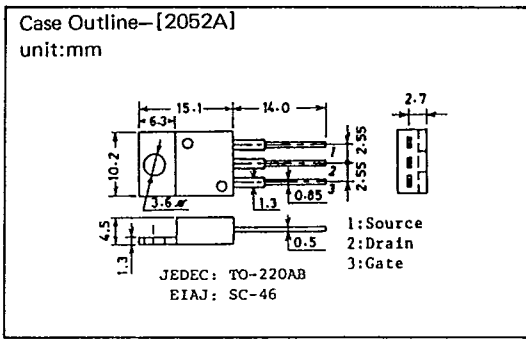
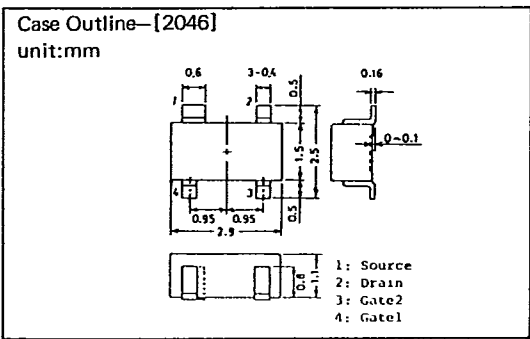
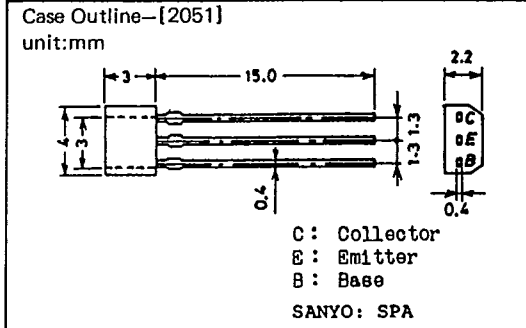
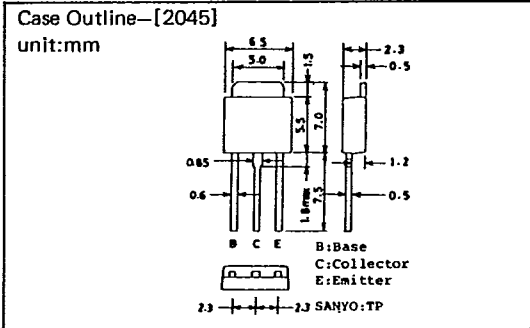
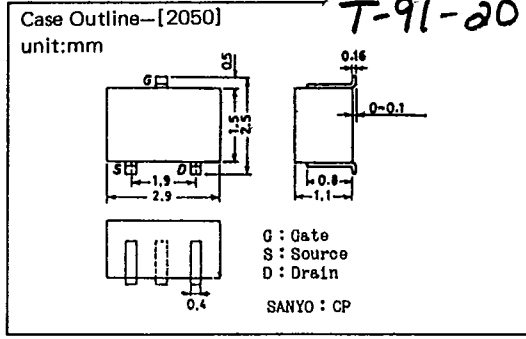
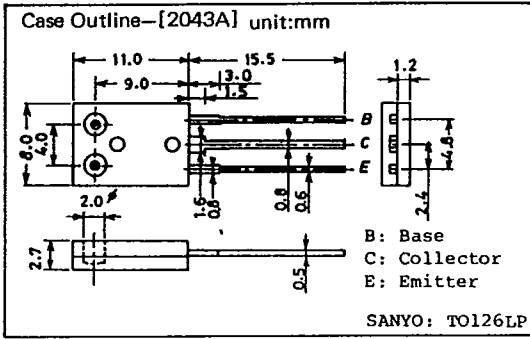

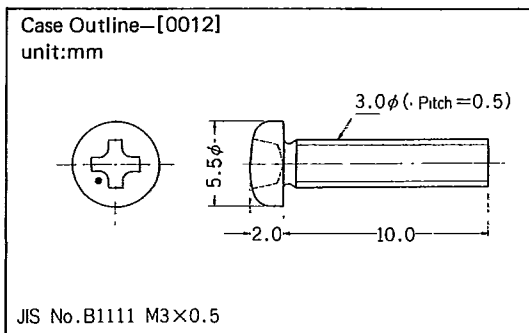
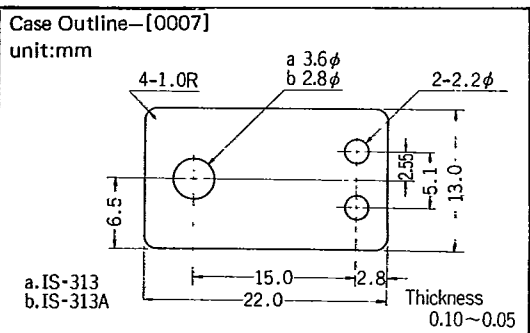
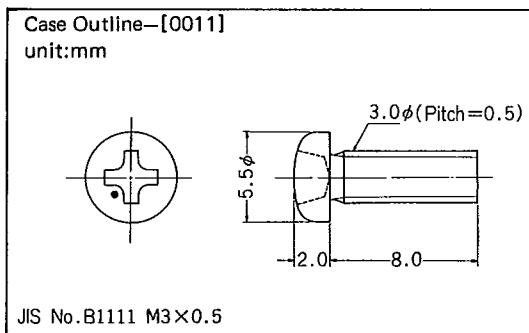
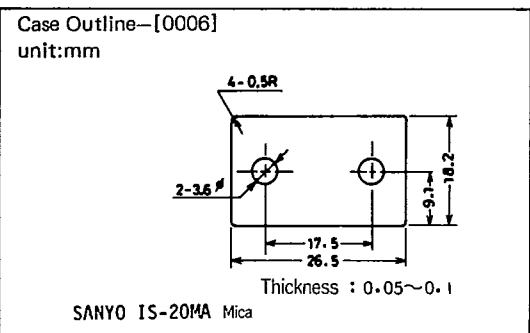
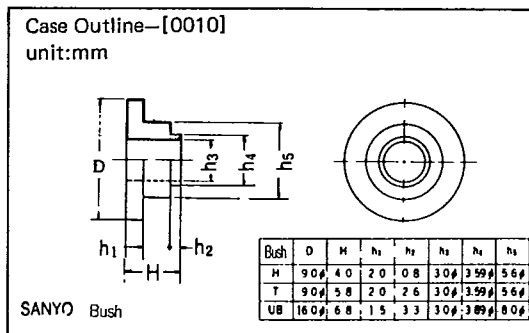
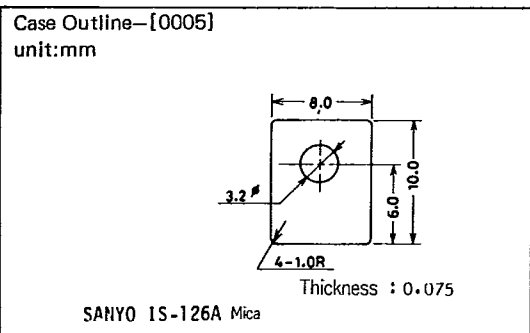
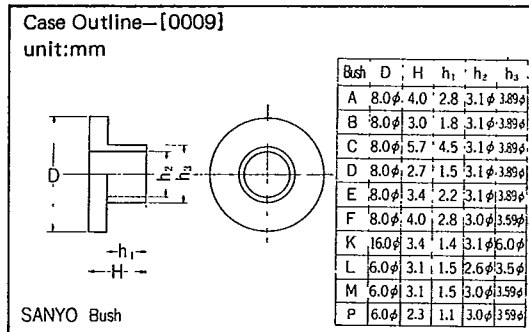
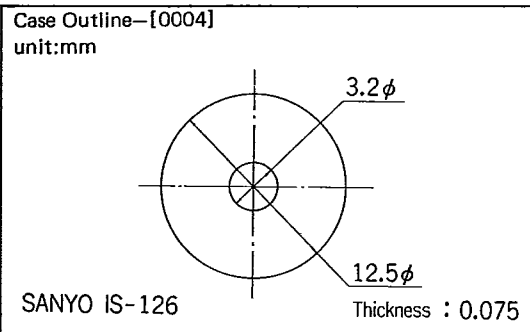
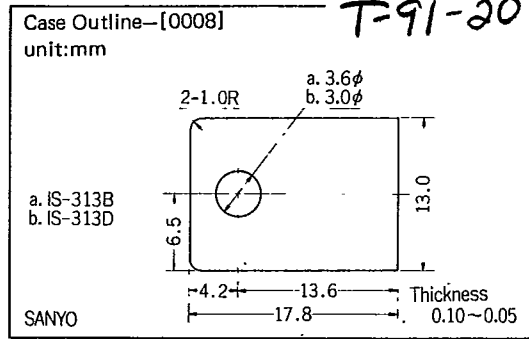
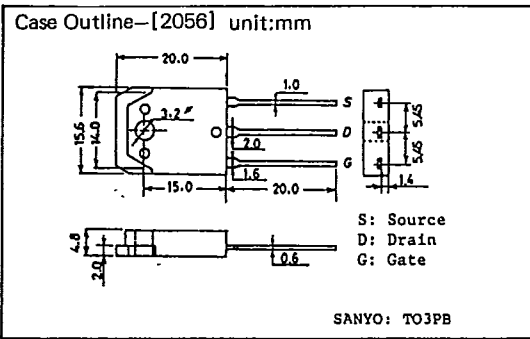



Case Outline-[0013]  
unit:mm

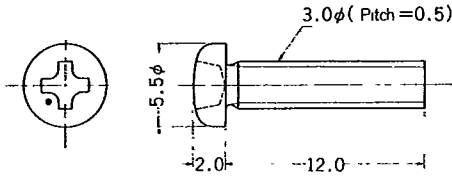

JIS No. B1111 M3×0.5

Case Outline-[0018]  
unit:mm

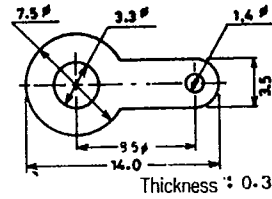

SANYO Lug 1.4

Case Outline-[0014]  
unit:mm

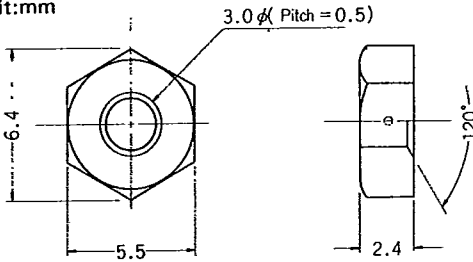

JIS No. B1181 M3×0.5

Case Outline-[0019]  
unit:mm

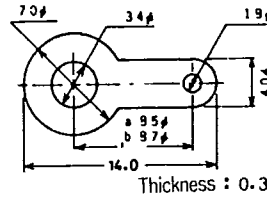

SANYO Lug 1.8φ

Case Outline-[0015]  
unit:mm

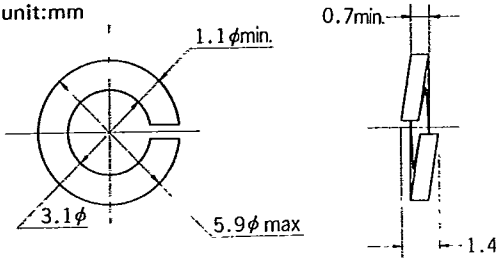

JIS No. B 1251 Spring washer (M3)

Case Outline-[0020]  
unit:mm

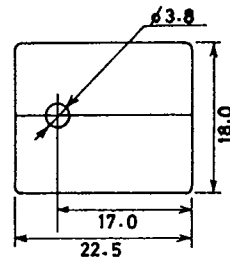

SANYO IS-3MP Mica

Case Outline-[0016]  
unit:mm

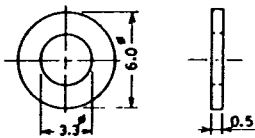

JIS No. B1252 Flat washer

Case Outline-[0021]  
unit:mm

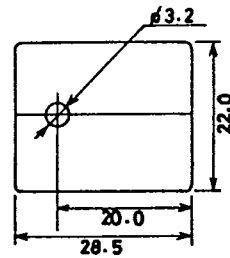

SANYO IS-MPC Mica

Case Outline-[0017]  
unit:mm

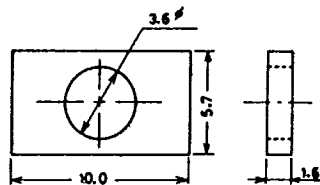

JIS No. G3141 Rectangular washer

Case Outline-[0022]  
unit:mm

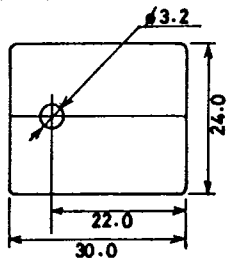

SANYO IS-3PBL Mica