

> **Features**

- High Current
- Low On-Resistance
- No Secondary Breakdown
- Low Driving Power
- High Forward Transconductance

> **Applications**

- Motor Control
- General Purpose Power Amplifier
- DC-DC converters

> **Maximum Ratings and Characteristics**

- Absolute Maximum Ratings ($T_C=25^\circ\text{C}$), unless otherwise specified

Item	Symbol	Rating	Unit
Drain-Source-Voltage	V_{DS}	150	V
Continous Drain Current	I_D	3	A
Pulsed Drain Current	$I_{D(puls)}$	12	A
Continous Reverse Drain Current	I_{DR}	3	A
Gate-Source-Voltage	V_{GS}	± 20	V
Max. Power Dissipation	P_D	20	W
Operating and Storage Temperature Range	T_{ch}	150	$^\circ\text{C}$
	T_{stg}	-55 ~ +150	$^\circ\text{C}$

- Electrical Characteristics ($T_C=25^\circ\text{C}$), unless otherwise specified

Item	Symbol	Test conditions	Min.	Typ.	Max.	Unit
Drain-Source Breakdown-Voltage	$V_{(BR)DSS}$	$I_D=1\text{mA}$ $V_{GS}=0\text{V}$	150			V
Gate Threshold Voltage	$V_{GS(th)}$	$I_D=1\text{mA}$ $V_{DS}=V_{GS}$	1,0	1,5	2,5	V
Zero Gate Voltage Drain Current	I_{DSS}	$V_{DS}=150\text{V}$ $T_{ch}=25^\circ\text{C}$		10	500	μA
		$V_{GS}=0\text{V}$ $T_{ch}=125^\circ\text{C}$		0,2	1,0	mA
Gate Source Leakage Current	I_{GSS}	$V_{GS}=\pm 20\text{V}$ $V_{DS}=0\text{V}$		10	100	nA
Drain Source On-State Resistance	$R_{DS(on)}$	$I_D=1,5\text{A}$ $V_{GS}=4\text{V}$		0,72	1,17	Ω
		$I_D=1,5\text{A}$ $V_{GS}=10\text{V}$		0,60	0,90	Ω
Forward Transconductance	g_{fs}	$I_D=1,5\text{A}$ $V_{DS}=25\text{V}$	1,5	3		S
Input Capacitance	C_{iss}	$V_{DS}=25\text{V}$		350	530	pF
Output Capacitance	C_{oss}	$V_{GS}=0\text{V}$		60	90	pF
Reverse Transfer Capacitance	C_{rss}	$f=1\text{MHz}$		15	23	pF
Turn-On-Time t_{on} ($t_{on}=t_{d(on)}+t_r$)	$t_{d(on)}$	$V_{CC}=30\text{V}$		3	5	ns
	t_r	$I_D=3\text{A}$		30	45	ns
Turn-Off-Time t_{off} ($t_{off}=t_{d(off)}+t_f$)	$t_{d(off)}$	$V_{GS}=10\text{V}$		60	90	ns
	t_f	$R_{GS}=25\Omega$		20	30	ns
Diode Forward On-Voltage	V_{SD}	$I_F=2I_{DR}$ $V_{GS}=0\text{V}$ $T_{ch}=25^\circ\text{C}$		0,95	1,43	V
Reverse Recovery Time	t_{rr}	$I_F=I_{DR}$ $V_{GS}=0\text{V}$		70		ns
		$-di_F/dt=100\text{A}/\mu\text{s}$ $T_{ch}=25^\circ\text{C}$				

- Thermal Characteristics

Item	Symbol	Test conditions	Min.	Typ.	Max.	Unit
Thermal Resistance	$R_{th(ch-a)}$	channel to air			62,5	$^\circ\text{C}/\text{W}$
	$R_{th(ch-c)}$	channel to case			6,25	$^\circ\text{C}/\text{W}$

> **Outline Drawing**

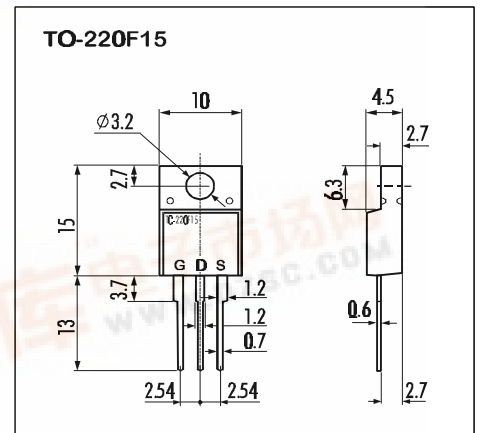

> **Equivalent Circuit**

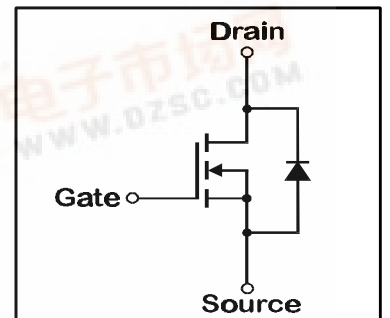

N-channel MOS-FET			
150V	0,9Ω	3A	20W

2SK1085-M

F-III Series



> Characteristics

Typical Output Characteristics

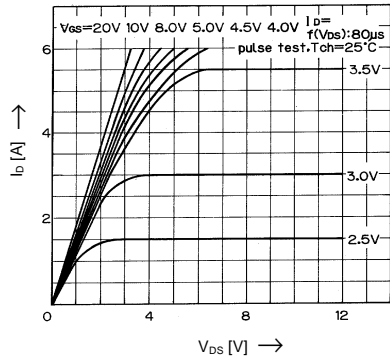

Drain-Source-On-State Resistance vs. T_{ch}

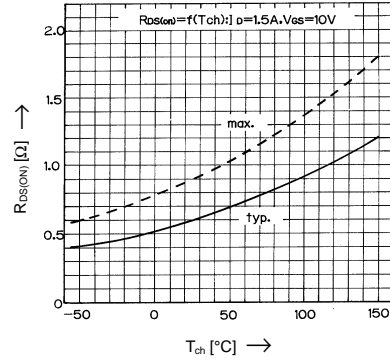

Typical Transfer Characteristics

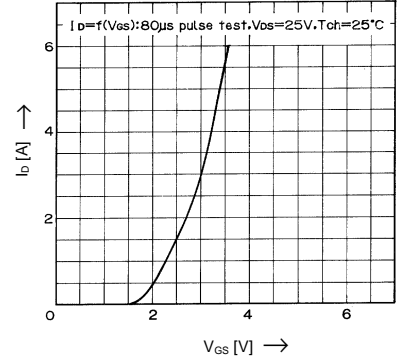

Typical Drain-Source-On-State-Resistance vs. Id

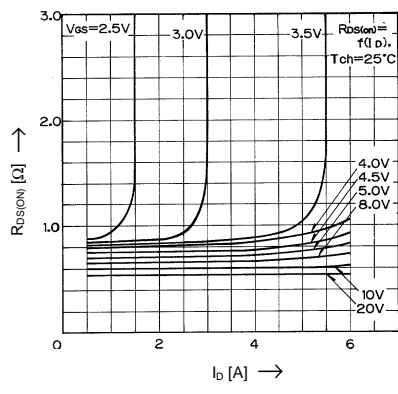

Typical Forward Transconductance vs. Id

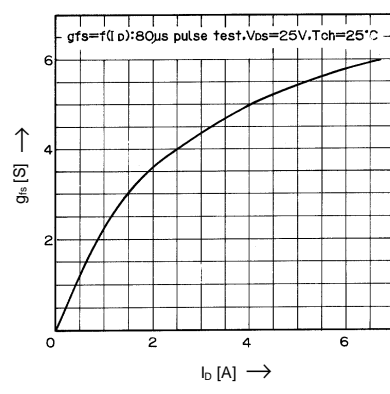

Gate Threshold Voltage vs. T_{ch}

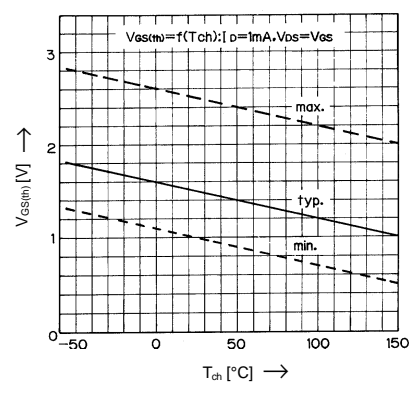

Typical Capacitance vs. V_{DS}

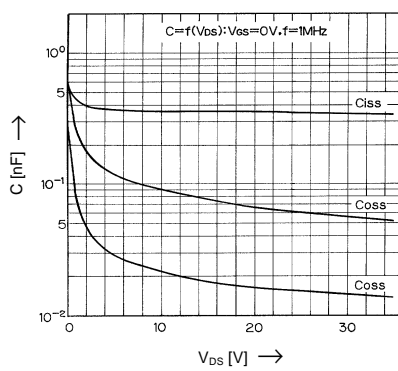

Typical Input Charge

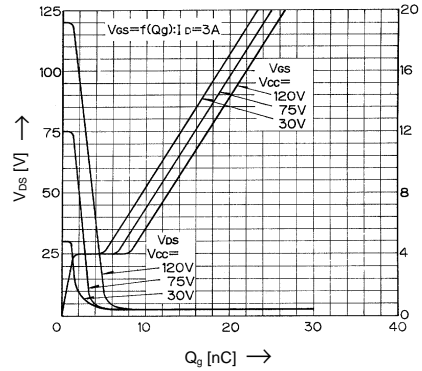

Forward Characteristics of Reverse Diode

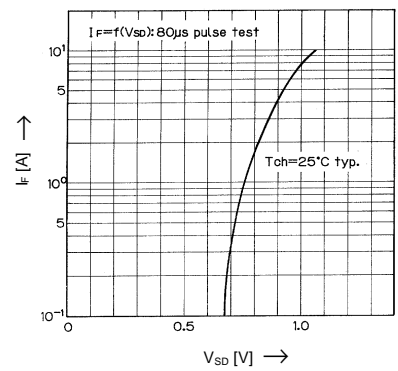

Allowable Power Dissipation vs. T_c

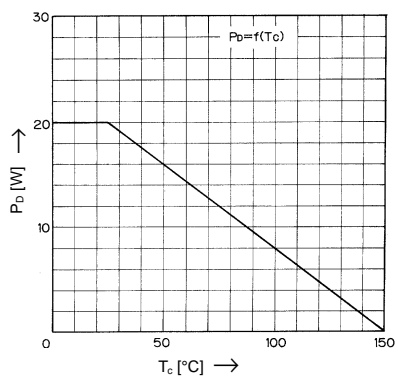

Safe operation area

