

> **Features**

- High Current
- Low On-Resistance
- No Secondary Breakdown
- Low Driving Power
- High Forward Transconductance

> **Applications**

- Motor Control
- General Purpose Power Amplifier
- DC-DC converters

> **Outline Drawing**

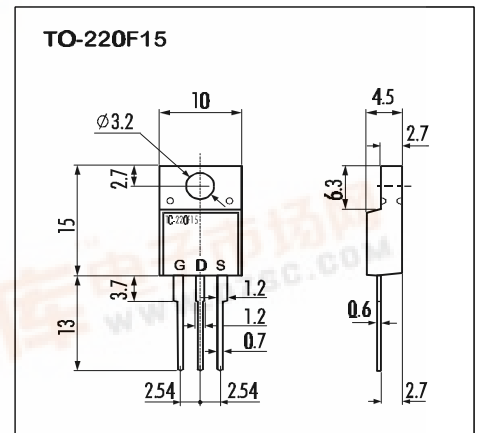

> **Maximum Ratings and Characteristics**

- Absolute Maximum Ratings ( $T_C=25^\circ\text{C}$ ), unless otherwise specified

Item	Symbol	Rating	Unit
Drain-Source-Voltage	$V_{DS}$	150	V
Continuous Drain Current	$I_D$	6	A
Pulsed Drain Current	$I_{D(puls)}$	24	A
Continuous Reverse Drain Current	$I_{DR}$	6	A
Gate-Source-Voltage	$V_{GS}$	$\pm 20$	V
Max. Power Dissipation	$P_D$	30	W
Operating and Storage Temperature Range	$T_{ch}$	150	$^\circ\text{C}$
	$T_{stg}$	-55 ~ +150	$^\circ\text{C}$

> **Equivalent Circuit**

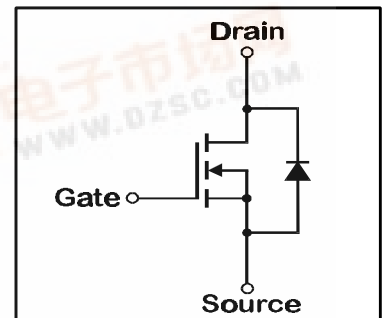

- Electrical Characteristics ( $T_C=25^\circ\text{C}$ ), unless otherwise specified

Item	Symbol	Test conditions	Min.	Typ.	Max.	Unit
Drain-Source Breakdown-Voltage	$V_{(BR)DSS}$	$I_D=1\text{mA}$ $V_{GS}=0\text{V}$	150			V
Gate Threshold Voltage	$V_{GS(th)}$	$I_D=1\text{mA}$ $V_{DS}=V_{GS}$	1,0	1,5	2,5	V
Zero Gate Voltage Drain Current	$I_{DSS}$	$V_{DS}=150\text{V}$ $T_{ch}=25^\circ\text{C}$		10	500	$\mu\text{A}$
		$V_{GS}=0\text{V}$ $T_{ch}=125^\circ\text{C}$		0,2	1,0	mA
Gate Source Leakage Current	$I_{GSS}$	$V_{GS}=\pm 20\text{V}$ $V_{DS}=0\text{V}$		10	100	nA
Drain Source On-State Resistance	$R_{DS(on)}$	$I_D=3\text{A}$ $V_{GS}=4\text{V}$		0,40	0,65	$\Omega$
		$I_D=3\text{A}$ $V_{GS}=10\text{V}$		0,33	0,50	$\Omega$
Forward Transconductance	$g_{fs}$	$I_D=3\text{A}$ $V_{DS}=25\text{V}$	3	6		S
Input Capacitance	$C_{iss}$	$V_{DS}=25\text{V}$		600	900	pF
Output Capacitance	$C_{oss}$	$V_{GS}=0\text{V}$		100	150	pF
Reverse Transfer Capacitance	$C_{rss}$	$f=1\text{MHz}$		30	45	pF
Turn-On-Time $t_{on}$ ( $t_{on}=t_{d(on)}+t_r$ )	$t_{d(on)}$	$V_{CC}=30\text{V}$		10	15	ns
	$t_r$	$I_D=6\text{A}$		40	60	ns
Turn-Off-Time $t_{off}$ ( $t_{off}=t_{d(off)}+t_f$ )	$t_{d(off)}$	$V_{GS}=10\text{V}$		90	120	ns
	$t_f$	$R_{GS}=25\Omega$		30	50	ns
Diode Forward On-Voltage	$V_{SD}$	$I_F=2 \times I_{DR}$ $V_{GS}=0\text{V}$ $T_{ch}=25^\circ\text{C}$		1,01	1,52	V
Reverse Recovery Time	$t_{rr}$	$I_F=I_{DR}$ $V_{GS}=0\text{V}$		80		ns
		$-di_F/dt=100\text{A}/\mu\text{s}$ $T_{ch}=25^\circ\text{C}$				

- Thermal Characteristics

Item	Symbol	Test conditions	Min.	Typ.	Max.	Unit
Thermal Resistance	$R_{th(ch-a)}$	channel to air			62,5	$^\circ\text{C}/\text{W}$
	$R_{th(ch-c)}$	channel to case			4,17	$^\circ\text{C}/\text{W}$



N-channel MOS-FET			
150V	0,5Ω	6A	30W

# 2SK1098-M

## F-III Series



### > Characteristics

Typical Output Characteristics

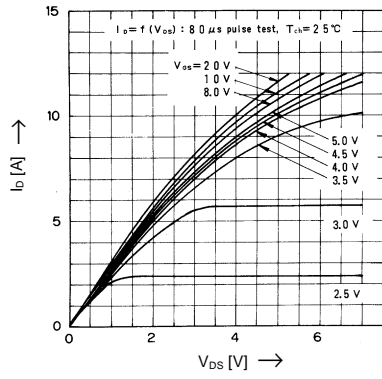

Drain-Source-On-State Resistance vs. T<sub>ch</sub>

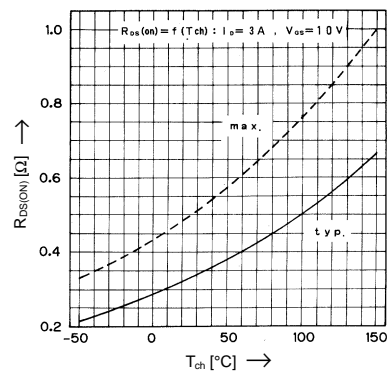

Typical Transfer Characteristics

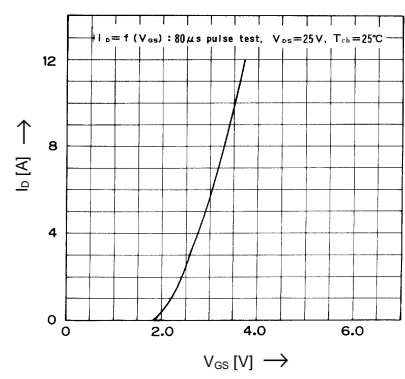

Typical Drain-Source-On-State-Resistance vs. I<sub>D</sub>

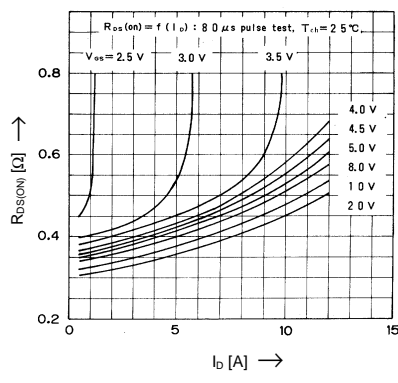

Typical Forward Transconductance vs. I<sub>D</sub>

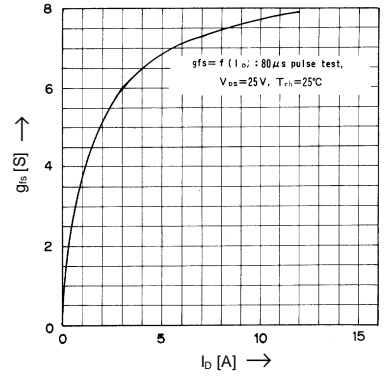

Gate Threshold Voltage vs. T<sub>ch</sub>

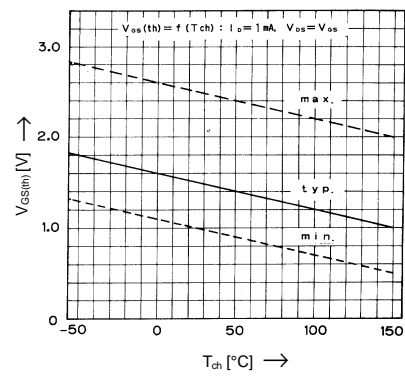

Typical Capacitance vs. V<sub>DS</sub>

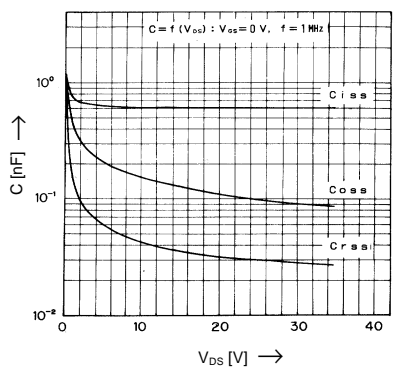

Typical Input Charge

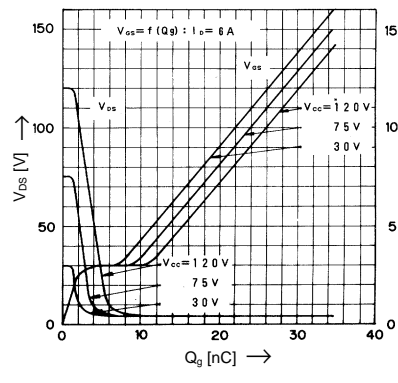

Forward Characteristics of Reverse Diode

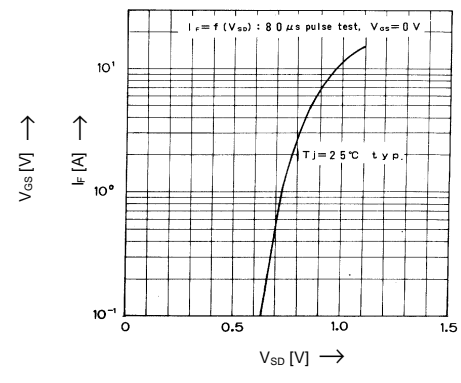

Allowable Power Dissipation vs. T<sub>c</sub>

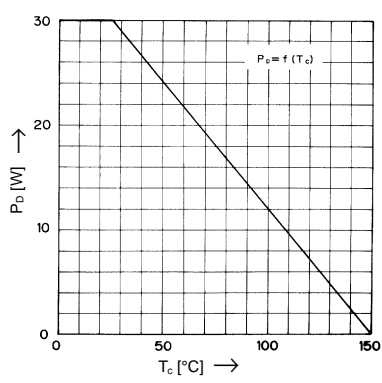

Safe operation area

