

2W005G THRU 2W10G

GLASS PASSIVATED SINGLE-PHASE BRIDGE RECTIFIER

Reverse Voltage - 50 to 1000 Volts Forward Current - 2.0 Amperes

Case Style W0G

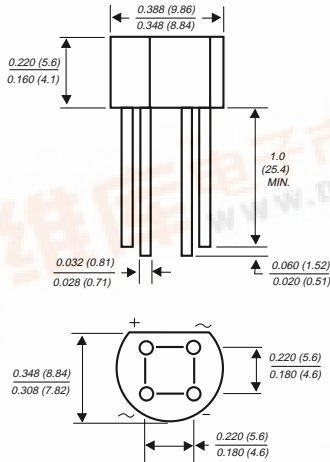

Dimensions in inches and (millimeters)

FEATURES

- ◆ Plastic package has Underwriters Laboratory Flammability Recognition 94V-0
- ◆ This series is UL listed under the Recognized Component Index, file number E54214
- ◆ Glass passivated chip junctions
- ◆ High case dielectric strength
- ◆ Typical I_R less than $0.5\mu A$
- ◆ High surge current capability
- ◆ Ideal for printed circuit boards
- ◆ High temperature soldering guaranteed:
260°C for 10 seconds, 0.375" (9.5mm) lead length, 5lbs. (2.3kg) tension

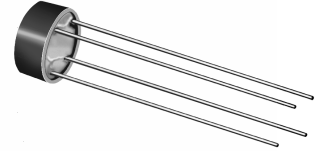

MECHANICAL DATA

Case: Molded plastic body over passivated junctions

Terminals: Plated leads, solderable per MIL-STD-750, Method 2026

Mounting Position: Any

Weight: 0.04 ounce, 1.1 grams

MAXIMUM RATINGS AND ELECTRICAL CHARACTERISTICS

Ratings at 25°C ambient temperature unless otherwise specified.

	SYMBOLS	2W 005G	2W 01G	2W 02G	2W 04G	2W 06G	2W 08G	2W 10G	UNITS
Maximum repetitive peak reverse voltage	V _{RRM}	50	100	200	400	600	800	1000	Volts
Maximum RMS voltage	V _{RMS}	35	70	140	280	420	560	700	Volts
Maximum DC blocking voltage	V _{DC}	50	100	200	400	600	800	1000	Volts
Maximum average forward rectified current 0.375" (9.5mm) lead length (SEE FIG. 1)	I _(AV)	2.0							Amps
Peak forward surge current single sine-wave superimposed on rated load (JEDEC Method)	I _{FSM}	60.0							Amps
Rating for fusing (t<8.3ms)	I ² t	15.0							A ² sec
Maximum instantaneous forward voltage drop per leg at 2.0 Amperes	V _F	1.1							Volts
Maximum DC reverse current at rated DC blocking voltage per leg	I _R	5.0 500.0							μA
Typical junction capacitance per leg (NOTE 1)	C _J	40.0				20.0			pF
Typical thermal resistance per leg (NOTE 2)	R _{θJA} R _{θJL}	40.0 15.0							°C/W
Operating junction temperature range	T _J	-55 to +150							°C
Storage temperature range	T _{STG}	-55 to +150							°C

(1) Measured at 1.0 MHz and applied reverse voltage of 4.0 Volts

(2) Thermal resistance from junction to ambient and from junction to lead at 0.375" (9.5mm) lead length for P.C.B. mounting



RATINGS AND CHARACTERISTICS CURVES 2W005G THRU 2W10G

FIG. 1 - DERATING CURVE OUTPUT RECTIFIED CURRENT

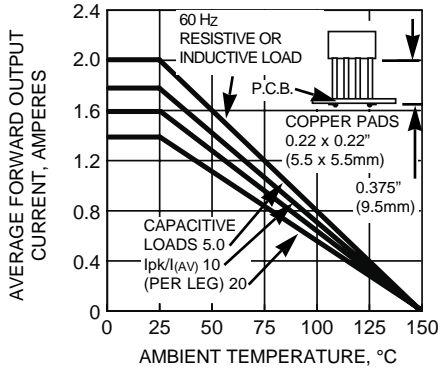

FIG. 2 - MAXIMUM NON-REPETITIVE PEAK FORWARD SURGE CURRENT PER LEG

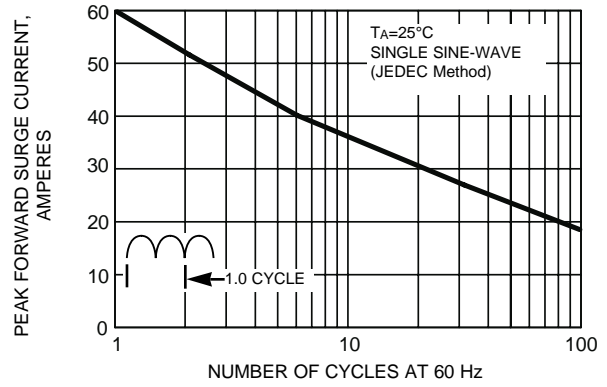

FIG. 3 - TYPICAL FORWARD CHARACTERISTICS PER LEG

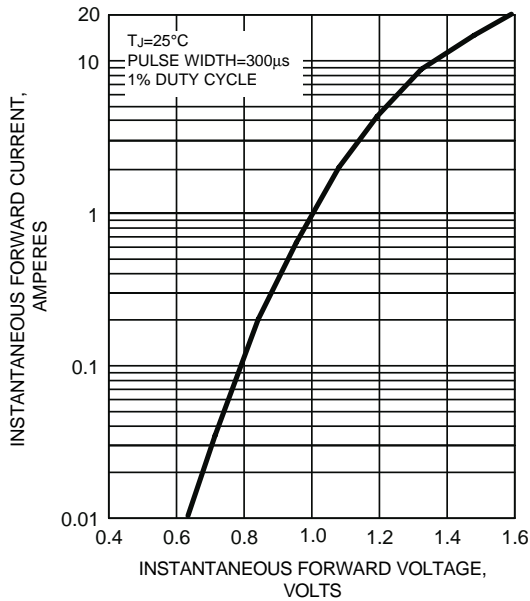

FIG. 4 - TYPICAL REVERSE CHARACTERISTICS PER LEG

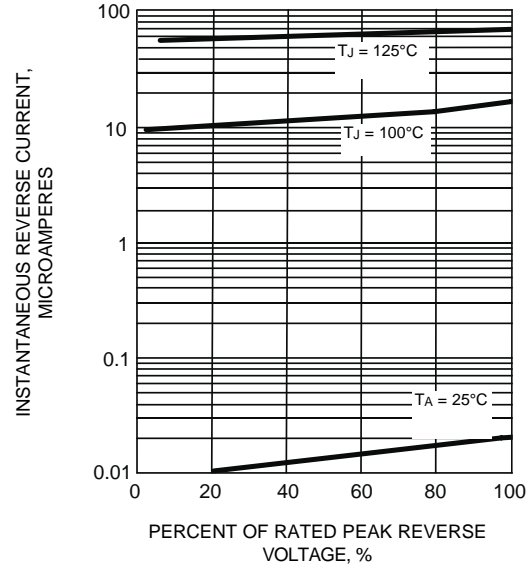

FIG. 5 - TYPICAL JUNCTION CAPACITANCE PER LEG

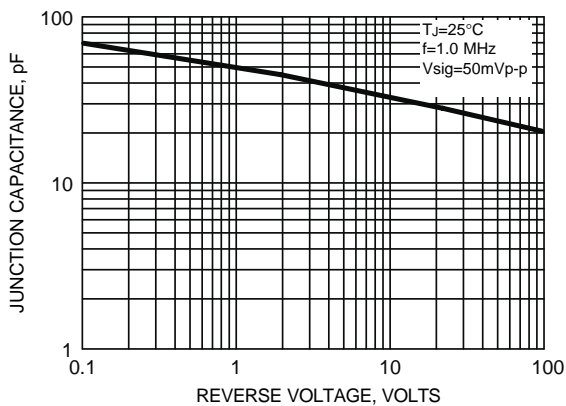

FIG. 6 - TYPICAL TRANSIENT THERMAL IMPEDANCE

