

Bulletin PD-20606 rev. B 01/04

International IR Rectifier

30CTQ...
30CTQ...S
30CTQ...-1

SCHOTTKY RECTIFIER

30 Amp

Major Ratings and Characteristics

Characteristics	Values	Units
$I_{F(AV)}$ Rectangular waveform	30	A
V_{RRM}	80 - 100	V
I_{FSM} @ $t_p = 5 \mu s$ sine	850	A
V_F @ 15 Apk, $T_J = 125^\circ C$ (per leg)	0.67	V
T_J range	-55 to 175	$^\circ C$

Description/ Features

This center tap Schottky rectifier series has been optimized for low reverse leakage at high temperature. The proprietary barrier technology allows for reliable operation up to 175°C junction temperature. Typical applications are in switching power supplies, converters, free-wheeling diodes, and reverse battery protection.

- 175°C T_J operation
- Center tap configuration
- Low forward voltage drop
- High purity, high temperature epoxy encapsulation for enhanced mechanical strength and moisture resistance
- High frequency operation
- Guard ring for enhanced ruggedness and long term reliability

Case Styles

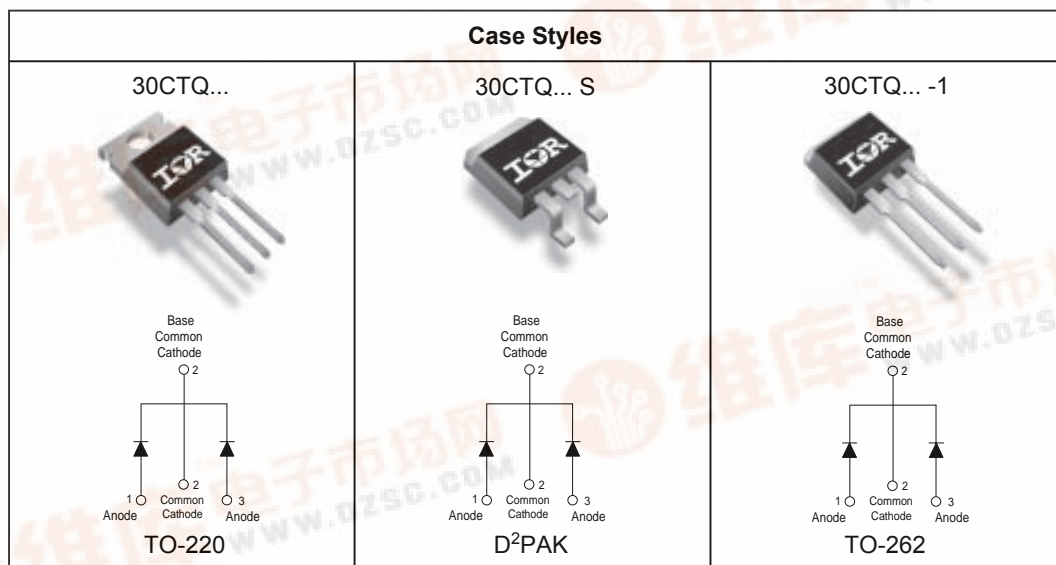

Voltage Ratings

Parameters	30CTQ80 30CTQ80S 30CTQ80-1	30CTQ100 30CTQ100S 30CTQ100-1
V_R Max. DC Reverse Voltage (V)	80	100
V_{RWM} Max. Working Peak Reverse Voltage (V)		

Absolute Maximum Ratings

Parameters	Values	Units	Conditions
$I_{F(AV)}$ Max. Average Forward (Per Leg) Current * See Fig. 5 (Per Device)	15	A	50% duty cycle @ $T_C = 129^\circ\text{C}$, rectangular wave form
	30		
I_{FSM} Max. Peak One Cycle Non-Repetitive Surge Current (Per Leg) * See Fig. 7	850	A	5 μs Sine or 3 μs Rect. pulse 10ms Sine or 6ms Rect. pulse
	275		
E_{AS} Non-Repetitive Avalanche Energy (Per Leg)	7.50	mJ	$T_J = 25^\circ\text{C}$, $I_{AS} = 0.50$ Amps, $L = 60$ mH
I_{AR} Repetitive Avalanche Current (Per Leg)	0.50	A	Current decaying linearly to zero in 1 μsec Frequency limited by T_J max. $V_A = 1.5 \times V_R$ typical

Electrical Specifications

Parameters	Values	Units	Conditions
V_{FM} Max. Forward Voltage Drop (Per Leg) * See Fig. 1 (1)	0.86	V	@ 15A
	1.05	V	@ 30A
	0.67	V	@ 15A
	0.82	V	@ 30A
I_{RM} Max. Reverse Leakage Current (Per Leg) * See Fig. 2 (1)	0.55	mA	$T_J = 25^\circ\text{C}$
	7.0	mA	$T_J = 125^\circ\text{C}$
C_T Max. Junction Capacitance (Per Leg)	500	pF	$V_R = 5V_{DC}$ (test signal range 100Khz to 1Mhz) 25°C
L_S Typical Series Inductance (Per Leg)	8.0	nH	Measured lead to lead 5mm from package body
dv/dt Max. Voltage Rate of Change (Rated V_R)	10000	V/ μs	

(1) Pulse Width < 300 μs , Duty Cycle < 2%

Thermal-Mechanical Specifications

Parameters	Values	Units	Conditions
T_J Max. Junction Temperature Range	-55 to 175	$^\circ\text{C}$	
T_{stg} Max. Storage Temperature Range	-55 to 175	$^\circ\text{C}$	
R_{thJC} Max. Thermal Resistance Junction to Case (Per Leg)	3.25	$^\circ\text{C}/\text{W}$	DC operation
R_{thJC} Max. Thermal Resistance Junction to Case (Per Package)	1.63	$^\circ\text{C}/\text{W}$	DC operation
R_{thCS} Typical Thermal Resistance, Case to Heatsink	0.50	$^\circ\text{C}/\text{W}$	Mounting surface, smooth and greased (only for TO-220)
wt Approximate Weight	2 (0.07)	g (oz.)	
T Mounting Torque	Min.	6 (5)	Kg-cm (lbf-in)
	Max.	12 (10)	

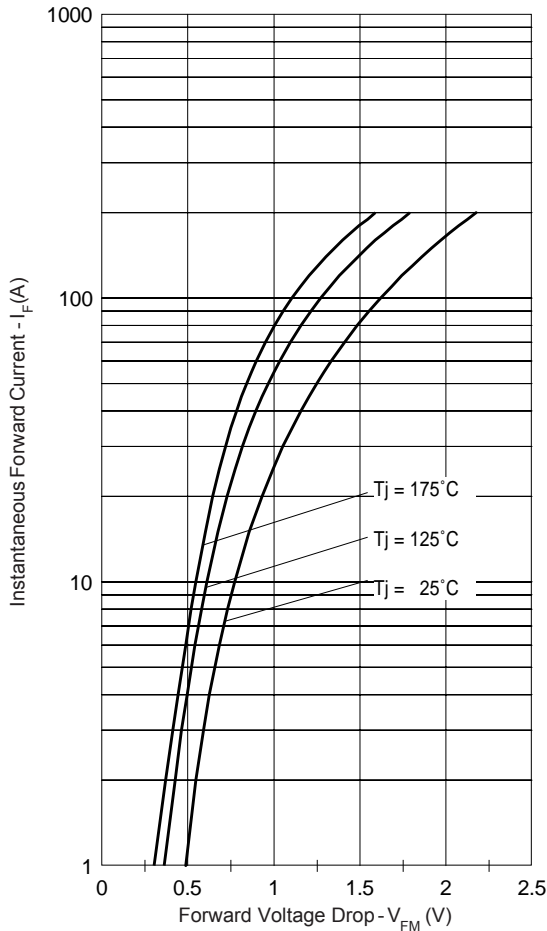

Fig. 1 - Max. Forward Voltage Drop Characteristics (Per Leg)

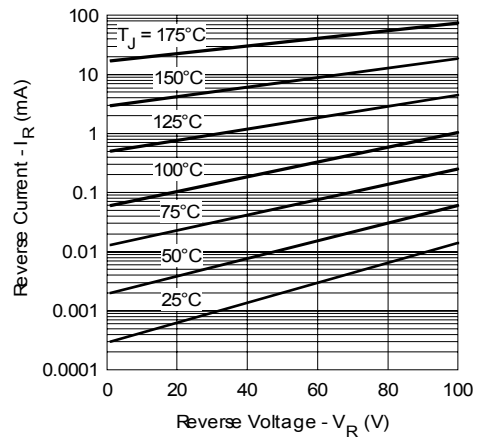

Fig. 2 - Typical Values Of Reverse Current Vs. Reverse Voltage (Per Leg)

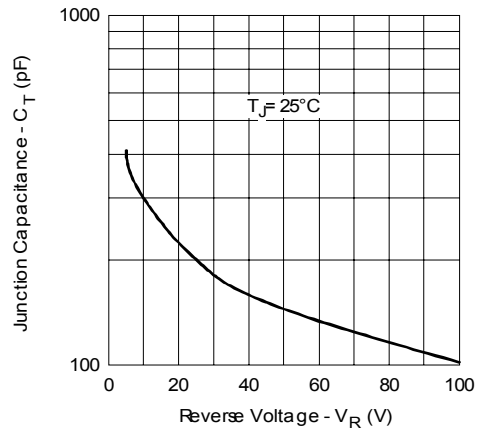

Fig. 3 - Typical Junction Capacitance Vs. Reverse Voltage (Per Leg)

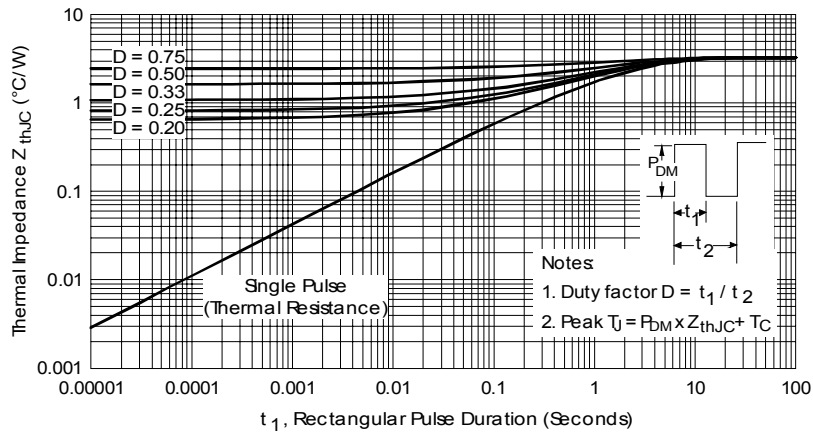

Fig. 4 - Max. Thermal Impedance Z_{thJC} Characteristics (Per Leg)

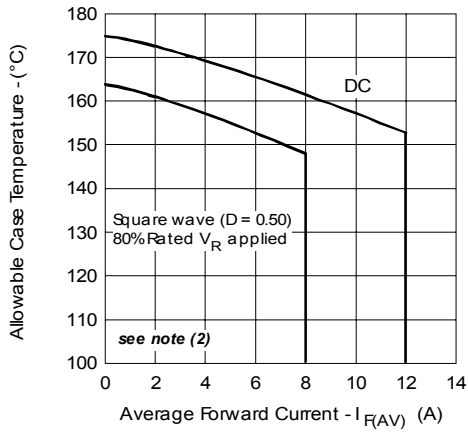

Fig. 5 - Max. Allowable Case Temperature Vs. Average Forward Current (Per Leg)

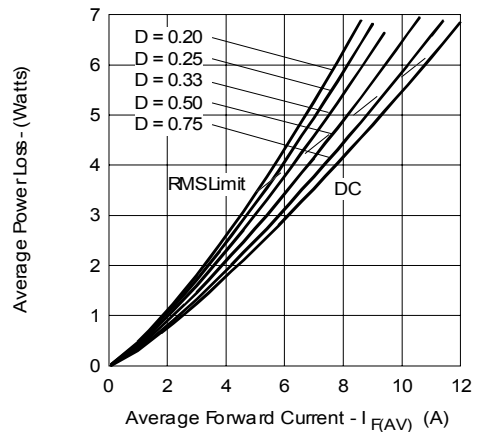

Fig. 6 - Forward Power Loss Characteristics (Per Leg)

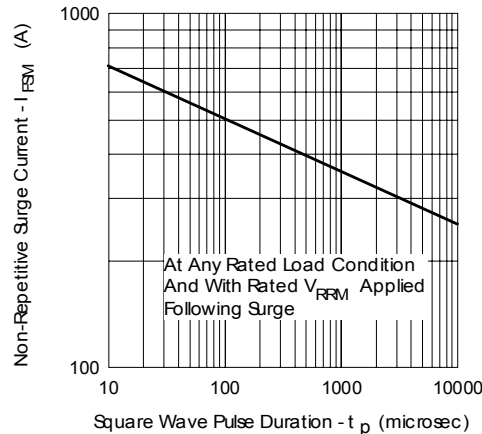

Fig. 7 - Max. Non-Repetitive Surge Current (Per Leg)

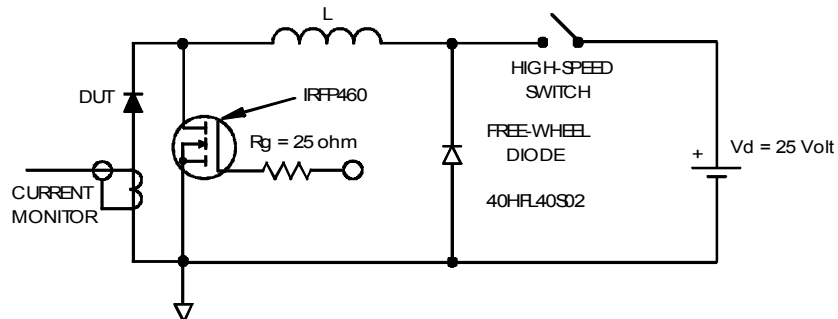
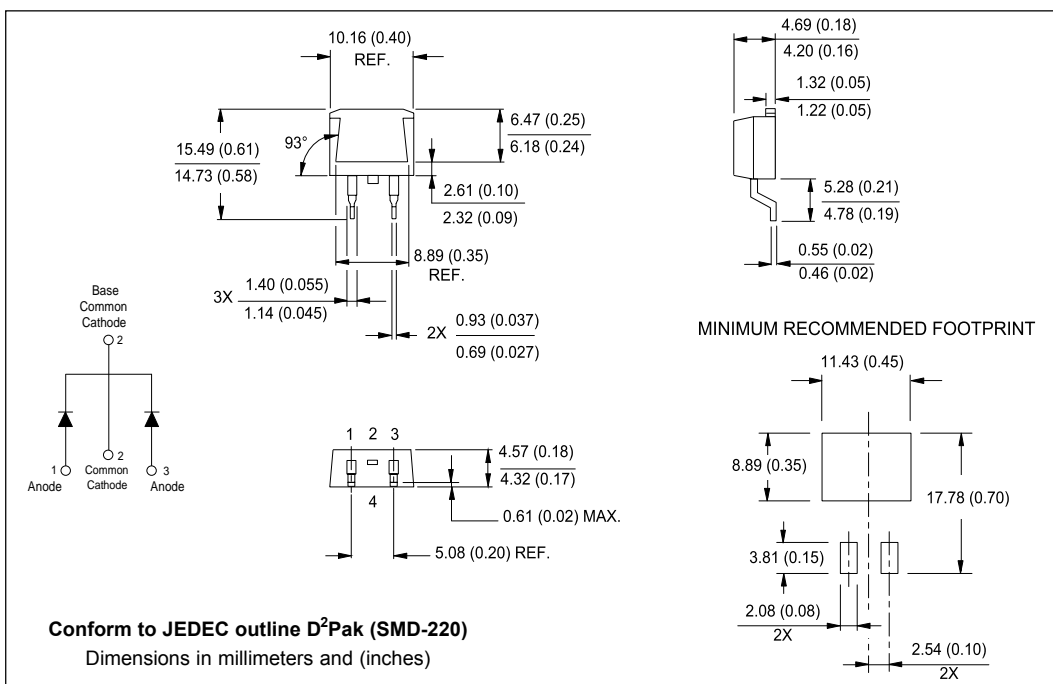
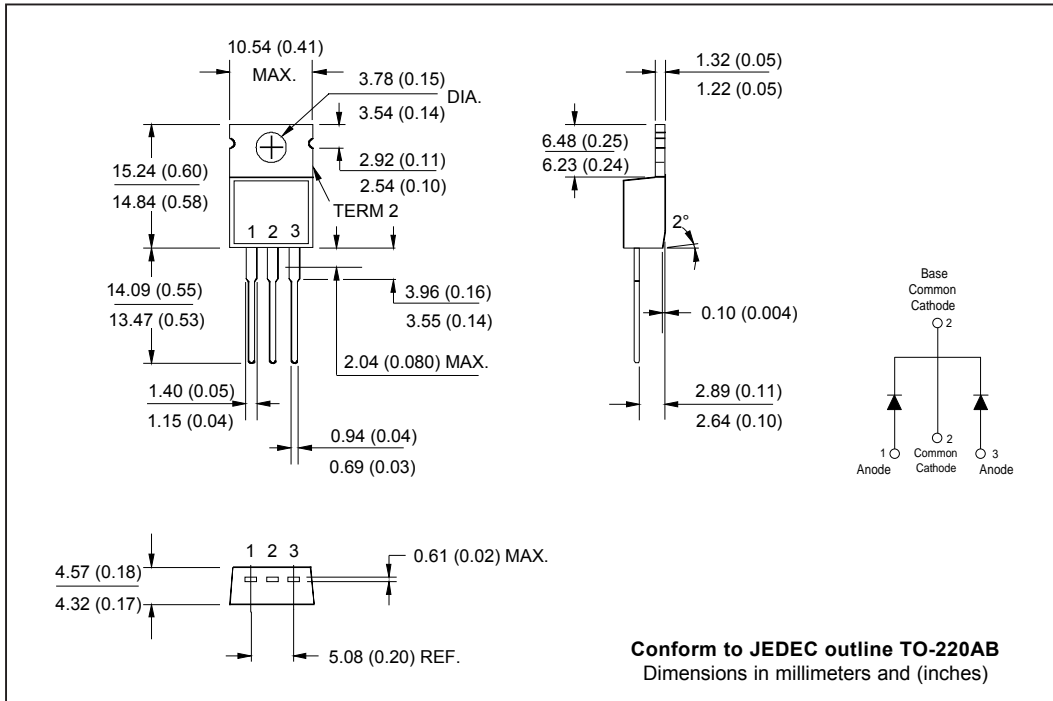

Fig. 8 - Unclamped Inductive Test Circuit

- (2) Formula used: $T_C = T_J - (P_d + P_{d_{REV}}) \times R_{thJC}$;
 $P_d = \text{Forward Power Loss} = I_{F(AV)} \times V_{FM} @ (I_{F(AV)} / D)$ (see Fig. 6);
 $P_{d_{REV}} = \text{Inverse Power Loss} = V_{R1} \times I_R (1 - D)$; $I_R @ V_{R1} = 10$ V

Outline Table



Outline Table

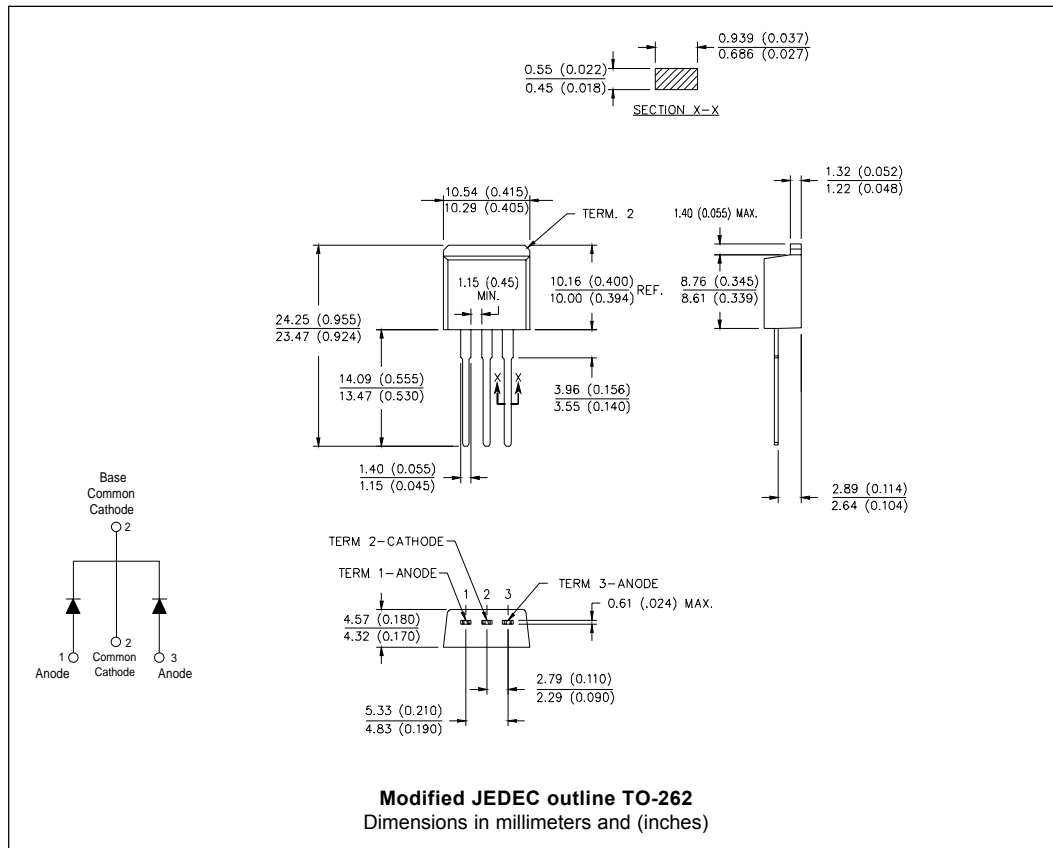

Marking Information

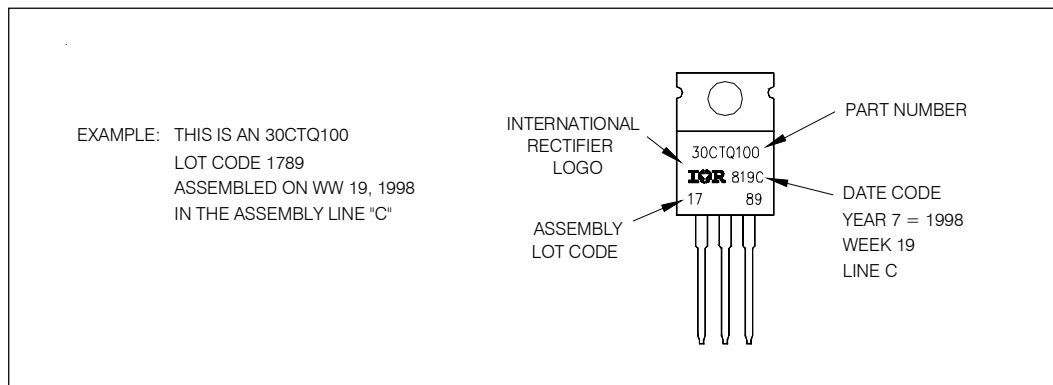

Tape & Reel Information

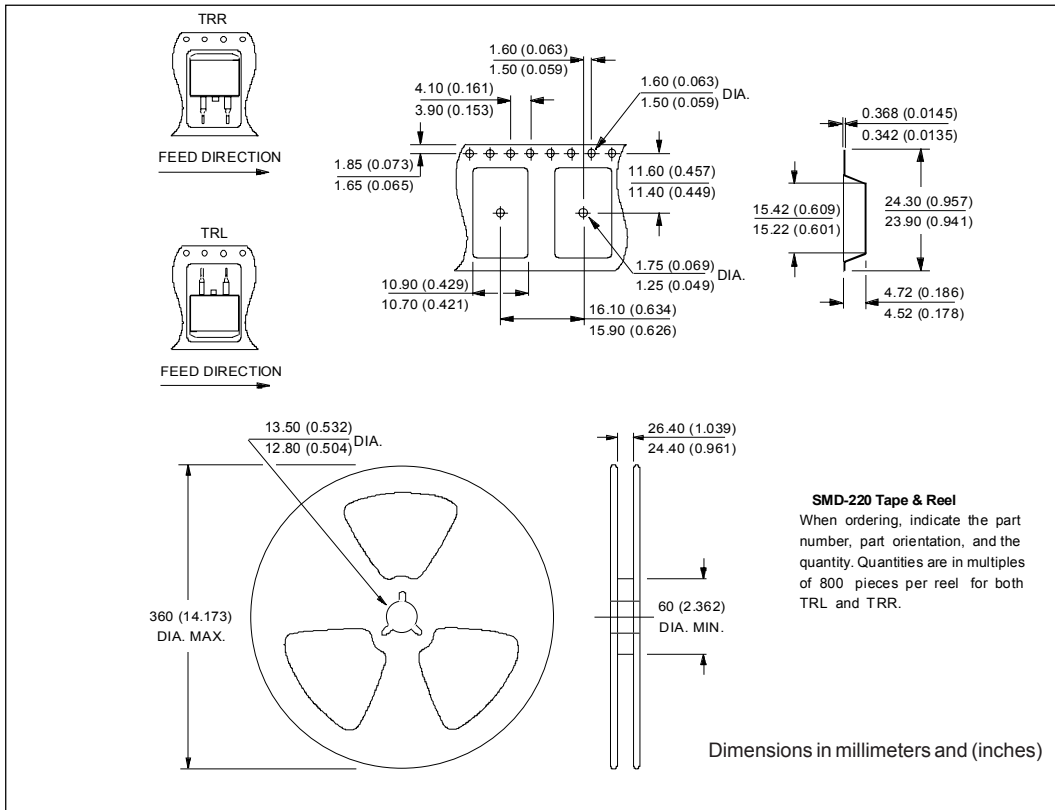

Ordering Information Table

Device Code	30	C	T	Q	100	-1
	1	2	3	4	5	6
1	- Essential Part Number					
2	- C = Common Cathode					
3	- T = TO-220					
4	- Q = Schottky Q Series					
5	- Voltage Rating					
6	- 1 = TO-262					
	S = D ² Pak					

080 = 80V
 100 = 100V

30CTQ..., 30CTQ...S, 30CTQ...-1

Bulletin PD-20606 rev. B 01/04

International
IOR Rectifier

Data and specifications subject to change without notice.
This product has been designed and qualified for Industrial Level.
Qualification Standards can be found on IR's Web site.

International
IOR Rectifier

IR WORLD HEADQUARTERS: 233 Kansas St., El Segundo, California 90245, USA Tel: (310) 252-7105
TAC Fax: (310) 252-7309
Visit us at www.irf.com for sales contact information. 01/04