

N-CHANNEL SILICON POWER MOS-FET

Features

- High speed switching
- Low on-resistance
- No secondary breakdown
- Low driving power
- Avalanche-proof

Applications

- Switching regulators
- UPS (Uninterruptible Power Supply)
- DC-DC converters

Maximum ratings and characteristic Absolute maximum ratings

(Tc=25°C unless otherwise specified)

Item	Symbol	Rating	Unit
Drain-source voltage	V _{DS}	400	V
Continuous drain current	I _D	±23	A
Pulsed drain current	I _{D(puls)}	±92	A
Gate-source voltage	V _{GS}	±30	V
Repetitive or non-repetitive	IAR *2	23	A
Maximum Avalanche Energy	E _{AV} *1	545	mJ
Max. power dissipation	P _D	295	W
Operating and storage temperature range	T _{ch} T _{stg}	+150 -55 to +150	°C

*1 L=1.89mH, V_{CC}=40V *2 T_{ch}=150°C

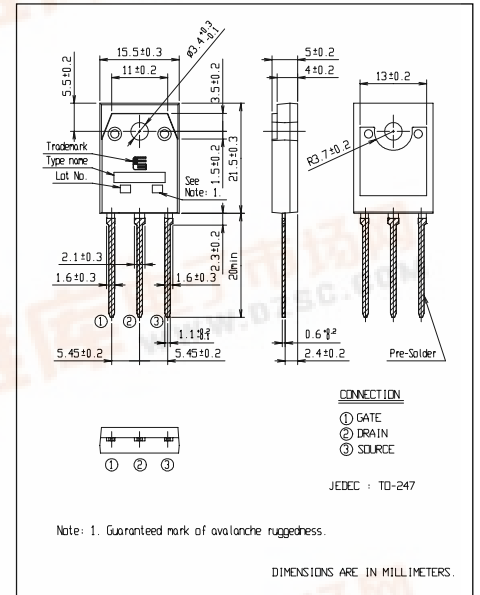

Equivalent circuit schematic

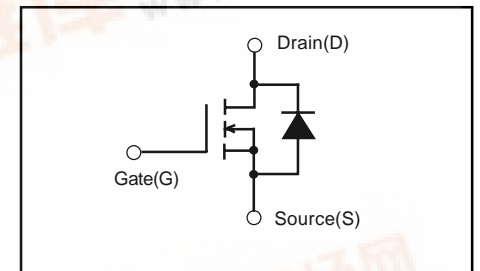

Electrical characteristics (Tc =25°C unless otherwise specified)

Item	Symbol	Test Conditions	Min.	Typ.	Max.	Units
Drain-source breakdown voltage	V _{(BR)DSS}	I _D =1mA V _{GS} =0V	400			V
Gate threshold voltage	V _{GS(th)}	I _D =1mA V _{DS} =V _{GS}	2.5	3.0	3.5	V
Zero gate voltage drain current	I _{DSS}	V _{DS} =400V V _{GS} =0V	T _{ch} =25°C	10	500	μA
			T _{ch} =125°C	0.2	1.0	mA
Gate-source leakage current	I _{GSS}	V _{GS} =±30V V _{DS} =0V		10	100	nA
Drain-source on-state resistance	R _{DS(on)}	I _D =11.5A V _{GS} =10V		0.16	0.2	Ω
Forward transconductance	g _{fs}	I _D =11.5A V _{DS} =25V	8.5	17		S
Input capacitance	C _{iss}	V _{DS} =25V		2650	3975	pF
Output capacitance	C _{oss}	V _{GS} =0V		500	750	pF
Reverse transfer capacitance	C _{rss}	f=1MHz		230	345	pF
Turn-on time t _{on}	td(on)	V _{CC} =300V I _D =23A		22	35	ns
	tr	V _{GS} =10V		105	160	
Turn-off time t _{off}	td(off)	R _{GS} =10Ω		225	340	ns
	tr			120	180	
Total gate charge	Q _G	V _{CC} =200V		137	210	nC
Gate-Source charge	Q _{GS}	I _D =23A		36	55	
Gate-Drain charge	Q _{GD}	V _{GS} =10V		48	75	
Avalanche capability	I _{AV}	L=1.89mH T _{ch} =25°C	23			A
Diode forward on-voltage	V _{SD}	I _F =2xI _{DR} V _{GS} =0V T _{ch} =25°C		1.15	1.73	V
Reverse recovery time	t _{rr}	I _F =I _{DR} V _{GS} =0V		450		ns
Reverse recovery charge	Q _{rr}	-di/dt=100A/μs T _{ch} =25°C		8.6		μC

Thermal characteristics

Item	Symbol	Test Conditions	Min.	Typ.	Max.	Units
Thermal resistance	R _{th(ch-c)}	channel to case			0.424	°C/W
	R _{th(ch-a)}	channel to ambient			50.0	°C/W



Characteristics

Allowable Power Dissipation
 $PD=f(T_c)$

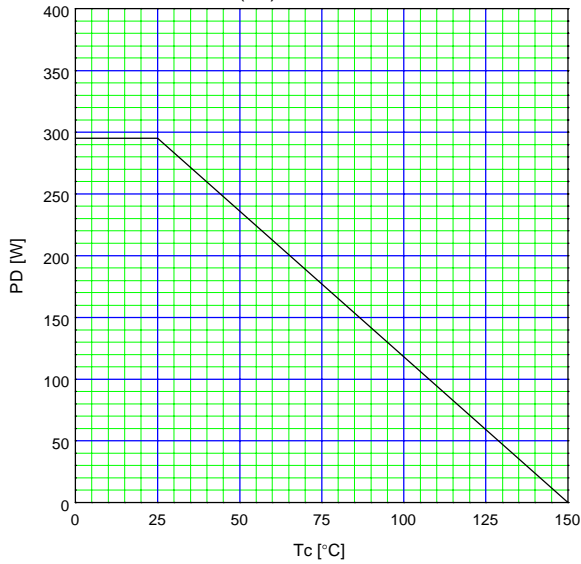

Safe operating area
 $ID=f(V_{DS}):$ Single Pulse, $T_c=25^\circ\text{C}$

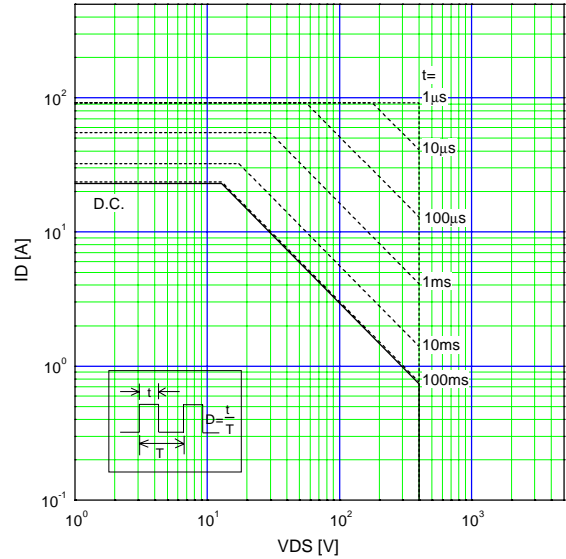

Typical Output Characteristics
 $ID=f(V_{DS}):$ 80 μs pulse test, $T_{ch}=25^\circ\text{C}$

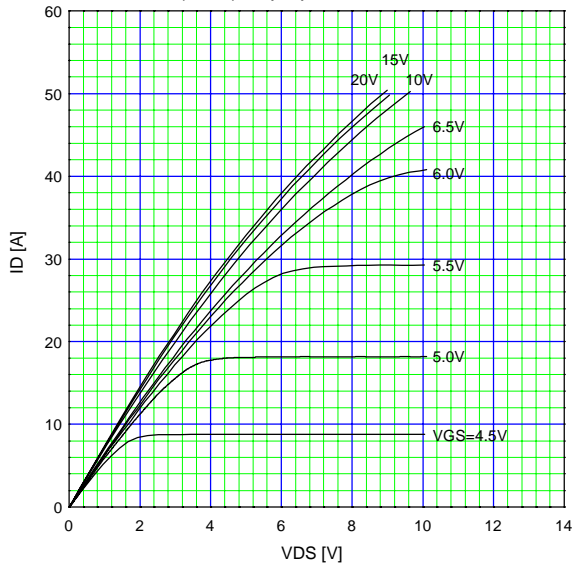

Typical Transfer Characteristic
 $ID=f(V_{GS}):$ 80 μs pulse test, $V_{DS}=25\text{V}$, $T_{ch}=25^\circ\text{C}$

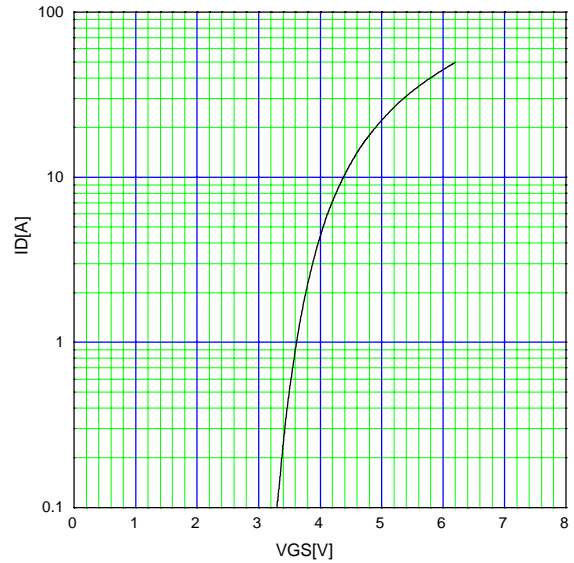

Typical Transconductance
 $g_{fs}=f(I_D):$ 80 μs pulse test, $V_{DS}=25\text{V}$, $T_{ch}=25^\circ\text{C}$

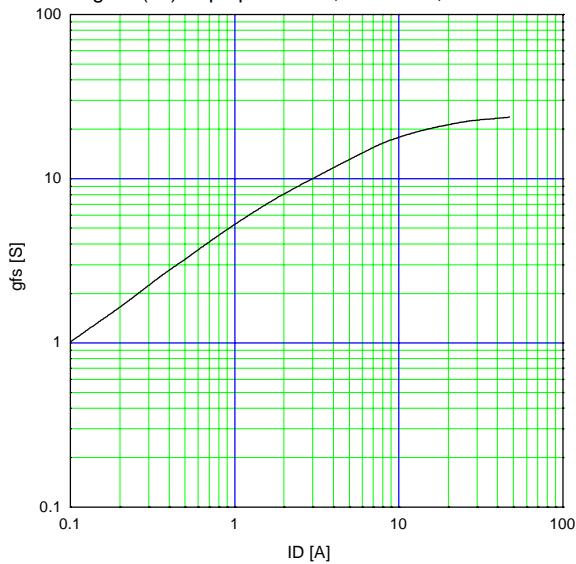

Typical Drain-Source on-state Resistance
 $R_{DS(on)}=f(I_D):$ 80 μs pulse test, $T_{ch}=25^\circ\text{C}$

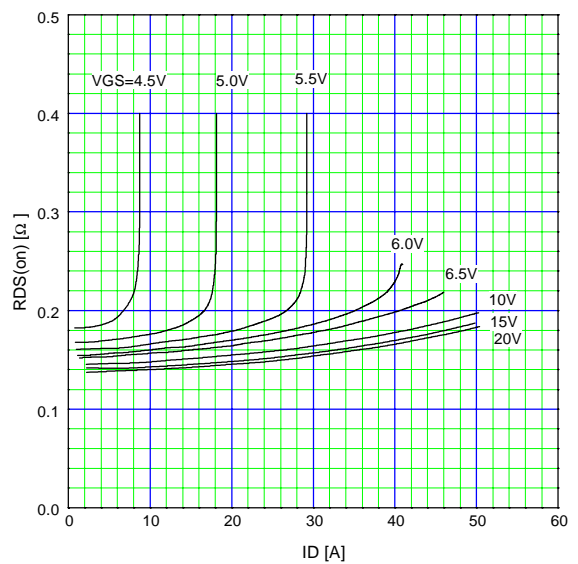

Drain-Source On-state Resistance
 $R_{DS(on)}=f(T_{ch}):I_D=11.5A, V_{GS}=10V$

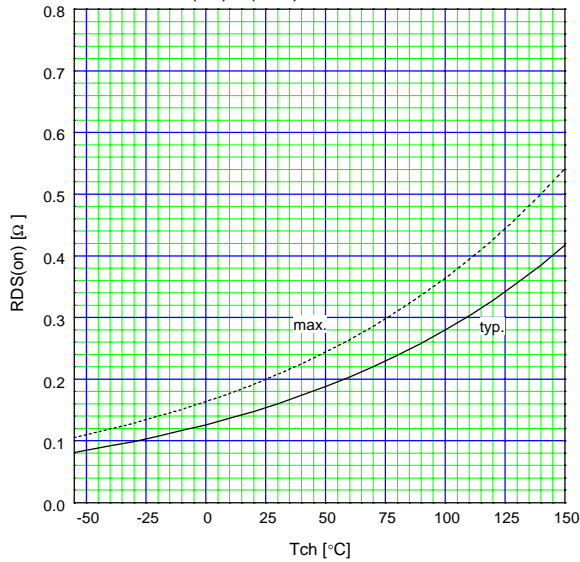

Gate Threshold Voltage vs. T_{ch}
 $V_{GS(th)}=f(T_{ch}):V_{DS}=V_{GS}, I_D=1mA$

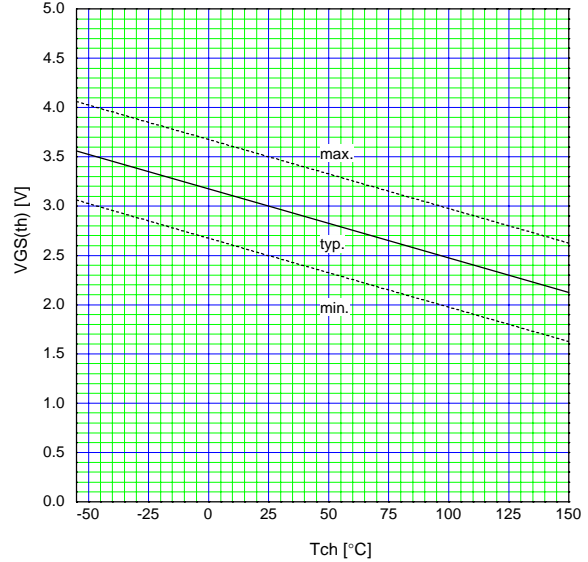

Typical Gate Charge Characteristics
 $V_{GS}=f(Q_g):I_D=23A, T_{ch}=25^{\circ}C$

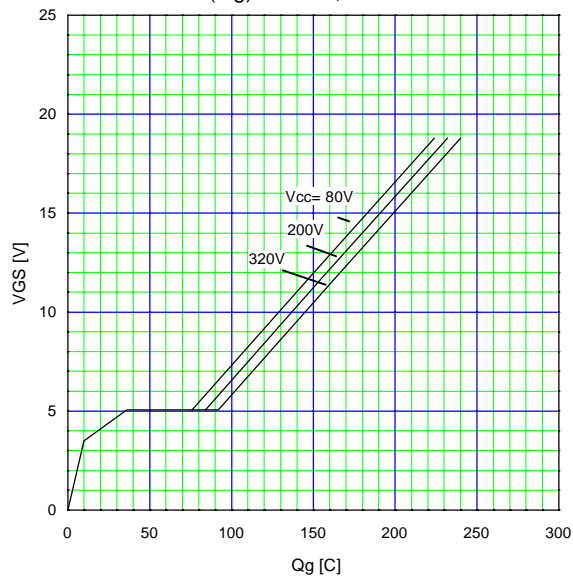

Typical Capacitance
 $C=f(V_{DS}):V_{GS}=0V, f=1MHz$

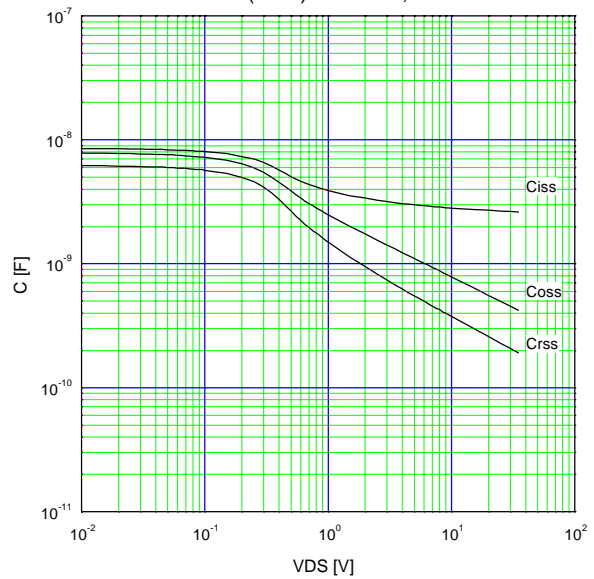

Typical Forward Characteristics of Reverse Diode
 $I_F=f(V_{SD}):80\mu s$ pulse test, $T_{ch}=25^{\circ}C$

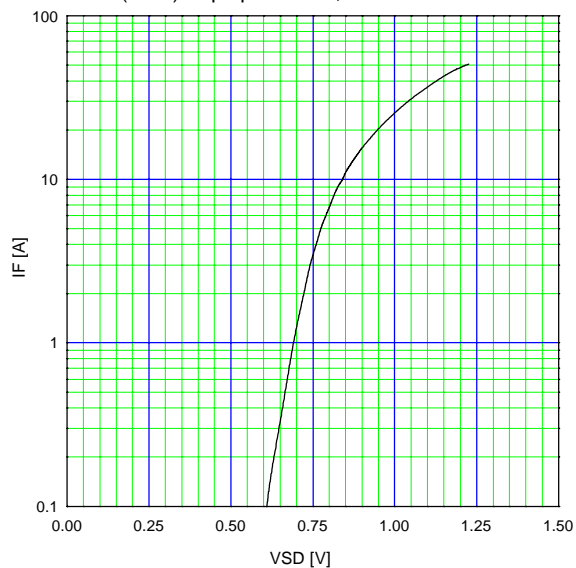

Typical Switching Characteristics vs. I_D
 $t=f(I_D):V_{CC}=300V, V_{GS}=10V, R_G=10\Omega$

