

# MUN5211T1 Series

Preferred Devices

## Bias Resistor Transistor

### NPN Silicon Surface Mount Transistor with Monolithic Bias Resistor Network

This new series of digital transistors is designed to replace a single device and its external resistor bias network. The BRT (Bias Resistor Transistor) contains a single transistor with a monolithic bias network consisting of two resistors; a series base resistor and a base-emitter resistor. The BRT eliminates these individual components by integrating them into a single device. The use of a BRT can reduce both system cost and board space. The device is housed in the SC-70/SOT-323 package which is designed for low power surface mount applications.

- Simplifies Circuit Design
- Reduces Board Space
- Reduces Component Count
- The SC-70/SOT-323 package can be soldered using wave or reflow. The modified gull-winged leads absorb thermal stress during soldering eliminating the possibility of damage to the die.
- Available in 8 mm embossed tape and reel. Use the Device Number to order the 7 inch/3000 unit reel.
- Pb-Free Packages are Available

#### MAXIMUM RATINGS ( $T_A = 25^\circ\text{C}$ unless otherwise noted)

Rating	Symbol	Value	Unit
Collector-Base Voltage	$V_{CBO}$	50	Vdc
Collector-Emitter Voltage	$V_{CEO}$	50	Vdc
Collector Current	$I_C$	100	mAdc

#### THERMAL CHARACTERISTICS

Characteristic	Symbol	Max	Unit
Total Device Dissipation $T_A = 25^\circ\text{C}$ Derate above $25^\circ\text{C}$	$P_D$	202 (Note 1) 310 (Note 2) 1.6 (Note 1) 2.5 (Note 2)	mW mW/ $^\circ\text{C}$
Thermal Resistance - Junction-to-Ambient	$R_{\theta JA}$	618 (Note 1) 403 (Note 2)	$^\circ\text{C/W}$
Thermal Resistance - Junction-to-Lead	$R_{\theta JL}$	280 (Note 1) 332 (Note 2)	$^\circ\text{C/W}$
Junction and Storage Temperature Range	$T_J, T_{stg}$	-55 to +150	$^\circ\text{C}$

Maximum ratings are those values beyond which device damage can occur. Maximum ratings applied to the device are individual stress limit values (not normal operating conditions) and are not valid simultaneously. If these limits are exceeded, device functional operation is not implied, damage may occur and reliability may be affected.

1. FR-4 @ Minimum Pad.
2. FR-4 @ 1.0 x 1.0 inch Pad.



ON Semiconductor®

<http://onsemi.com>

### NPN SILICON BIAS RESISTOR TRANSISTORS

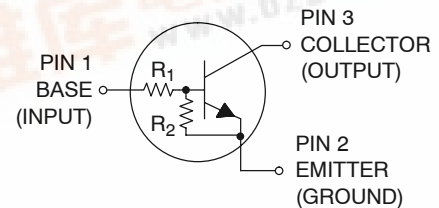

#### MARKING DIAGRAM



SC-70/SOT-323  
CASE 419  
STYLE 3

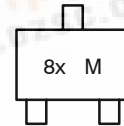

- 8x = Specific Device Code
- x = (See Marking Table)
- M = Date Code

#### ORDERING INFORMATION

See detailed ordering and shipping information in the package dimensions section on page 2 of this data sheet.

#### DEVICE MARKING INFORMATION

See specific marking information in the device marking table on page 2 of this data sheet.

Preferred devices are recommended choices for future use and best overall value.



## MUN5211T1 Series

### DEVICE MARKING AND RESISTOR VALUES

Device	Package	Marking	R1 (K)	R2 (K)	Shipping <sup>†</sup>
MUN5211T1	SC-70/SOT-323	8A	10	10	3000 / Tape & Reel
MUN5211T1G	SC-70/SOT-323 (Pb-Free)	8A	10	10	3000 / Tape & Reel
MUN5212T1	SC-70/SOT-323	8B	22	22	3000 / Tape & Reel
MUN5212T1G	SC-70/SOT-323 (Pb-Free)	8B	22	22	3000 / Tape & Reel
MUN5213T1	SC-70/SOT-323	8C	47	47	3000 / Tape & Reel
MUN5213T1G	SC-70/SOT-323 (Pb-Free)	8C	47	47	3000 / Tape & Reel
MUN5214T1	SC-70/SOT-323	8D	10	47	3000 / Tape & Reel
MUN5214T1G	SC-70/SOT-323 (Pb-Free)	8D	10	47	3000 / Tape & Reel
MUN5215T1 (Note 3)	SC-70/SOT-323	8E	10	∞	3000 / Tape & Reel
MUN5215T1G (Note 3)	SC-70/SOT-323 (Pb-Free)	8E	10	∞	3000 / Tape & Reel
MUN5216T1 (Note 3)	SC-70/SOT-323	8F	4.7	∞	3000 / Tape & Reel
MUN5216T1G (Note 3)	SC-70/SOT-323 (Pb-Free)	8F	4.7	∞	3000 / Tape & Reel
MUN5230T1 (Note 3)	SC-70/SOT-323	8G	1.0	1.0	3000 / Tape & Reel
MUN5231T1 (Note 3)	SC-70/SOT-323	8H	2.2	2.2	3000 / Tape & Reel
MUN5231T1G (Note 3)	SC-70/SOT-323 (Pb-Free)	8H	2.2	2.2	3000 / Tape & Reel
MUN5232T1 (Note 3)	SC-70/SOT-323	8J	4.7	4.7	3000 / Tape & Reel
MUN5232T1G (Note 3)	SC-70/SOT-323 (Pb-Free)	8J	4.7	4.7	3000 / Tape & Reel
MUN5233T1 (Note 3)	SC-70/SOT-323	8K	4.7	47	3000 / Tape & Reel
MUN5233T1G (Note 3)	SC-70/SOT-323 (Pb-Free)	8K	4.7	47	3000 / Tape & Reel
MUN5234T1 (Note 3)	SC-70/SOT-323	8L	22	47	3000 / Tape & Reel
MUN5235T1 (Note 3)	SC-70/SOT-323	8M	2.2	47	3000 / Tape & Reel
MUN5235T1G (Note 3)	SC-70/SOT-323 (Pb-Free)	8M	2.2	47	3000 / Tape & Reel
MUN5236T1 (Note 3)	SC-70/SOT-323	8N	100	100	3000 / Tape & Reel
MUN5237T1 (Note 3)	SC-70/SOT-323	8P	47	22	3000 / Tape & Reel

<sup>†</sup>For information on tape and reel specifications, including part orientation and tape sizes, please refer to our Tape and Reel Packaging Specifications Brochure, BRD8011/D.

3. New devices. Updated curves to follow in subsequent data sheets.



## MUN5211T1 Series

### ELECTRICAL CHARACTERISTICS ( $T_A = 25^\circ\text{C}$ unless otherwise noted) (Continued)

Characteristic	Symbol	Min	Typ	Max	Unit
<b>ON CHARACTERISTICS</b> (Note 5) (Continued)					
Output Voltage (off) ( $V_{CC} = 5.0\text{ V}$ , $V_B = 0.5\text{ V}$ , $R_L = 1.0\text{ k}\Omega$ ) ( $V_{CC} = 5.0\text{ V}$ , $V_B = 0.050\text{ V}$ , $R_L = 1.0\text{ k}\Omega$ ) ( $V_{CC} = 5.0\text{ V}$ , $V_B = 0.25\text{ V}$ , $R_L = 1.0\text{ k}\Omega$ )	$V_{OH}$	4.9	–	–	Vdc
Input Resistor	$R_1$	7.0	10	13	$\text{k}\Omega$
	MUN5211T1	15.4	22	28.6	
	MUN5212T1	32.9	47	61.1	
	MUN5213T1	7.0	10	13	
	MUN5214T1	7.0	10	13	
	MUN5215T1	3.3	4.7	6.1	
	MUN5216T1	0.7	1.0	1.3	
	MUN5230T1	1.5	2.2	2.9	
	MUN5231T1	3.3	4.7	6.1	
	MUN5232T1	3.3	4.7	6.1	
	MUN5233T1	15.4	22	28.6	
	MUN5234T1	1.54	2.2	2.86	
	MUN5235T1	70	100	130	
	MUN5236T1	32.9	47	61.1	
	MUN5237T1				
Resistor Ratio	$R_1/R_2$	0.8	1.0	1.2	
	MUN5211T1/MUN5212T1/MUN5213T1/ MUN5236T1	0.17	0.21	0.25	
	MUN5214T1	–	–	–	
	MUN5215T1/MUN5216T1	0.8	1.0	1.2	
	MUN5230T1/MUN5231T1/MUN5232T1	0.055	0.1	0.185	
	MUN5233T1	0.38	0.47	0.56	
	MUN5234T1	0.038	0.047	0.056	
	MUN5235T1	1.7	2.1	2.6	
	MUN5237T1				

5. Pulse Test: Pulse Width < 300  $\mu\text{s}$ , Duty Cycle < 2.0%

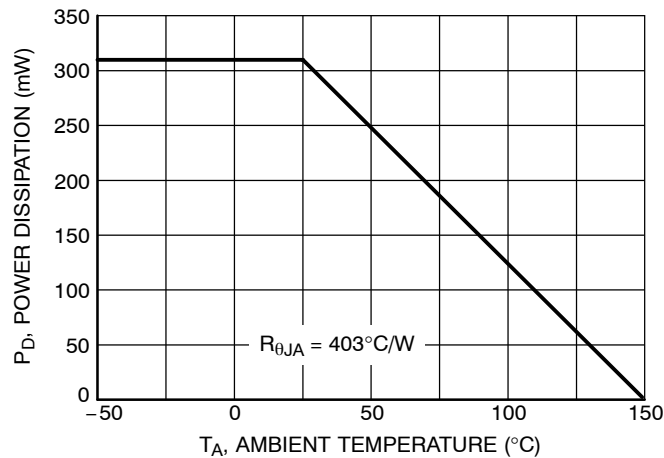

**Figure 1. Derating Curve**

# MUN5211T1 Series

## TYPICAL ELECTRICAL CHARACTERISTICS - MUN5211T1

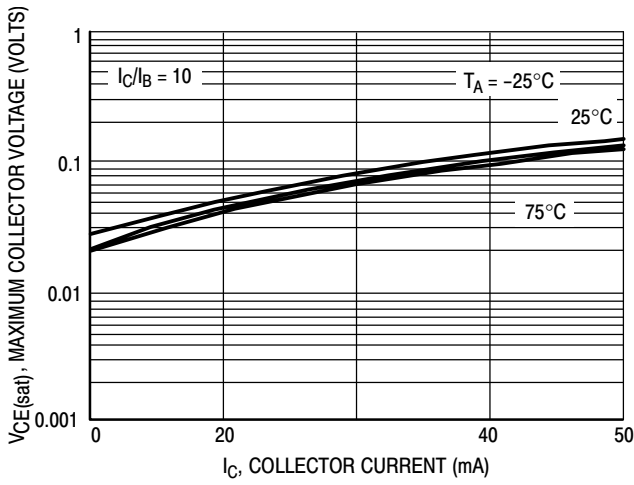

Figure 2.  $V_{CE(sat)}$  versus  $I_C$

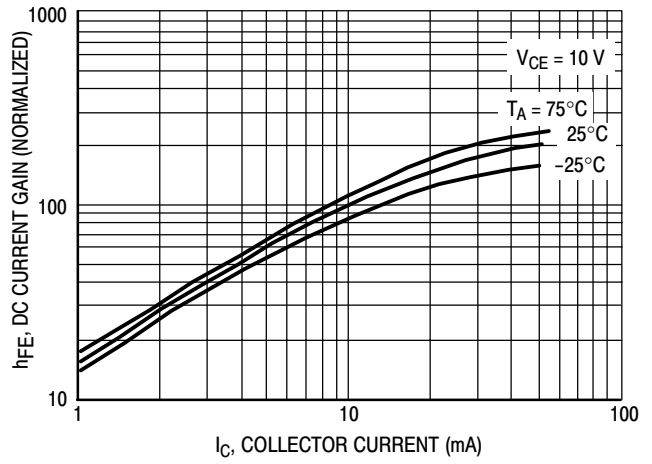

Figure 3. DC Current Gain

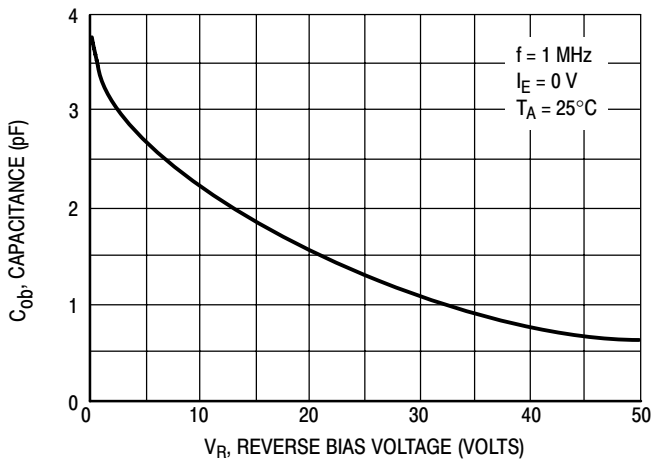

Figure 4. Output Capacitance

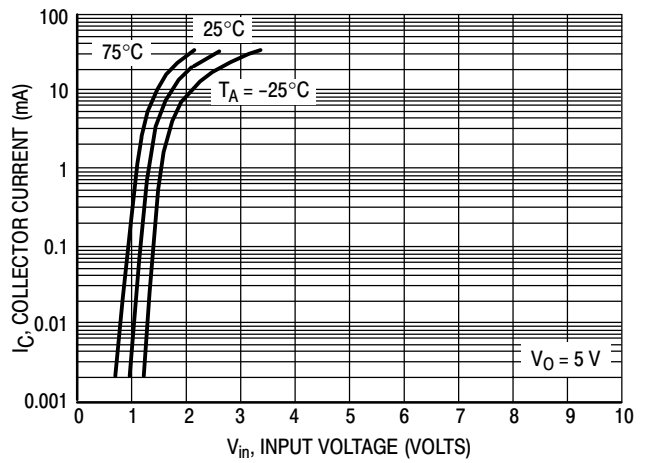

Figure 5. Output Current versus Input Voltage

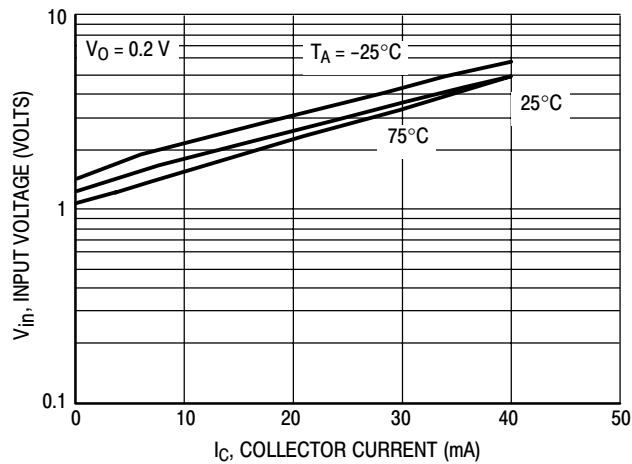

Figure 6. Input Voltage versus Output Current

# MUN5211T1 Series

## TYPICAL ELECTRICAL CHARACTERISTICS - MUN5212T1

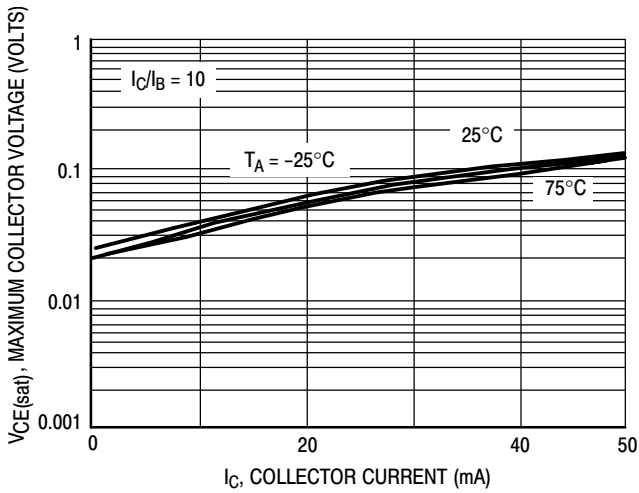

Figure 7.  $V_{CE(sat)}$  versus  $I_C$

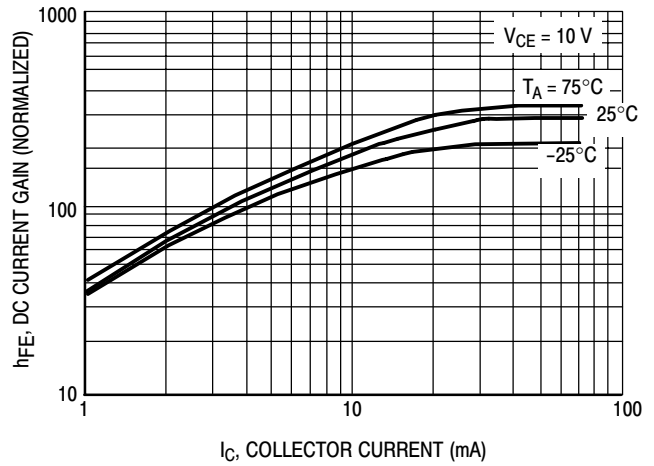

Figure 8. DC Current Gain

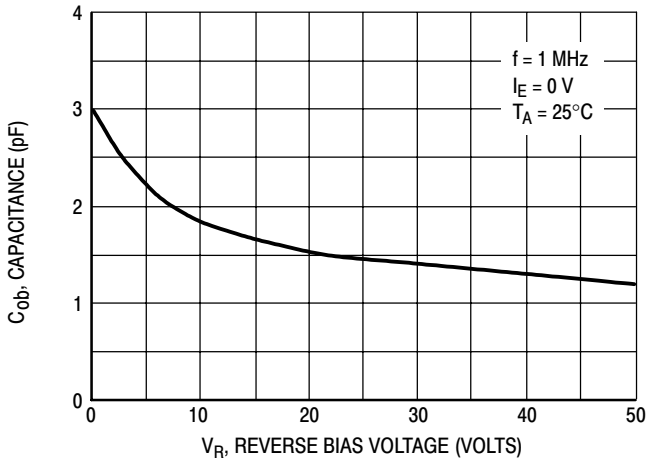

Figure 9. Output Capacitance

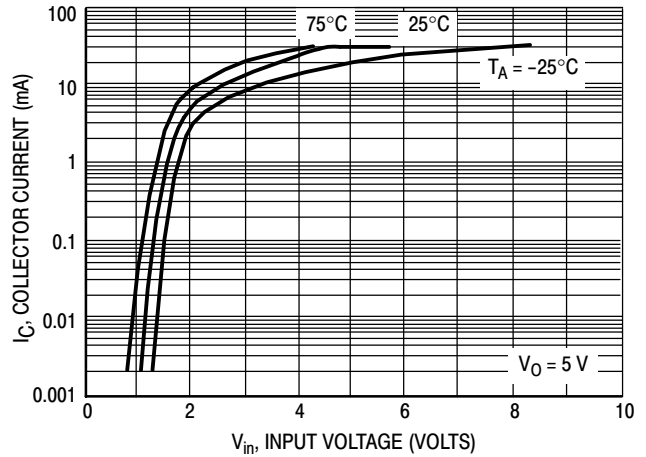

Figure 10. Output Current versus Input Voltage

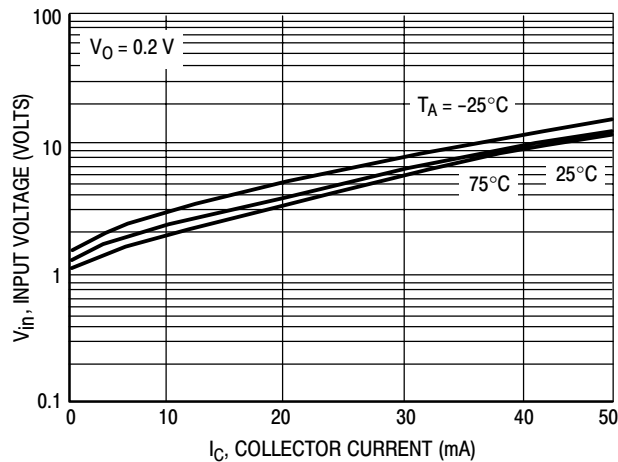

Figure 11. Input Voltage versus Output Current

# MUN5211T1 Series

## TYPICAL ELECTRICAL CHARACTERISTICS – MUN5213T1

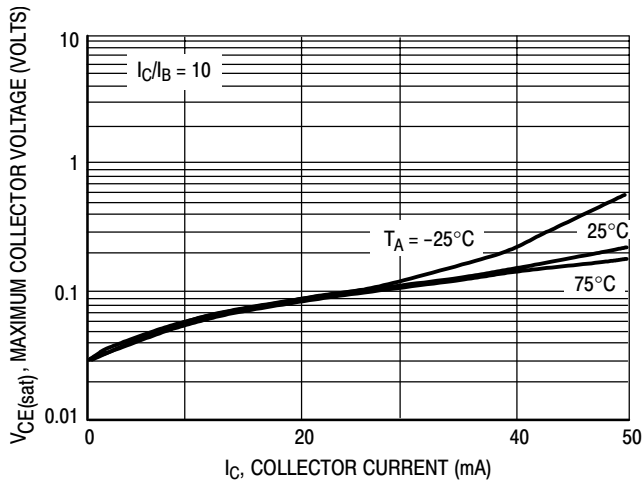

Figure 12.  $V_{CE(sat)}$  versus  $I_C$

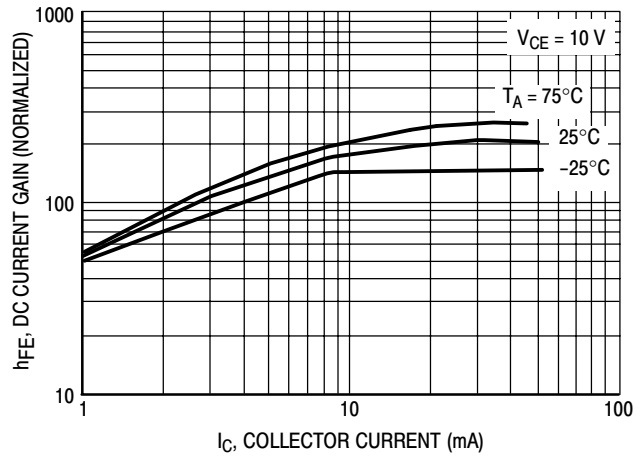

Figure 13. DC Current Gain

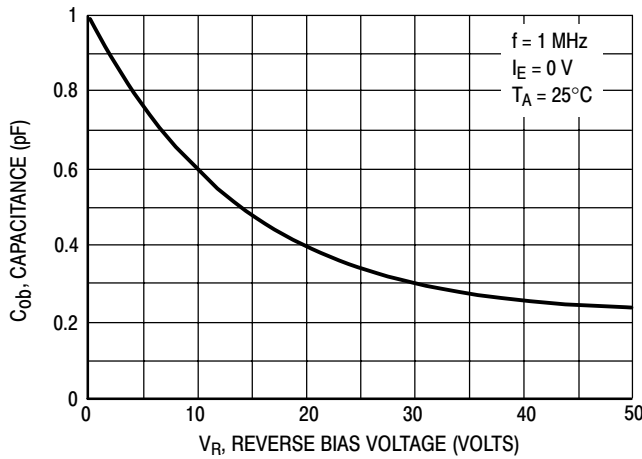

Figure 14. Output Capacitance

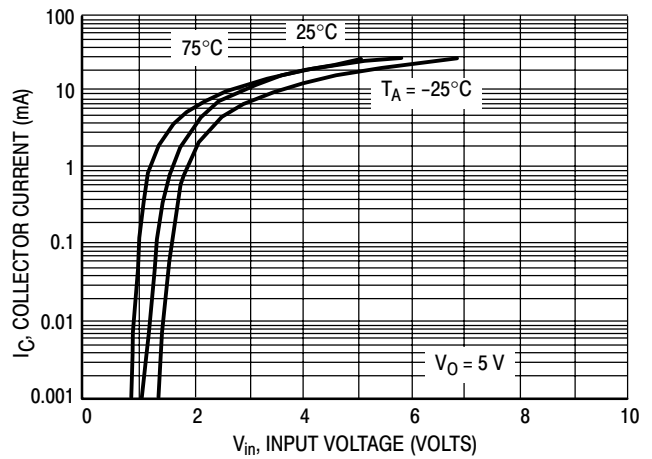

Figure 15. Output Current versus Input Voltage

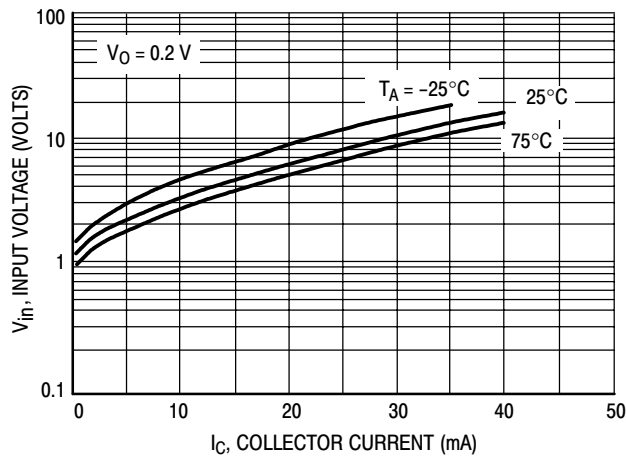

Figure 16. Input Voltage versus Output Current

# MUN5211T1 Series

## TYPICAL ELECTRICAL CHARACTERISTICS – MUN5214T1

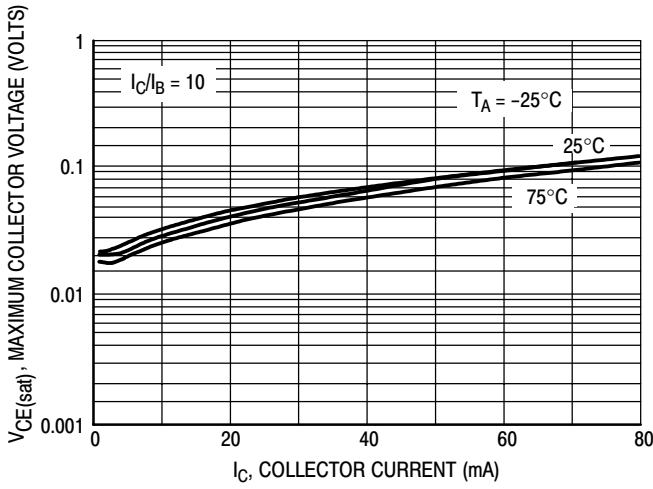

Figure 17.  $V_{CE(sat)}$  versus  $I_C$

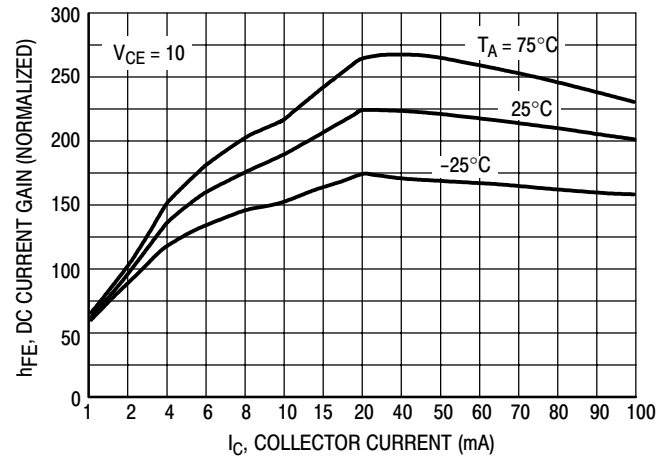

Figure 18. DC Current Gain

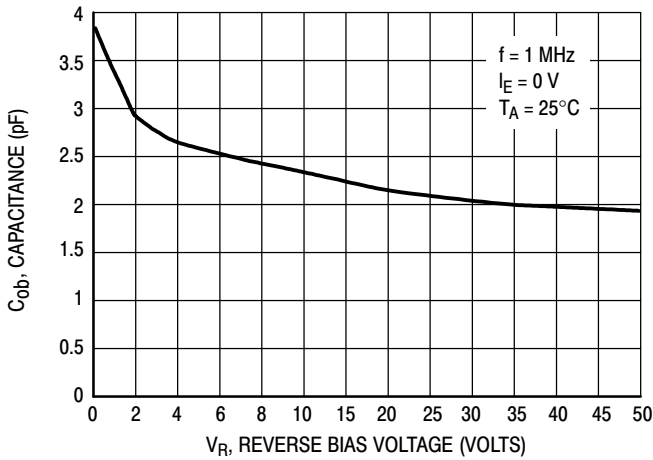

Figure 19. Output Capacitance

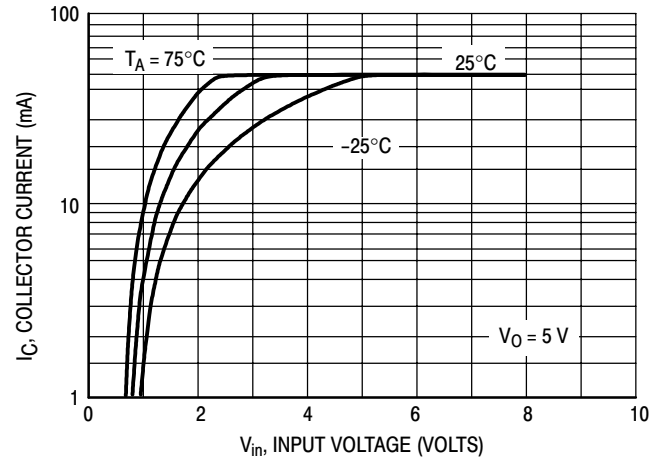

Figure 20. Output Current versus Input Voltage

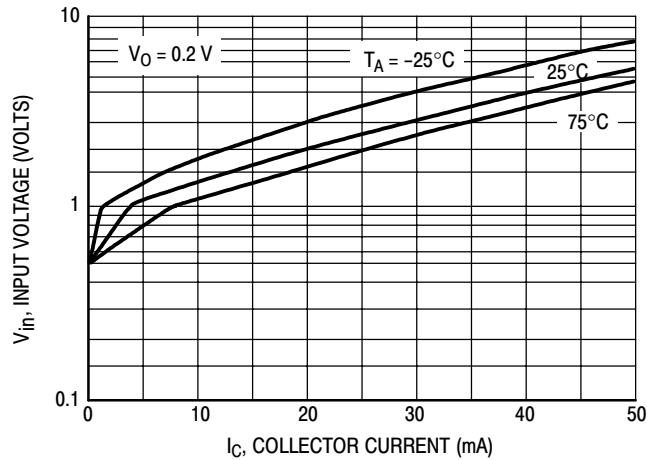

Figure 21. Input Voltage versus Output Current



# MUN5211T1 Series

## TYPICAL APPLICATIONS FOR NPN BRTs

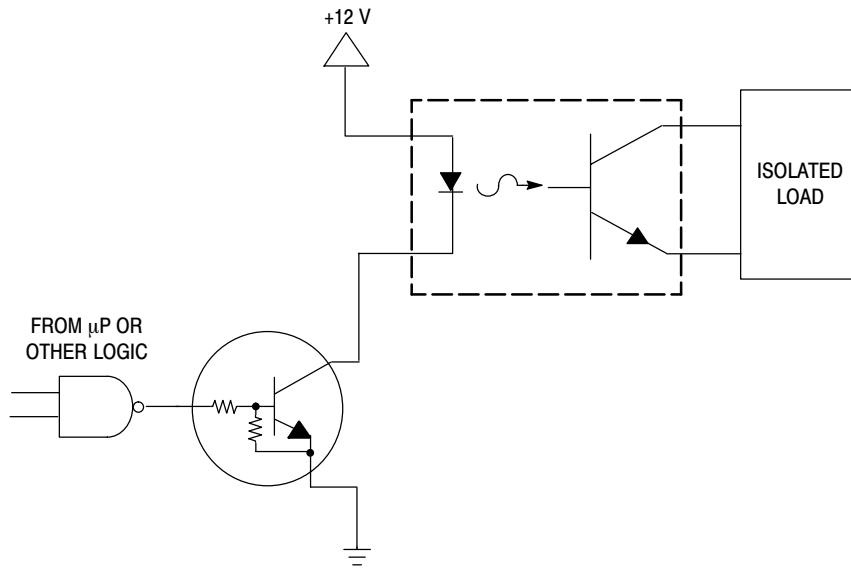

Figure 22. Level Shifter: Connects 12 or 24 Volt Circuits to Logic

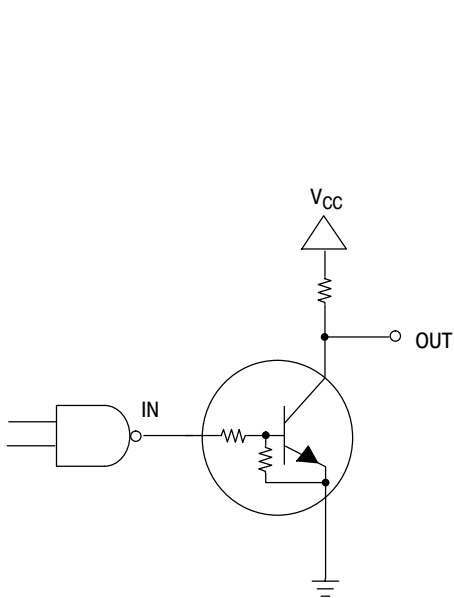

Figure 23. Open Collector Inverter: Inverts the Input Signal

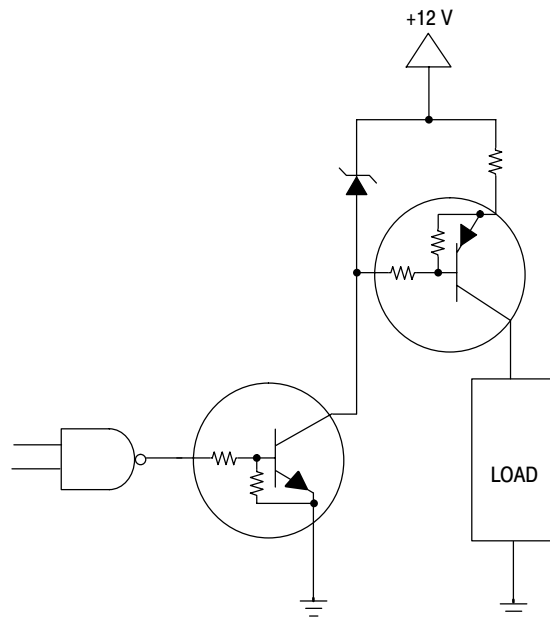
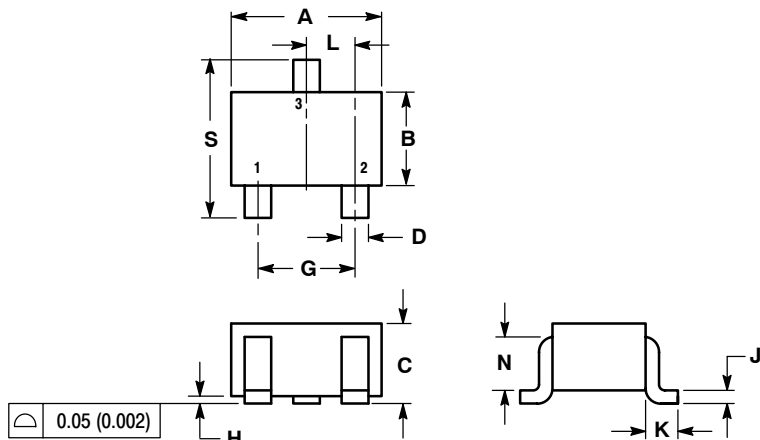

Figure 24. Inexpensive, Unregulated Current Source

# MUN5211T1 Series

## PACKAGE DIMENSIONS

SC-70/SOT-323  
CASE 419-04  
ISSUE L



- NOTES:  
1. DIMENSIONING AND TOLERANCING PER ANSI Y14.5M, 1982.  
2. CONTROLLING DIMENSION: INCH.

DIM	INCHES		MILLIMETERS	
	MIN	MAX	MIN	MAX
A	0.071	0.087	1.80	2.20
B	0.045	0.053	1.15	1.35
C	0.032	0.040	0.80	1.00
D	0.012	0.016	0.30	0.40
G	0.047	0.055	1.20	1.40
H	0.000	0.004	0.00	0.10
J	0.004	0.010	0.10	0.25
K	0.017 REF		0.425 REF	
L	0.026 BSC		0.650 BSC	
N	0.028 REF		0.700 REF	
S	0.079	0.095	2.00	2.40

- STYLE 3:  
PIN 1. BASE  
2. EMITTER  
3. COLLECTOR

### SOLDERING FOOTPRINT\*

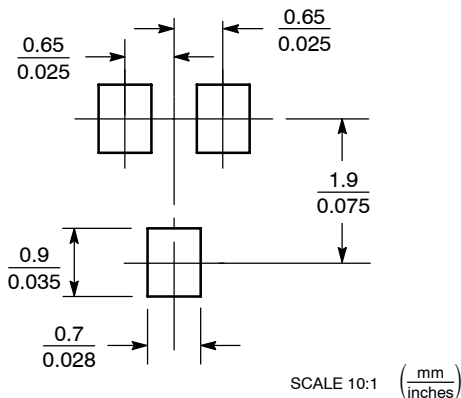

\*For additional information on our Pb-Free strategy and soldering details, please download the ON Semiconductor Soldering and Mounting Techniques Reference Manual, SOLDERRM/D.

ON Semiconductor and are registered trademarks of Semiconductor Components Industries, LLC (SCILLC). SCILLC reserves the right to make changes without further notice to any products herein. SCILLC makes no warranty, representation or guarantee regarding the suitability of its products for any particular purpose, nor does SCILLC assume any liability arising out of the application or use of any product or circuit, and specifically disclaims any and all liability, including without limitation special, consequential or incidental damages. "Typical" parameters which may be provided in SCILLC data sheets and/or specifications can and do vary in different applications and actual performance may vary over time. All operating parameters, including "Typicals" must be validated for each customer application by customer's technical experts. SCILLC does not convey any license under its patent rights nor the rights of others. SCILLC products are not designed, intended, or authorized for use as components in systems intended for surgical implant into the body, or other applications intended to support or sustain life, or for any other application in which the failure of the SCILLC product could create a situation where personal injury or death may occur. Should Buyer purchase or use SCILLC products for any such unintended or unauthorized application, Buyer shall indemnify and hold SCILLC and its officers, employees, subsidiaries, affiliates, and distributors harmless against all claims, costs, damages, and expenses, and reasonable attorney fees arising out of, directly or indirectly, any claim of personal injury or death associated with such unintended or unauthorized use, even if such claim alleges that SCILLC was negligent regarding the design or manufacture of the part. SCILLC is an Equal Opportunity/Affirmative Action Employer. This literature is subject to all applicable copyright laws and is not for resale in any manner.

### PUBLICATION ORDERING INFORMATION

#### LITERATURE FULFILLMENT:

Literature Distribution Center for ON Semiconductor  
P.O. Box 61312, Phoenix, Arizona 85082-1312 USA  
Phone: 480-829-7710 or 800-344-3860 Toll Free USA/Canada  
Fax: 480-829-7709 or 800-344-3867 Toll Free USA/Canada  
Email: orderlit@onsemi.com

N. American Technical Support: 800-282-9855 Toll Free  
USA/Canada

Japan: ON Semiconductor, Japan Customer Focus Center  
2-9-1 Kamimeguro, Meguro-ku, Tokyo, Japan 153-0051  
Phone: 81-3-5773-3850

ON Semiconductor Website: <http://onsemi.com>

Order Literature: <http://www.onsemi.com/litorder>

For additional information, please contact your local Sales Representative.