



JIANGSU CHANGJIANG ELECTRONICS TECHNOLOGY CO., LTD

TO-126 Plastic-Encapsulate Transistors

3CA8772 TRANSISTOR (PNP)

FEATURES

Power dissipation

$$P_{CM} : 1.25 \text{ W (} T_{amb}=25 \text{)}$$

Collector current

$$I_{CM} : -3 \text{ A}$$

Collector-base voltage

$$V_{(BR)CBO} : -40 \text{ V}$$

Operating and storage junction temperature range

$$T_J, T_{stg}: -55 \text{ to } +150$$

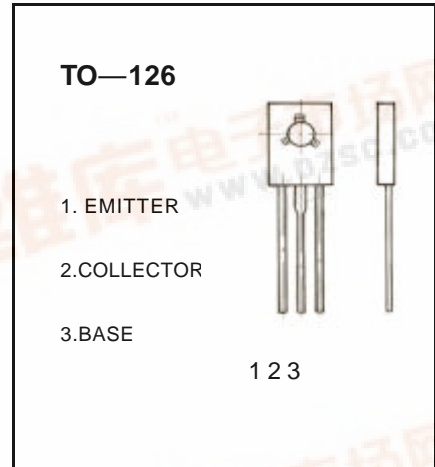

ELECTRICAL CHARACTERISTICS ($T_{amb}=25$ unless otherwise specified)

Parameter	Symbol	Test conditions	MIN	TYP	MAX	UNIT
Collector-base breakdown voltage	$V_{(BR)CBO}$	$I_C=-100 \mu A, I_E=0$	-40			V
Collector-emitter breakdown voltage	$V_{(BR)CEO}$	$I_C=-10 \text{ mA}, I_B=0$	-30			V
Emitter-base breakdown voltage	$V_{(BR)EBO}$	$I_E=-100 \mu A, I_C=0$	-6			V
Collector cut-off current	I_{CBO}	$V_{CB}=-40 \text{ V}, I_E=0$			-10	μA
Collector cut-off current	I_{CEO}	$V_{CE}=-30 \text{ V}, I_B=0$			-10	μA
Emitter cut-off current	I_{EBO}	$V_{EB}=-6 \text{ V}, I_C=0$			-10	μA
DC current gain	h_{FE}	$V_{CE}=-2 \text{ V}, I_C=-1 \text{ A}$	60		400	
Collector-emitter saturation voltage	$V_{CE(sat)}$	$I_C=-2 \text{ A}, I_B=-0.2 \text{ A}$			-0.5	V
Transition frequency	f_T	$V_{CE}=-5 \text{ V}, I_C=-0.1 \text{ A}$ $f = 10 \text{ MHz}$	50			MHz

CLASSIFICATION OF $h_{FE(1)}$

Rank	R	O	Y	GR
Range	60-120	100-200	160-320	200-400



Typical Characteristics

3CA8772

TOTAL POWER DISSIPATION vs. AMBIENT TEMPERATURE

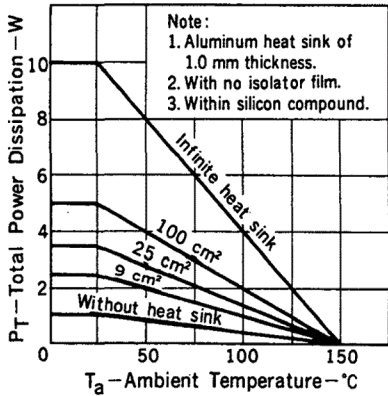

DERATING CURVES FOR ALL TYPES

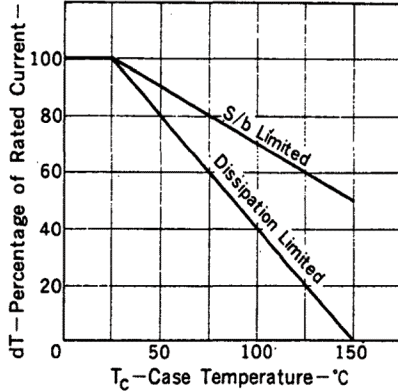

THERMAL RESISTANCE vs. PULSE WIDTH

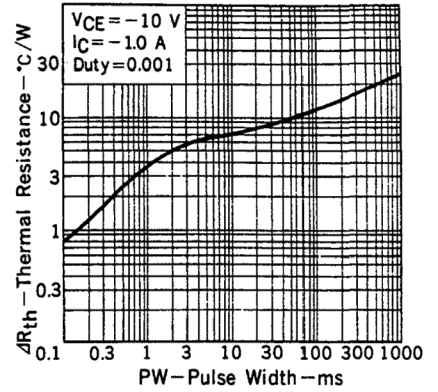

SAFE OPERATING AREAS

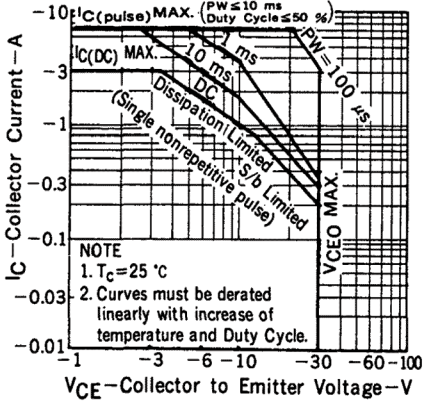

COLLECTOR CURRENT vs. COLLECTOR TO EMITTER VOLTAGE

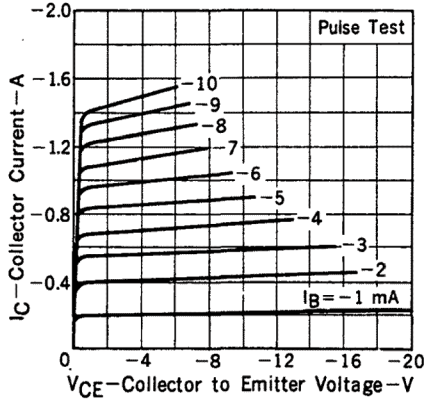

DC CURRENT GAIN, BASE TO EMITTER VOLTAGE vs. COLLECTOR CURRENT

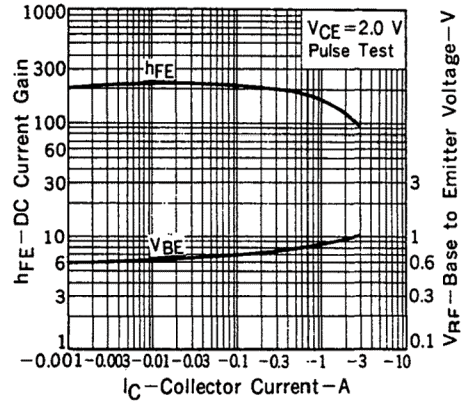

BASE AND COLLECTOR SATURATION VOLTAGE vs. COLLECTOR CURRENT

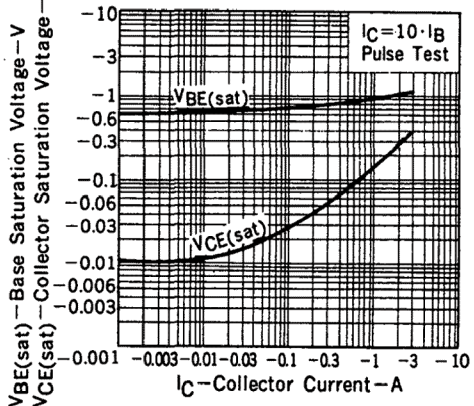

GAIN BANDWIDTH PRODUCT vs. COLLECTOR CURRENT

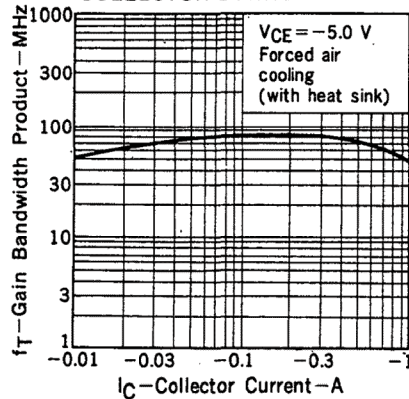

INPUT AND OUTPUT CAPACITANCE vs. REVERSE VOLTAGE

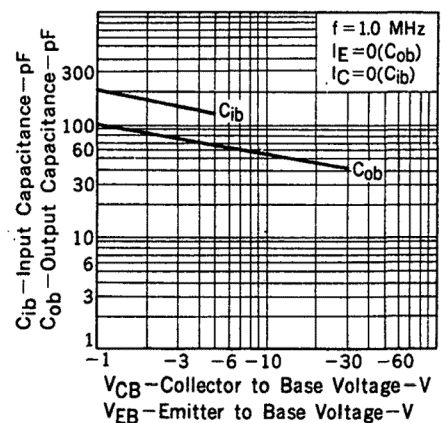

TO-126 PACKAGE OUTLINE DIMENSIONS

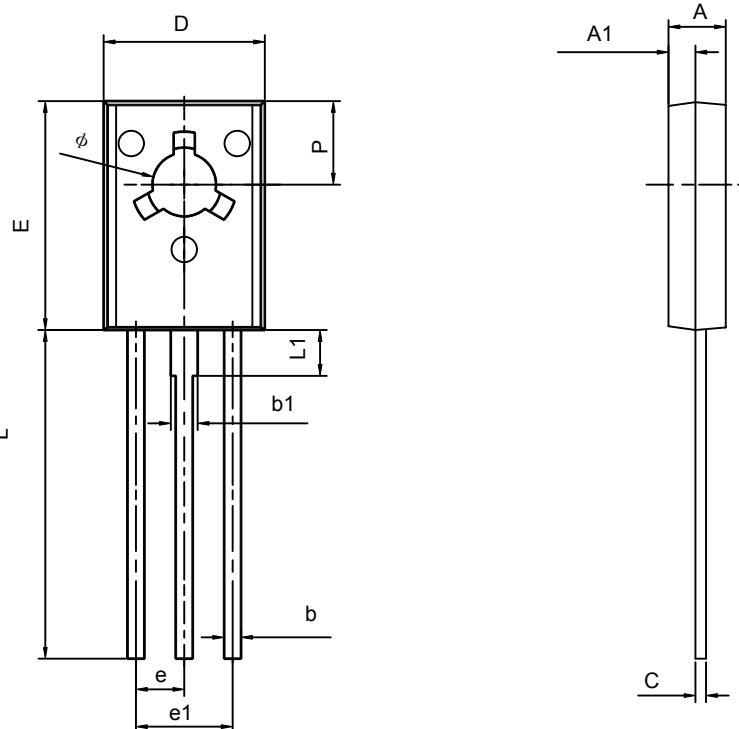

Symbol	Dimensions In Millimeters		Dimensions In Inches	
	Min	Max	Min	Max
A	2.500	2.900	0.098	0.114
A1	1.100	1.500	0.043	0.059
b	0.660	0.860	0.026	0.034
b1	1.170	1.370	0.046	0.054
c	0.450	0.600	0.018	0.024
D	7.400	7.800	0.291	0.307
E	10.600	11.000	0.417	0.433
e	2.290TYP		0.090TYP	
e1	4.480	4.680	0.176	0.184
L	15.300	15.700	0.602	0.618
L1	2.100	2.300	0.083	0.091
P	3.900	4.100	0.154	0.161
ϕ	3.000	3.200	0.118	0.126