



July 1999  
Revised March 2005

## 74LVT240 • 74LVTH240 Low Voltage Octal Buffer/Line Driver with 3-STATE Outputs

### General Description

The LVT240 and LVTH240 are inverting octal buffers and line drivers designed to be employed as memory address drivers, clock drivers and bus oriented transmitters or receivers which provides improved PC board density.

The LVTH240 data inputs include bushold, eliminating the need for external pull-up resistors to hold unused inputs.

These octal buffers and line drivers are designed for low-voltage (3.3V)  $V_{CC}$  applications, but with the capability to provide a TTL interface to a 5V environment. The LVT240 and LVTH240 are fabricated with an advanced BiCMOS technology to achieve high speed operation similar to 5V ABT while maintaining low power dissipation.

### Features

- Input and output interface capability to systems at 5V  $V_{CC}$
- Bushold data inputs eliminate the need for external pull-up resistors to hold unused inputs (74LVTH240), also available without bushold feature (74LVT240)
- Live insertion/extraction permitted
- Power Up/Down high impedance provides glitch-free bus loading
- Outputs source/sink -32 mA/+64 mA
- Functionally compatible with the 74 series 240
- Latch-up performance exceeds 500 mA
- ESD performance:
  - Human-body model > 2000V
  - Machine model > 200V
  - Charged-device model > 1000V

### Ordering Code:

Order Number	Package Number	Package Description
74LVT240WM	M20B	20-Lead Small Outline Integrated Circuit (SOIC), JEDEC MS-013, 0.300" Wide
74LVT240SJ	M20D	Pb-Free 20-Lead Small Outline Package (SOP), EIAJ TYPE II, 5.3mm Wide
74LVT240MSA	MSA20	20-Lead Shrink Small Outline Package (SSOP), JEDEC MO-150, 5.3mm Wide
74LVT240MTC	MTC20	20-Lead Thin Shrink Small Outline Package (TSSOP), JEDEC MO-153, 4.4mm Wide
74LVT240MTCX_NL (Note 1)	MTC20	Pb-Free 20-Lead Thin Shrink Small Outline Package (TSSOP), JEDEC MO-153, 4.4mm Wide
74LVTH240WM	M20B	20-Lead Small Outline Integrated Circuit (SOIC), JEDEC MS-013, 0.300" Wide
74LVTH240SJ	M20D	Pb-Free 20-Lead Small Outline Package (SOP), EIAJ TYPE II, 5.3mm Wide
74LVTH240MSA	MSA20	20-Lead Shrink Small Outline Package (SSOP), JEDEC MO-150, 5.3mm Wide
74LVTH240MTC	MTC20	20-Lead Thin Shrink Small Outline Package (TSSOP), JEDEC MO-153, 4.4mm Wide
74LVTH240MTCX_NL (Note 1)	MTC20	Pb-Free 20-Lead Thin Shrink Small Outline Package (TSSOP), JEDEC MO-153, 4.4mm Wide

Device also available in Tape and Reel. Specify by appending suffix letter "X" to the ordering code.  
Pb-Free package per JEDEC J-STD-020B.

**Note 1:** "\_NL" indicates Pb-Free package (per JEDEC J-STD-020B). Device available in Tape and Reel only.

74LVT240 • 74LVTH240 Low Voltage Octal Buffer/Line Driver with 3-STATE Outputs



### Logic Symbol

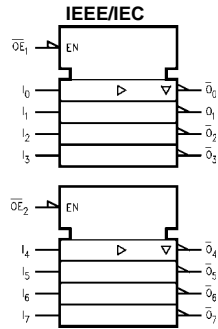

### Connection Diagram

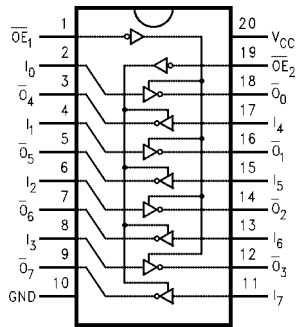

### Pin Descriptions

Pin Names	Description
$\overline{OE}_1, \overline{OE}_2$	3-STATE Output Enable Inputs
$I_0-I_7$	Inputs
$\overline{O}_0-\overline{O}_7$	3-STATE Outputs

### Truth Tables

Inputs		Outputs (Pins 12, 14, 16, 18)
$\overline{OE}_1$	$I_n$	
L	L	H
L	H	L
H	X	Z

Inputs		Outputs (Pins 3, 5, 7, 9)
$\overline{OE}_2$	$I_n$	
L	L	H
L	H	L
H	X	Z

H = HIGH Voltage Level  
 L = LOW Voltage Level  
 X = Immaterial  
 Z = High Impedance

**Absolute Maximum Ratings**(Note 2)

Symbol	Parameter	Value	Conditions	Units
$V_{CC}$	Supply Voltage	-0.5 to +4.6		V
$V_I$	DC Input Voltage	-0.5 to +7.0		V
$V_O$	DC Output Voltage	-0.5 to +7.0	Output in 3-STATE	V
		-0.5 to +7.0	Output in HIGH or LOW State (Note 3)	V
$I_{IK}$	DC Input Diode Current	-50	$V_I < GND$	mA
$I_{OK}$	DC Output Diode Current	-50	$V_O < GND$	mA
$I_O$	DC Output Current	64	$V_O > V_{CC}$ Output at HIGH State	mA
		128	$V_O > V_{CC}$ Output at LOW State	mA
$I_{CC}$	DC Supply Current per Supply Pin	±64		mA
$I_{GND}$	DC Ground Current per Ground Pin	±128		mA
$T_{STG}$	Storage Temperature	-65 to +150		°C

**Recommended Operating Conditions**

Symbol	Parameter	Min	Max	Units
$V_{CC}$	Supply Voltage	2.7	3.6	V
$V_I$	Input Voltage	0	5.5	V
$I_{OH}$	HIGH-Level Output Current		-32	mA
$I_{OL}$	LOW-Level Output Current		64	
$T_A$	Free-Air Operating Temperature	-40	85	°C
$\Delta t/\Delta V$	Input Edge Rate, $V_{IN} = 0.8V-2.0V$ , $V_{CC} = 3.0V$	0	10	ns/V

**Note 2:** Absolute Maximum continuous ratings are those values beyond which damage to the device may occur. Exposure to these conditions or conditions beyond those indicated may adversely affect device reliability. Functional operation under absolute maximum rated conditions is not implied.

**Note 3:**  $I_O$  Absolute Maximum Rating must be observed.

**DC Electrical Characteristics**

Symbol	Parameter	$V_{CC}$ (V)	$T_A = -40^\circ\text{C to } +85^\circ\text{C}$			Units	Conditions	
			Min	Typ (Note 4)	Max			
$V_{IK}$	Input Clamp Diode Voltage	2.7			-1.2	V	$I_I = -18 \text{ mA}$	
$V_{IH}$	Input HIGH Voltage	2.7-3.6	2.0			V	$V_O \leq 0.1V$ or $V_O \geq V_{CC} - 0.1V$	
$V_{IL}$	Input LOW Voltage	2.7-3.6			0.8			
$V_{OH}$	Output HIGH Voltage	2.7-3.6	$V_{CC}-0.2$			V	$I_{OH} = -100 \mu\text{A}$	
		2.7	2.4			V	$I_{OH} = -8 \text{ mA}$	
		3.0	2.0			V	$I_{OH} = -32 \text{ mA}$	
$V_{OL}$	Output LOW Voltage	2.7			0.2	V	$I_{OL} = 100 \mu\text{A}$	
		2.7			0.5	V	$I_{OL} = 24 \text{ mA}$	
		3.0			0.4	V	$I_{OL} = 16 \text{ mA}$	
		3.0			0.5	V	$I_{OL} = 32 \text{ mA}$	
		3.0			0.55	V	$I_{OL} = 64 \text{ mA}$	
$I_{I(HOLD)}$ (Note 5)	Bushold Input Minimum Drive	3.0	75			$\mu\text{A}$	$V_I = 0.8V$	
			-75			$\mu\text{A}$	$V_I = 2.0V$	
$I_{I(OD)}$ (Note 5)	Bushold Input Over-Drive Current to Change State	3.0	500			$\mu\text{A}$	(Note 6)	
			-500			$\mu\text{A}$	(Note 7)	
$I_I$	Input Current	3.6			10	$\mu\text{A}$	$V_I = 5.5V$	
		Control Pins	3.6			±1	$\mu\text{A}$	$V_I = 0V$ or $V_{CC}$
			Data Pins	3.6			-5	$\mu\text{A}$
					1	$\mu\text{A}$	$V_I = V_{CC}$	
$I_{OFF}$	Power Off Leakage Current	0			±100	$\mu\text{A}$	$0V \leq V_I$ or $V_O \leq 5.5V$	
$I_{PU/PD}$	Power up/down 3-STATE Output Current	0-1.5V			±100	$\mu\text{A}$	$V_O = 0.5V$ to $3.0V$ $V_I = GND$ or $V_{CC}$	
$I_{OZL}$	3-STATE Output Leakage Current	3.6			-5	$\mu\text{A}$	$V_O = 0.5V$	
$I_{OZH}$	3-STATE Output Leakage Current	3.6			5	$\mu\text{A}$	$V_O = 3.0V$	

**DC Electrical Characteristics** (Continued)

Symbol	Parameter	V <sub>CC</sub> (V)	T <sub>A</sub> = -40°C to +85°C			Units	Conditions
			Min	Typ (Note 4)	Max		
I <sub>OZH</sub> <sup>+</sup>	3-STATE Output Leakage Current	3.6			10	μA	V <sub>CC</sub> < V <sub>O</sub> ≤ 5.5V
I <sub>CCH</sub>	Power Supply Current	3.6			0.19	mA	Outputs HIGH
I <sub>CCL</sub>	Power Supply Current	3.6			5	mA	Outputs LOW
I <sub>CCZ</sub>	Power Supply Current	3.6			0.19	mA	Outputs Disabled
I <sub>CCZ</sub> <sup>+</sup>	Power Supply Current	3.6			0.19	mA	V <sub>CC</sub> ≤ V <sub>O</sub> ≤ 5.5V, Outputs Disabled
ΔI <sub>CC</sub>	Increase in Power Supply Current (Note 8)	3.6			0.2	mA	One Input at V <sub>CC</sub> - 0.6V Other Inputs at V <sub>CC</sub> or GND

**Note 4:** All typical values are at V<sub>CC</sub> = 3.3V, T<sub>A</sub> = 25°C.

**Note 5:** Applies to bushold versions only (74LVTH240).

**Note 6:** An external driver must source at least the specified current to switch from LOW-to-HIGH.

**Note 7:** An external driver must sink at least the specified current to switch from HIGH-to-LOW.

**Note 8:** This is the increase in supply current for each input that is at the specified voltage level rather than V<sub>CC</sub> or GND.

**Dynamic Switching Characteristics** (Note 9)

Symbol	Parameter	V <sub>CC</sub> (V)	T <sub>A</sub> = 25°C			Units	Conditions C <sub>L</sub> = 50 pF, R <sub>L</sub> = 500Ω
			Min	Typ	Max		
V <sub>OLP</sub>	Quiet Output Maximum Dynamic V <sub>OL</sub>	3.3		0.8		V	(Note 10)
V <sub>OLV</sub>	Quiet Output Minimum Dynamic V <sub>OL</sub>	3.3		-0.8		V	(Note 10)

**Note 9:** Characterized in SOIC package. Guaranteed parameter, but not tested.

**Note 10:** Max number of outputs defined as (n). n-1 data inputs are driven 0V to 3V. Output under test held LOW.

**AC Electrical Characteristics**

Symbol	Parameter	T <sub>A</sub> = -40°C to +85°C C <sub>L</sub> = 50 pF, R <sub>L</sub> = 500Ω					Units
		V <sub>CC</sub> = 3.3V ±0.3V			V <sub>CC</sub> = 2.7V		
		Min	Typ (Note 11)	Max	Min	Max	
t <sub>PLH</sub>	Propagation Delay Data to Output	1.1		3.8	1.1	4.6	ns
t <sub>PHL</sub>		1.3		4.0	1.3	4.2	
t <sub>PZH</sub>	Output Enable Time	1.1		4.6	1.1	5.6	ns
t <sub>PZL</sub>		1.4		4.4	1.4	5.1	
t <sub>PHZ</sub>	Output Disable Time	2.0		4.5	2.0	4.7	ns
t <sub>PLZ</sub>		1.8		4.3	1.8	4.3	
t <sub>OSSL</sub>	Output to Output Skew (Note 12)			1.0		1.0	ns
t <sub>OSLH</sub>							

**Note 11:** All typical values are at V<sub>CC</sub> = 3.3V, T<sub>A</sub> = 25°C.

**Note 12:** Skew is defined as the absolute value of the difference between the actual propagation delay for any two separate outputs of the same device. The specification applies to any outputs switching in the same direction, either HIGH-to-LOW (t<sub>OSSL</sub>) or LOW-to-HIGH (t<sub>OSLH</sub>).

**Capacitance** (Note 13)

Symbol	Parameter	Conditions	Typical	Units
C <sub>IN</sub>	Input Capacitance	V <sub>CC</sub> = 0V, V <sub>I</sub> = 0V or V <sub>CC</sub>	3	pF
C <sub>OUT</sub>	Output Capacitance	V <sub>CC</sub> = 3.0V, V <sub>O</sub> = 0V or V <sub>CC</sub>	6	pF

**Note 13:** Capacitance is measured at frequency f = 1 MHz, per MIL-STD-883, Method 3012.

**Physical Dimensions** inches (millimeters) unless otherwise noted



20-Lead Small Outline Integrated Circuit (SOIC), JEDEC MS-013, 0.300" Wide  
Package Number M20B

**Physical Dimensions** inches (millimeters) unless otherwise noted (Continued)

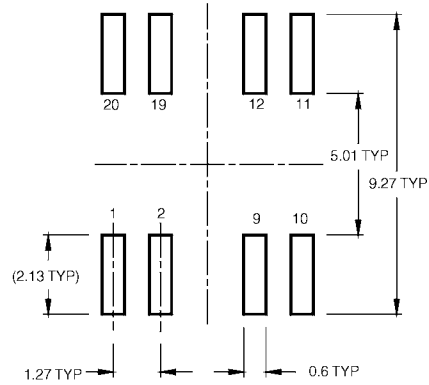
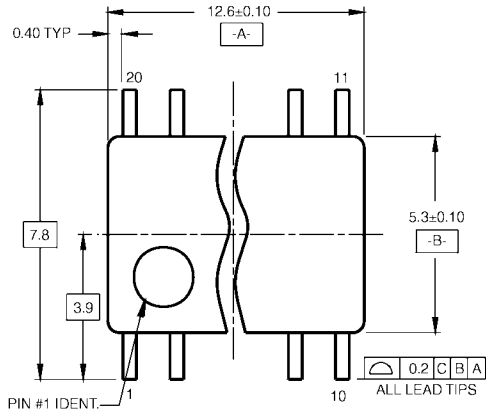

LAND PATTERN RECOMMENDATION

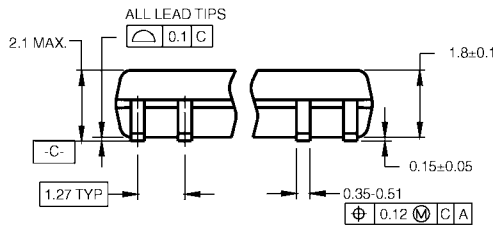

DIMENSIONS ARE IN MILLIMETERS

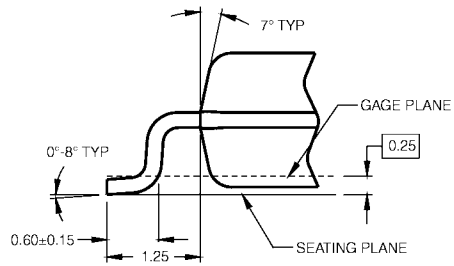
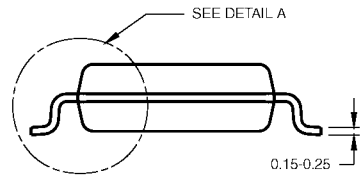

DETAIL A

NOTES:

- A. CONFORMS TO EIAJ EDR-7320 REGISTRATION, ESTABLISHED IN DECEMBER, 1998.
- B. DIMENSIONS ARE IN MILLIMETERS.
- C. DIMENSIONS ARE EXCLUSIVE OF BURRS, MOLD FLASH, AND TIE BAR EXTRUSIONS.

M20DRRevB1

**Pb-Free 20-Lead Small Outline Package (SOP), EIAJ TYPE II, 5.3mm Wide  
Package Number M20D**

**Physical Dimensions** inches (millimeters) unless otherwise noted (Continued)

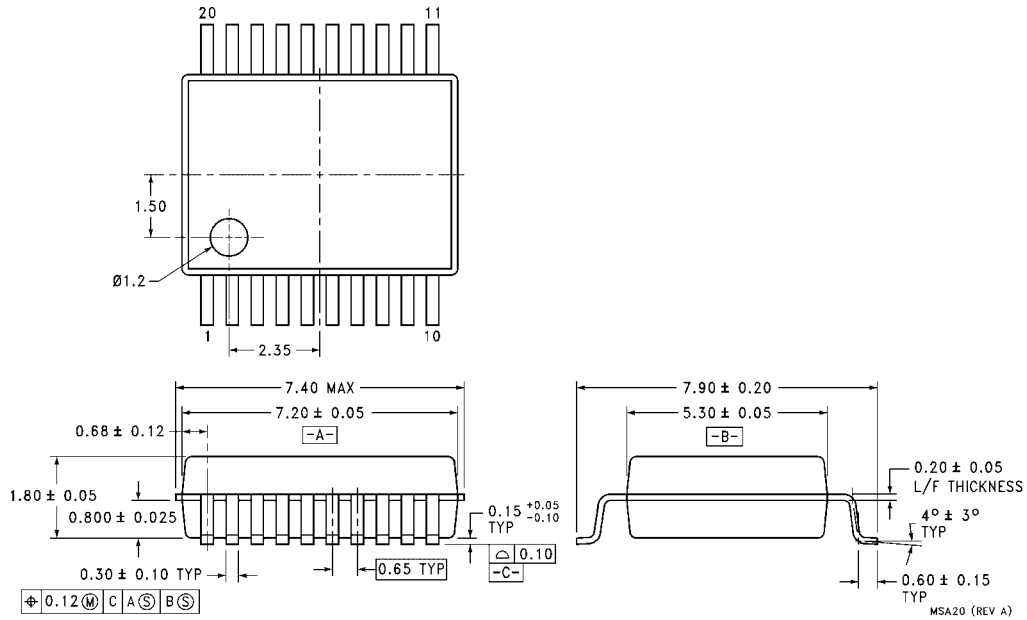

**20-Lead Shrink Small Outline Package (SSOP), JEDEC MO-150, 5.3mm Wide  
 Package Number MSA20**

**Physical Dimensions** inches (millimeters) unless otherwise noted (Continued)

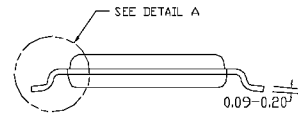
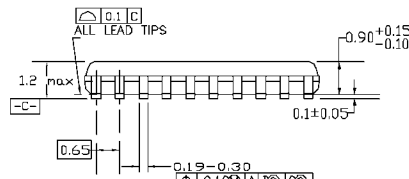
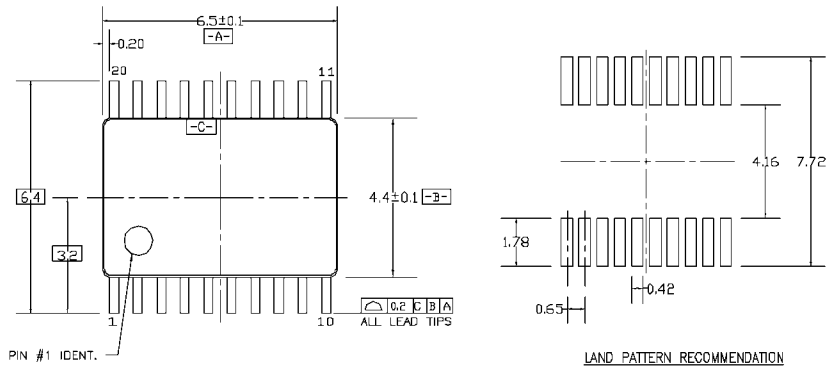

DIMENSIONS ARE IN MILLIMETERS

NOTES:

- A. CONFORMS TO JEDEC REGISTRATION MO-153, VARIATION AC, REF NOTE 6, DATE 7/93.
- B. DIMENSIONS ARE IN MILLIMETERS.
- C. DIMENSIONS ARE EXCLUSIVE OF BURRS, MOLDS FLASH, AND THE BAR EXTRUSIONS.
- D. DIMENSIONS AND TOLERANCES PER ANSI Y14.5M, 1982.

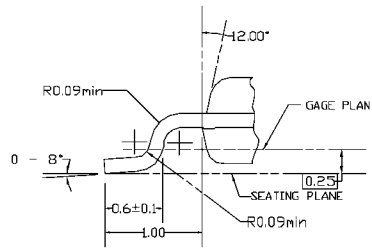

DETAIL A

MTC20REV D1

**20-Lead Thin Shrink Small Outline Package (TSSOP), JEDEC MO-153, 4.4mm Wide Package Number MTC20**

Fairchild does not assume any responsibility for use of any circuitry described, no circuit patent licenses are implied and Fairchild reserves the right at any time without notice to change said circuitry and specifications.

**LIFE SUPPORT POLICY**

FAIRCHILD'S PRODUCTS ARE NOT AUTHORIZED FOR USE AS CRITICAL COMPONENTS IN LIFE SUPPORT DEVICES OR SYSTEMS WITHOUT THE EXPRESS WRITTEN APPROVAL OF THE PRESIDENT OF FAIRCHILD SEMICONDUCTOR CORPORATION. As used herein:

1. Life support devices or systems are devices or systems which, (a) are intended for surgical implant into the body, or (b) support or sustain life, and (c) whose failure to perform when properly used in accordance with instructions for use provided in the labeling, can be reasonably expected to result in a significant injury to the user.
2. A critical component in any component of a life support device or system whose failure to perform can be reasonably expected to cause the failure of the life support device or system, or to affect its safety or effectiveness.

[www.fairchildsemi.com](http://www.fairchildsemi.com)