

1-stage inlet filter, front side mounting, line switch 2-pole, fuseholder 5x20 mm 2-pole

Standard- or Medical-Filter



new



C14



70° C



Description

- Panel Mount:
Screw-on from front side
- 4 Functions:
Inlet Protection class I, Line switch 2-pole, Fuseholder for fuse-links 5 x 20 mm 2-pole, Line filter in standard and medical version
- Quick connect terminals 6.3 x 0.8 mm

Approvals

- VDE License Number: 40004665
- UL License Number: E76360

Characteristics

- Compact design with optimal shielding
- All single elements are already wired
- Plug removal necessary for fuse-link replacement
If the power entry module is installed as normal, it is not possible to touch any live parts with the test-finger according to IEC60529
Fuse drawer meets requirements of medical standard IEC/EN 60601-1
The fuseholder is accessible from the equipment front
- With EMC-shield
- Qualified for use in equipment according IEC/EN 60950

References

[General Product Information](#)

Weblinks

[Approvals](#), [RoHS](#), [CHINA-RoHS](#), [e-Store](#), [SCHURTER-Stock-Check](#), [Distributor-Stock-Check](#)

Technical Data

Ratings IEC	1 - 10A @ Ta 40 °C / 250VAC; Hz 50
Ratings UL/CSA	1 - 10A @ Ta 40 °C / 125VAC; 60Hz
Leakage Current	standard < 0.25mA (250V / 60Hz) medical < 5 µA (250 V / 60 Hz)
Dielectric Strength	> 1.7kVDC between L-N > 2.7kVDC between L/N-PE Test voltage (2 sec)
Allowable Operation Temp.	-25 °C to 85 °C
Climatic Category	25/085/21 acc. to IEC 60068-1
Degree of Protection	from front side IP 40 acc. to IEC 60529
Protection Class	Suitable for appliances with protection class I acc. to IEC 61140
Terminal	Quick connect terminals 6.3 x 0.8 mm
Panel Thickness s	Screw-on: max 8 mm Mounting screw torque max 0.5Nm
Material: Housing	Thermoplastic, black, UL 94V-0

Appliance-Inlet /-Outlet	C14 acc. to IEC/EN 60320-1, UL 498, CSA C22.2 no. 42 (for cold condition) pin-temperature 70 °C, 10A, Protection class I
Fuseholder	2-pole, Shocksafe category PC2 acc. to IEC 60127-6, for fuse-links 5 x 20mm
Rated Power Acceptance @ Ta 23 °C	5 x 20: 1.6W (2-pole)
Power Acceptance @ Ta > 23°C	Admissible power acceptance at higher ambient temperature see derating curves
Line Switch	Rocker switch 2-pole, non-illuminated, acc. to IEC 61058-1 Technical details
Line Filter	Standard and Medical Version, IEC 60939, IEC 60601-1, UL 1283, UL 544, EN 133 200, CSA C22.2 no. 8 Technical details
MTBF	> 1'700'000h acc. to MIL-HB-217 F

Dimensions

Case 50

Length |-----| 55 mm

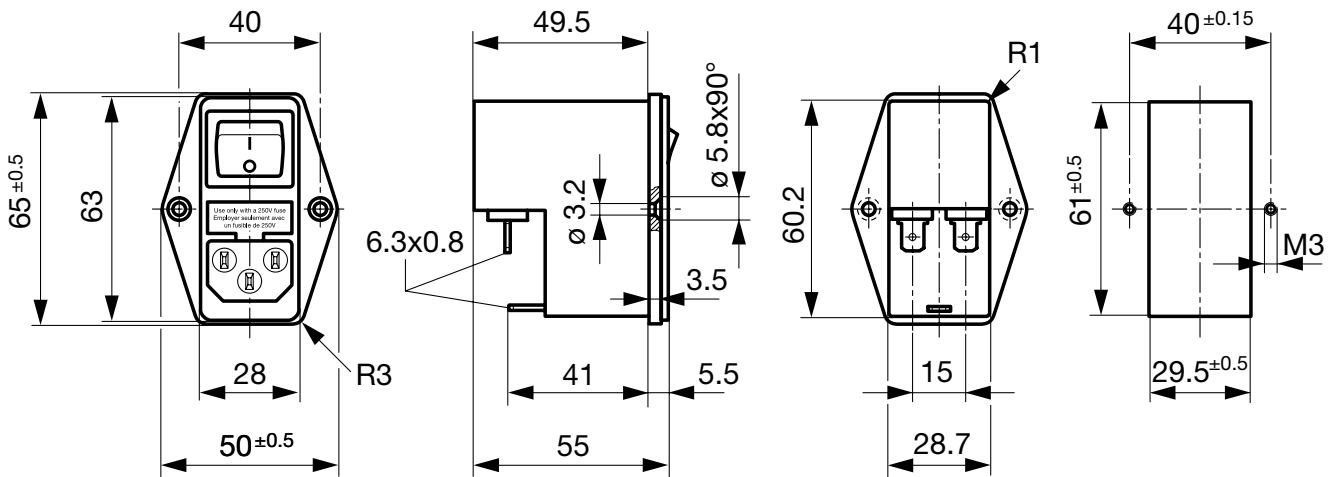

Case 45

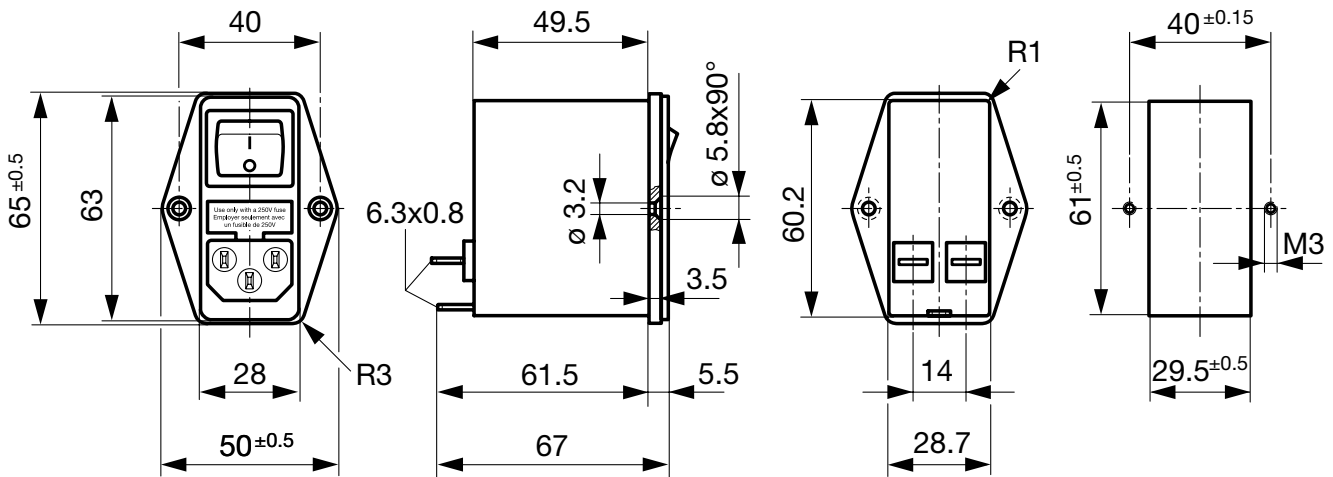

Technical Data of Filter-Components

Rated Current [A]	Filter-Type	Inductances L [mH]	Capacitance CX [nF]	Capacitance CY [nF]	R [MΩ]
1	Standard Version	2 x 10	68	2.2	1
2	Standard Version	2 x 4	68	2.2	1
4	Standard Version	2 x 1.5	68	2.2	1
6	Standard Version	2 x 0.8	68	2.2	1
10	Standard Version	2 x 0.3	68	2.2	1
1	Medical Version (M5)	2 x 10	68	-	1
2	Medical Version (M5)	2 x 4	68	-	1
4	Medical Version (M5)	2 x 1.5	68	-	1
6	Medical Version (M5)	2 x 0.8	68	-	1
10	Medical Version (M5)	2 x 0.3	68	-	1
2	Medical Version (M80)	2 x 10	68	2.2	1

Diagrams

Standard Version

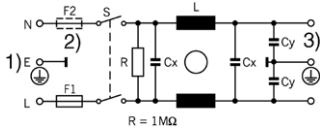

- 1) Line
- 2) only FKI
- 3) Load

Derating Curves for Fuseholders

2-pole (per pole)

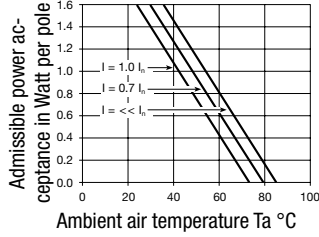

Attenuation Loss

--- differential mode ____ common mode

Standard version

1 A

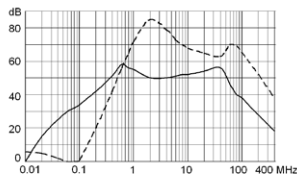

2 A

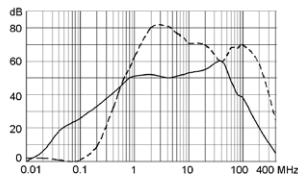

4 A

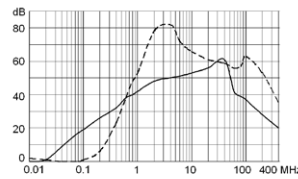

6 A

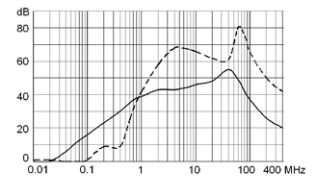

10 A

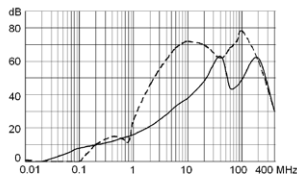

Medical version (M5)

1 A

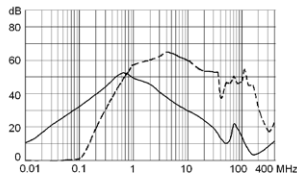

2 A

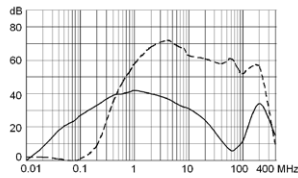

4 A

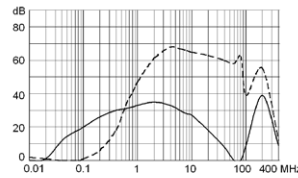

6 A

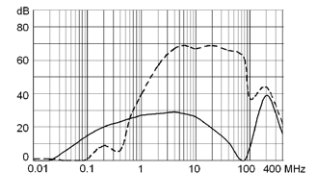

10 A

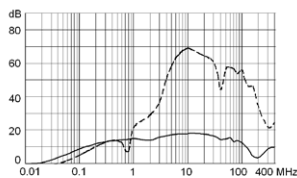

Variants

Socket and fuse drawer included

Type	Rated Current [A]	Filter-Type	Fuseholder	Line Switch	Case	Material: Housing	Order Number
FKI	1	Standard Version	2-pole	2-pole	45	Aluminum	4304.4061
FKI	2	Standard Version	2-pole	2-pole	45	Aluminum	4304.4062
FKI	4	Standard Version	2-pole	2-pole	45	Aluminum	4304.4063
FKI	6	Standard Version	2-pole	2-pole	45	Aluminum	4304.4064
FKI	10	Standard Version	2-pole	2-pole	45	Aluminum	4304.4065
FKI	1	Standard Version	2-pole	2-pole	50	Nickel plated steel	4304.4021
FKI	2	Standard Version	2-pole	2-pole	50	Nickel plated steel	4304.4022
FKI	4	Standard Version	2-pole	2-pole	50	Nickel plated steel	4304.4023
FKI	6	Standard Version	2-pole	2-pole	50	Nickel plated steel	4304.4024
FKI	10	Standard Version	2-pole	2-pole	50	Nickel plated steel	4304.4025
FKI	1	Medical Version (M5)	2-pole	2-pole	50	Nickel plated steel	4304.4066
FKI	2	Medical Version (M5)	2-pole	2-pole	50	Nickel plated steel	4304.4067
FKI	4	Medical Version (M5)	2-pole	2-pole	50	Nickel plated steel	4304.4068
FKI	6	Medical Version (M5)	2-pole	2-pole	50	Nickel plated steel	4304.4069
FKI	10	Medical Version (M5)	2-pole	2-pole	50	Nickel plated steel	4304.4070

Packaging unit 10 Pcs

Accessory

Description

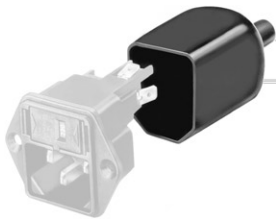

Assorted Covers
Rear Cover

0859.0074