



February 2005

# LM4970 Boomer® Audio Power Amplifier Series Audio Synchronized Color LED Driver

## General Description

The LM4970 is a LED driver with an audio synchronization mode that virtually eliminates the need for real time software processing for LED lighting effects. The LM4970 includes three individual PWM color LED drivers that provide up to 42mA of current drive for each PWM LED output.

The LM4970 features an audio synchronization mode where the audio input signal that is mixed in from three audio inputs is filtered into three frequency bands, with each frequency band assigned to a specific PWM LED driver.

The PWM LED drivers can also be directly programmed through an I<sup>2</sup>C compatible interface for applications where user defined LED pattern, color, and intensity programmability is a priority.

The LM4970 also features an audio input gain control which allows the user to increase the gain if the audio input signal does not create a bright enough effect on the LEDs. The LM4970 is a feature rich LED driver that is available in a space saving 14 pin non-pullback LLP package.

## Key Specifications

- LED Drive Current per channel  
V<sub>DD</sub> = 5V 42mA (2X setting)
- Shutdown Current, V<sub>DD</sub> = 5V 1.5µA (typ)

## Features

- Audio synchronized color LED driver
- User defined LED pattern, color, and intensity capability
- Programmable:
  - LED Drive current
  - PWM frequency
  - High pass filter frequency select
  - Audio input signal gain
- Eliminates external LED current limiting resistors
- I<sup>2</sup>C compatible interface
- Ultra low shutdown current

## Applications

- Cell Phones
- Portable MP3, CD, DVD, AAC players
- PDA's

## Block Diagram

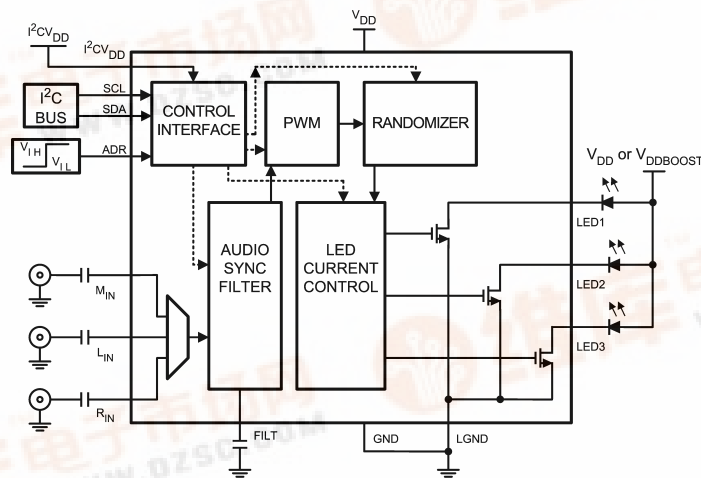

20121201

FIGURE 1. Block Diagram

LM4970 Audio Synchronized Color LED Driver



## Connection Diagram

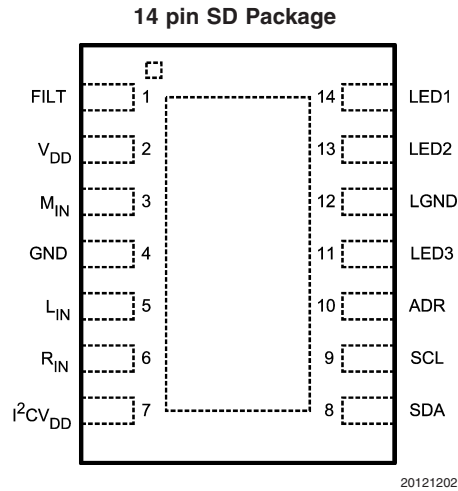

**Top View**  
**Order Number LM4970SD**  
**See NS Package Number SDA14A**

## Pin Connection

Pin	Name	Pin Description
1	FILT	Low Pass Filter Input
2	V <sub>DD</sub>	Power Supply Pin
3	M <sub>IN</sub>	Mono Audio Input
4	GND	Ground
5	L <sub>IN</sub>	Left Audio Input
6	R <sub>IN</sub>	Right Audio Input
7	I <sup>2</sup> CV <sub>DD</sub>	I <sup>2</sup> C Interface Power Supply
8	SDA	I <sup>2</sup> C Data
9	SCL	I <sup>2</sup> C Clock
10	ADR	I <sup>2</sup> C Address Select
11	LED3	LED output 3
12	LGND	LED ground
13	LED2	LED output 2
14	LED1	LED output 1

**Absolute Maximum Ratings** (Notes 1, 2)

If Military/Aerospace specified devices are required, please contact the National Semiconductor Sales Office/Distributors for availability and specifications.

Supply Voltage	6.0V
Storage Temperature	-65°C to +150°C
Input Voltage	-0.3V to $V_{DD} + 0.3V$
Power Dissipation (Note 3)	Internally Limited
ESD Susceptibility (Note 4)	2000V
ESD Susceptibility (Note 5)	200V
ESD Susceptibility (Note 12)	100V
Junction Temperature	150°C

Thermal Resistance

$\theta_{JA}$ (SDA14A)	57°C/W
$\theta_{JC}$ (SDA14A)	12°C/W

**Operating Ratings**

Temperature Range

$$T_{MIN} \leq T_A \leq T_{MAX} \quad -40^\circ\text{C} \leq T_A \leq +85^\circ\text{C}$$

Supply Voltage

$$2.7V \leq V_{DD} \leq 5.5V \text{ (Note 13)}$$

$$2.5V \leq I^2CV_{DD} \leq 5.5V$$

**Control Interface Electrical Characteristics** (Notes 1, 2)

The following specifications apply for  $3V \leq V_{DD} \leq 5V$  unless otherwise specified. Limits apply for  $T_A = 25^\circ\text{C}$ .

Symbol	Parameter	Conditions	LM4970		Units (Limits)
			Typical (Note 6)	Limits (Notes 7, 8)	
$t_1$	SCL period			2.5	$\mu\text{s}$ (min)
$t_2$	SDA Setup Time			100	ns (min)
$t_3$	SDA Stable Time			0	ns (min)
$t_4$	Start Condition Time			100	ns (min)
$t_5$	Stop Condition Time			100	ns (min)
$V_{IH}$	Digital Input High Voltage			$0.7 \times I^2CV_{DD}$	V (min)
$V_{IL}$	Digital Input Low Voltage			$0.3 \times I^2CV_{DD}$	V (max)

**Color LED Driver Electrical Characteristics  $V_{DD} = 5.0V$**  (Notes 1, 2, 9)

The following specifications apply for  $V_{DD} = 5.0V$  unless otherwise specified. Limits apply for  $T_A = 25^\circ\text{C}$ .

Symbol	Parameter	Conditions	LM4970		Units (Limits)
			Typical (Note 6)	Limits (Notes 7, 8)	
$I_{DDRGB}$	Supply Current		2.5	4	mA (max)
$I_{SDRGB}$	Shutdown Current	Shutdown Mode	1.5	3.5	$\mu\text{A}$ (max)
$I_{LED}$	LED Drive Current	.66X current drive setting	14		mA
		1X current drive setting	21		mA
		1.33X current drive setting	30		mA
		2X current drive setting	42	23	mA (min)
$f_{PWM}$	PWM Frequency	PWM_F<1:0> = '01'	60		Hz
	Input Signal Level Gain Control	Maximum setting	12		dB
		Minimum setting	-11		dB

**Color LED Driver Electrical Characteristics  $V_{DD} = 3.0V$**  (Notes 1, 2, 9)

The following specifications apply for  $V_{DD} = 3.0V$  unless otherwise specified. Limits apply for  $T_A = 25^\circ\text{C}$ .

Symbol	Parameter	Conditions	LM4970		Units (Limits)
			Typical (Note 6)	Limits (Notes 7, 8)	
$I_{DDRGB}$	Supply Current		2.2	3	mA (max)
$I_{SDRGB}$	Shutdown Current	Shutdown Mode	0.5	2	$\mu\text{A}$ (max)
$I_{LED}$	LED Drive Current	.66X current drive setting	12		mA
		1X current drive setting	18		mA
		1.33X current drive setting	27		mA
		2X current drive setting	35	21	mA (min)

## Color LED Driver Electrical Characteristics $V_{DD} = 3.0V$ (Notes 1, 2, 9) (Continued)

The following specifications apply for  $V_{DD} = 3.0V$  unless otherwise specified. Limits apply for  $T_A = 25^\circ C$ .

Symbol	Parameter	Conditions	LM4970		Units (Limits)
			Typical (Note 6)	Limits (Notes 7, 8)	
$f_{PWM}$	PWM Frequency	PWM_F<1:0> = '01'	60		Hz
	Input Signal Level Gain Control	Maximum setting	12		dB
		Minimum setting	-11		dB

**Note 1:** All voltages are measured with respect to the GND pin unless otherwise specified.

**Note 2:** Absolute Maximum Ratings indicate limits beyond which damage to the device may occur. Operating Ratings indicate conditions for which the device is functional but do not guarantee specific performance limits. Electrical Characteristics state DC and AC electrical specifications under particular test conditions which guarantee specific performance limits. This assumes that the device is within the Operating Ratings. Specifications are not guaranteed for parameters where no limit is given, however, the typical value is a good indication of device performance.

**Note 3:** The maximum power dissipation must be derated at elevated temperatures and is dictated by  $T_{JMAX}$ ,  $\theta_{JA}$ , and the ambient temperature,  $T_A$ . The maximum allowable power dissipation is  $P_{DMAX} = (T_{JMAX} - T_A) / \theta_{JA}$  or the number given in Absolute Maximum Ratings, whichever is lower.

**Note 4:** Human body model, 100pF discharged through a 1.5k $\Omega$  resistor.

**Note 5:** Machine Model, 200pF–220pF discharged through all pins, except pins 13 and 14.

**Note 6:** Typicals are measured at +25°C and represent the parametric norm.

**Note 7:** Limits are guaranteed to National's AOQL (Average Outgoing Quality Level).

**Note 8:** Datasheet min/max specification limits are guaranteed by design, test, or statistical analysis.

**Note 9:** Shutdown current and supply current are measured in a normal room environment. All digital input pins are connected to  $I^2CV_{DD}$ .

**Note 10:** The given  $\theta_{JA}$  is for an LM4970SD mounted on a PCB with a 2in<sup>2</sup> area of 1oz printed circuit board copper ground plane.

**Note 11:** Audio input level set at 1V<sub>RMS</sub>. The input summing amplifier gain is set to 12dB.

**Note 12:** Machine Model, 200pF–220pF discharge through pins 13 and 14 (LED1 and LED2).

**Note 13:**  $V_{DD}$  may be used to power the LEDs. It may be necessary to drive the LEDs from a boost ( $V_{DDBOOST}$ ) found within the system.

## External Components Description

Components		Functional Description
1.	$C_i$	This is the input coupling capacitor. It blocks the DC voltage and couples the input signal to the amplifier's input terminals. $C_{IN}$ also creates a highpass filter with an internal 20kΩ resistor at $f_c = 1/(2\pi \cdot 20000 \cdot C_i)$ .
2.	$C_S$	This is the supply bypass capacitor. It filters the supply voltage applied to the $V_{DD}$ pin and helps reduce the noise at the $V_{DD}$ pin.
3.	$C_{filt}$	This capacitor creates a low pass filter with an internal 4kΩ resistor at $f_c = 1/(2\pi \cdot 4000 \cdot C_{filt})$ . This pole set at $f_c$ determines the high cutoff frequency for the low band PWM color LED driver output, LED1.

## Typical Performance Characteristics (Note 11)

**Audio Sync LED Frequency Response**  
(Left - lowband, Mid - midband, Right - highband)  
( $C_{filt} = 0.047\mu F$ , HPF = 3.5kHz setting)

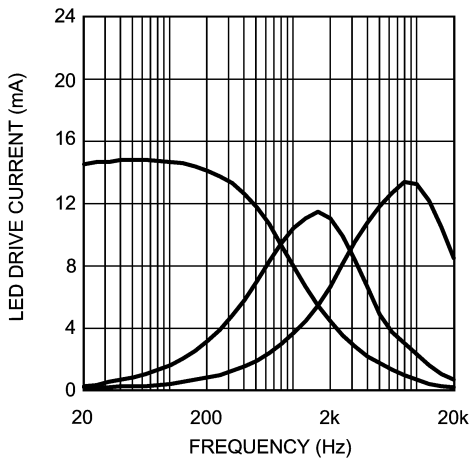

20121265

**Audio Sync LED Frequency Response**  
(Left - lowband, Mid - midband, Right - highband)  
( $C_{filt} = 0.068\mu F$ , HPF = 3.5kHz setting)

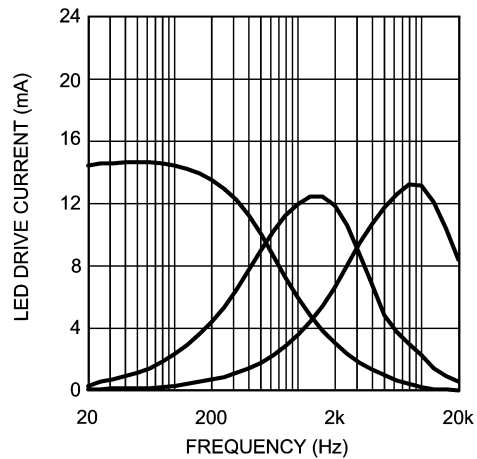

20121266

**Audio Sync LED Frequency Response**  
(Left - lowband, Mid - midband, Right - highband)  
( $C_{filt} = 0.1\mu F$ , HPF = 3.5kHz setting)

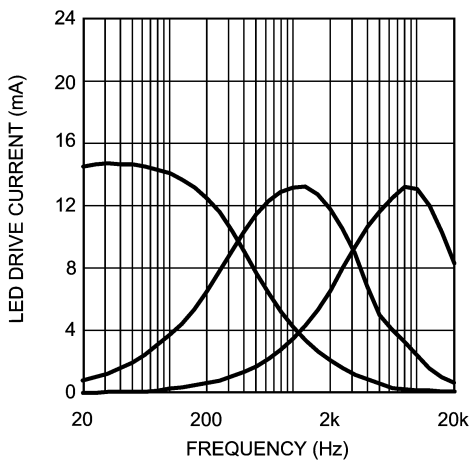

20121267

**Audio Sync LED Frequency Response**  
(Left - lowband, Mid - midband, Right - highband)  
( $C_{filt} = 0.22\mu F$ , HPF = 3.5kHz setting)

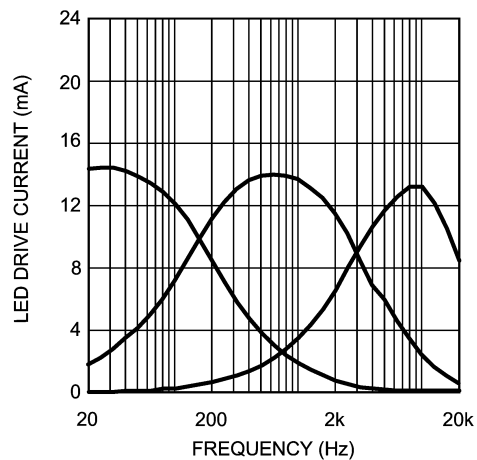

20121268

## Typical Performance Characteristics (Note 11) (Continued)

**Audio Sync LED Frequency Response**  
 (Left - lowband, Mid - midband, Right - highband)  
 (Cfilt = 0.47 $\mu$ F, HPF = 3.5kHz setting)

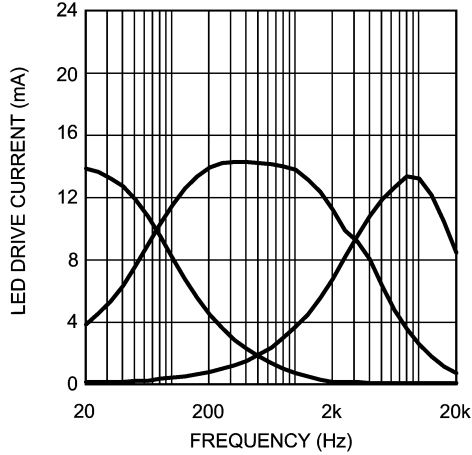

20121269

**Audio Sync LED Frequency Response**  
 (Left - lowband, Mid - midband, Right - highband)  
 (Cfilt = 0.68 $\mu$ F, HPF = 3.5kHz setting)

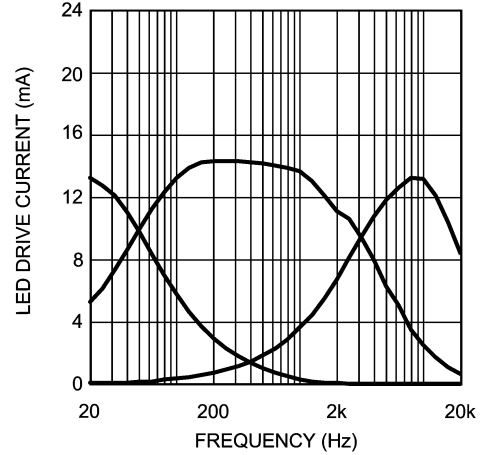

20121270

**Audio Sync LED Frequency Response**  
 (Left - lowband, Mid - midband, Right - highband)  
 (Cfilt = 1 $\mu$ F, HPF = 3.5kHz setting)

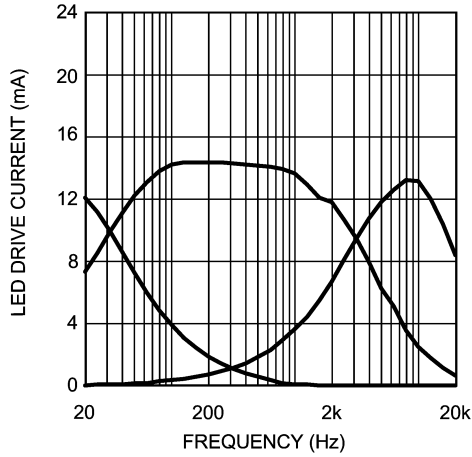

20121271

**Audio Sync LED Frequency Response**  
 (Left - lowband, Mid - midband, Right - highband)  
 (Cfilt = 2.2 $\mu$ F, HPF = 3.5kHz setting)

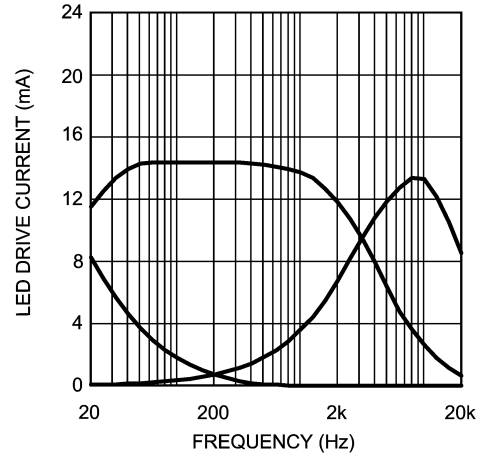

20121272

**Typical Performance Characteristics** (Note 11) (Continued)

**Highpass Filter Frequency Response vs HPF\_F<1:0> setting**  
 (Top - 3.5kHz setting, Mid - 6.3kHz setting, Bot - 8.9kHz setting)

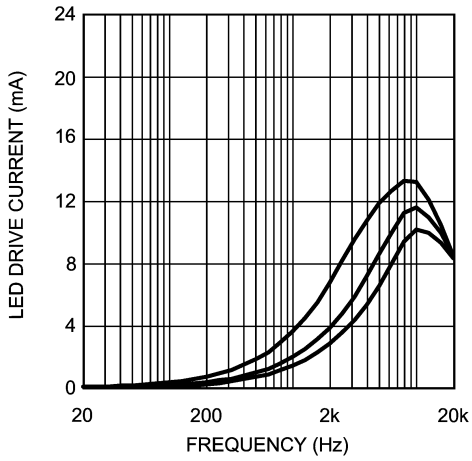

20121273

**Low Pass Filter Frequency Response vs Cfilt**  
 (From Left to Right: Cfilt (μF) = 2.2, 1.0, 0.68, 0.47, 0.22, 0.1, 0.068, 0.047, No Cfilt)

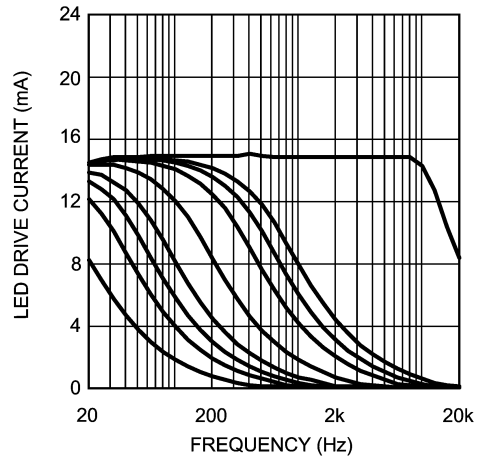

20121274

## Application Information

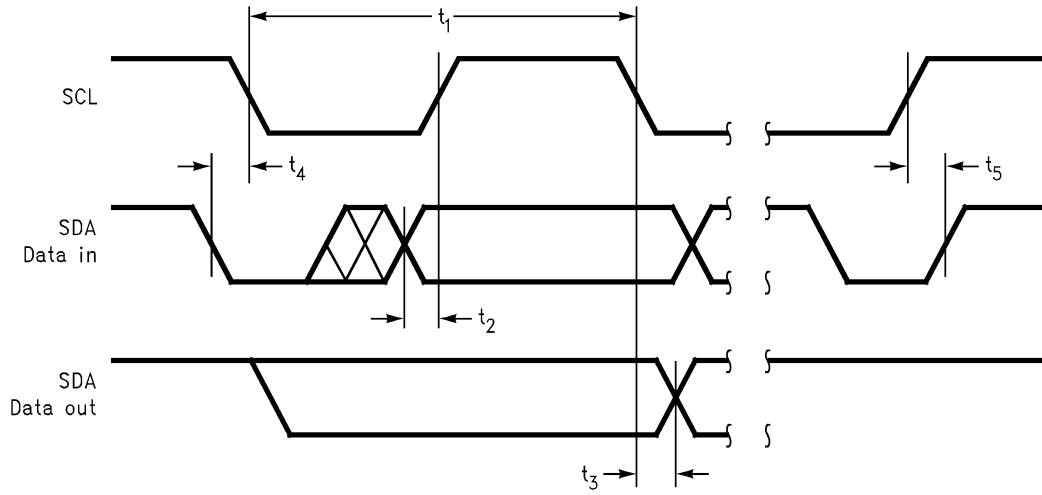

201212F4

FIGURE 2. I<sup>2</sup>C Timing Diagram

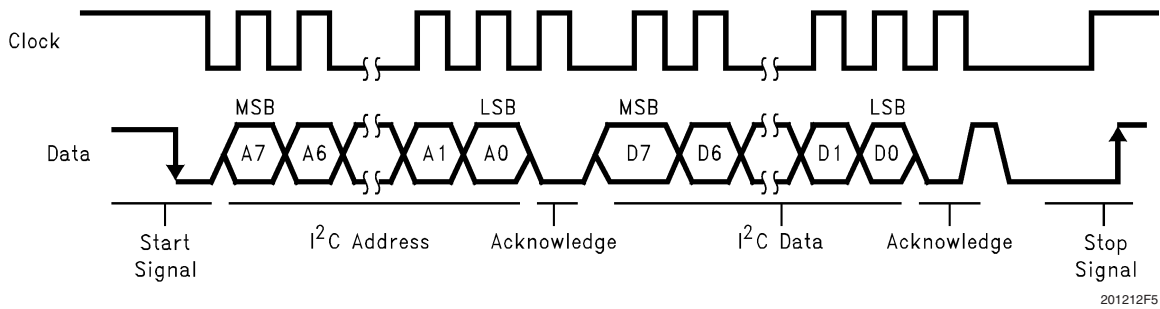

201212F5

FIGURE 3. I<sup>2</sup>C Bus Format

TABLE 1. Color LED Driver Chip Address

	A7	A6	A5	A4	A3	A2	A1	A0
Chip Address	1	1	1	1	0	1	EC	0
ADR = 0	1	1	1	1	0	1	0	0
ADR = 1	1	1	1	1	0	1	1	0

EC - externally configured by ADR pin

TABLE 2. Color LED Driver Control Registers

Register Name	D7	D6	D5	D4	D3	D2	D1	D0
Mode Select	0	0	0	MS4	MS3	MS2	MS1	MS0
Frequency Select	0	1	0	FS4	FS3	FS2	FS1	FS0
Pattern Select	1	1	1	PS4	PS3	PS2	PS1	PS0
Current Select	1	0	CS5	CS4	CS3	CS2	CS1	CS0
Gain Select	1	1	GS5	GS4	GS3	GS2	GS1	GS0



## Application Information (Continued)

**TABLE 3. Mode Select Register**

Data Bit	Bit Name	Default Value	Condition	Function
MS0	I <sup>2</sup> C_SD	1	0	Enables device power up mode
			1	Enables device shutdown mode
MS1	I <sup>2</sup> C_RST	0	0	Enables device normal operation
			1	Enables device RESET, excluding the I <sup>2</sup> C register settings
MS2	RAND	1	0	Disables the audio synchronization randomizer
			1	Enables the audio synchronization randomizer
MS3	RSVD	0	0	RESERVED
			1	
MS4	RSVD	0	0	RESERVED
			1	

**TABLE 4. Frequency Select Register**

Data Bit	Bit Name	Default Value	Condition	Function	
FS0	PWM_F0	0	0	Programs the oscillation frequency of the PWM. PWM oscillation frequency is set as follows:	
			1		<b>PWM_F&lt;1:0&gt;</b>
FS1	PWM_F1	0	0	00	15kHz
				01	60Hz
			1	10	7Hz
				11	4Hz
FS2	RSVD	0	0	RESERVED	
			1		
FS3	HPF_F0	0	0	Programs the internal high pass filter cutoff frequency. High pass filter cutoff frequency is set as follows:	
			1		
FS4	HPF_F1	1	0	HPF_F<1:0>	High Pass Filter Cutoff Frequency
			1	00	3.5kHz
				01	6.3kHz
				10	6.3kHz
				11	8.9kHz

## Application Information (Continued)

**TABLE 5. Pattern Select Register**

Data Bit	Bit Name	Default Value	Condition	Function
PS0	I <sup>2</sup> C_SEL	0	0	Enables LED drivers to be controlled by audio synchronization
			1	Enables LED drivers to be controlled through I <sup>2</sup> C
PS1	I <sup>2</sup> C_LED1	0	0	Disables the LED1 driver, if I <sup>2</sup> C_SEL is set
			1	Enables the LED1 driver, if I <sup>2</sup> C_SEL is set
PS2	I <sup>2</sup> C_LED2	0	0	Disables the LED2 driver, if I <sup>2</sup> C_SEL is set
			1	Enables the LED2 driver, if I <sup>2</sup> C_SEL is set
PS3	I <sup>2</sup> C_LED3	0	0	Disables the LED3 driver, if I <sup>2</sup> C_SEL is set
			1	Enables the LED3 driver, if I <sup>2</sup> C_SEL is set
PS4	RSVD	0	0	RESERVED
			1	RESERVED

**TABLE 6. Current Select Register**

Data Bit	Bit Name	Default Value	Condition	Function	
CS0	ILED1_0	0	0	Programs the current drive of the LED1 driver. Current drive for LED1 is set as follows:	
			1	<b>ILED1&lt;1:0&gt;</b>	<b>Current Drive Setting</b>
CS1	ILED1_1	1	0	00	0.66X
				01	1X
			1	10	1.33X
				11	2X
CS2	ILED2_0	0	0	Programs the current drive of the LED2 driver. Current drive for LED2 is set as follows:	
			1	<b>ILED2&lt;1:0&gt;</b>	<b>Current Drive Setting</b>
CS3	ILED2_1	1	0	00	0.66X
				01	1X
			1	10	1.33X
				11	2X
CS4	ILED3_0	0	0	Programs the current drive of the LED3 driver. Current drive for LED3 is set as follows:	
			1	<b>ILED3&lt;1:0&gt;</b>	<b>Current Drive Setting</b>
CS5	ILED3_1	1	0	00	0.66X
				01	1X
			1	10	1.33X
				11	2X

## Application Information (Continued)

**TABLE 7. Gain Select Register**

Data Bit	Bit Name	Default Value	Condition	Function	
GSO	MGAIN0	0	0	Programs the gain response of the midband audio synchronized filter which drives the LED2 PWM color LED driver for the midband audio frequencies. Gain is set as follows:	
			1		
GS1	MGAIN1	1	0	<b>MGAIN&lt;2:0&gt;</b>	<b>Midband Filter Gain</b>
			1		
GS2	MGAIN2	0	0	000	minimum
			1	001	low
				010	medium
				011	high
				100	maximum
GS3	SGAIN0	0	0	Programs the audio gain of the input summing amplifier. Gain is set as follows:	
			1		
GS4	SGAIN1	1	0	000	-11dB
			1	001	-6.5dB
GS5	SGAIN2	0	0	010	0dB
				011	3.5dB
			1	100	6dB
				101	10dB
				110	12dB

## Application Information (Continued)

### I<sup>2</sup>C COMPATIBLE INTERFACE

The LM4970 uses a serial bus which conforms to the I<sup>2</sup>C protocol to control the chip's functions with two wires: clock (SCL) and data (SDA). The clock line is uni-directional. The data line is bi-directional (open-collector) with a pullup resistor (typically 10kΩ). The maximum clock frequency specified by the I<sup>2</sup>C standard is 400kHz. In this discussion, the master is the controlling microcontroller and the slave is the LM4970.

The I<sup>2</sup>C address for the LM4970 is determined using the ADR pin. The LM4970's two possible I<sup>2</sup>C chip addresses are of the form 111101X<sub>1</sub>0 (binary), where X<sub>1</sub> = 0, if ADR is logic low; and X<sub>1</sub> = 1, if ADR is logic high. If the I<sup>2</sup>C interface is used to address a number of chips in a system, the LM4970's chip address can be changed to avoid any possible address conflicts.

The bus format for the I<sup>2</sup>C interface is shown in Figure 3. The data is latched in on the rising edge of the clock. The bus format diagram is broken up into six major sections:

The "start" signal is generated by lowering the data signal while the clock signal is high. The start signal will alert all devices attached to the I<sup>2</sup>C bus to check the incoming address against their own address.

The 8-bit chip address is sent next, most significant bit first. Each address bit must be stable while the clock level is high.

After the last bit of the address bit is sent, the master checks for the LM4970's acknowledge. The master releases the data line high (through a pullup resistor). Then the master sends a clock pulse. If the LM4970 has received the address correctly, then it holds the data line low during the clock pulse. If the data line is not low, then the master should send a "stop" signal (discussed later) and abort the transfer.

The 8 bits of data are sent next, most significant bit first. Each data bit should be valid while the clock level is stable high.

After the data byte is sent, the master must check for another acknowledge to see if the LM4970 received the data.

If the master has more data bytes to send to the LM4970, then the master can repeat the previous two steps until all data bytes have been sent.

The "stop" signal ends the transfer. To signal "stop", the data signal goes high while the clock signal is high. The data line should be held high when not in use.

### AUDIO SYNCHRONIZATION MODE

The LM4970 features an audio synchronization mode where each PWM color LED driver output is dependent on the audio input signal. The audio synchronization mode allows each LED output to react to the amplitude of the audio input signal, according to the LED output's assigned frequency band. Audio synchronization mode is activated by clearing the I2C\_SEL bit in the Pattern Select Register.

The audio synchronization filter separates the mixed audio signal into three frequency bands: lowband, midband, and highband. Each frequency band is assigned to a particular PWM LED output, with lowband controlling the duty cycle of the LED1 output, midband controlling the duty cycle of the LED2 output, and highband controlling the duty cycle of the LED3 output. This occurs whenever the audio synchronization randomizer is not turned on. The operation of the audio synchronization randomizer is explained in the **Audio Synchronization Randomizer** section. The duty cycle of any

given LED output is dependent upon the amplitude of the audio signal for its particular frequency band. An increase in the amplitude of the audio signal will increase the duty cycle of the PWM LED driver. LEDs driven with a higher duty cycle results in a brighter lighting effect.

The LM4970 has three single-ended analog audio inputs designated M<sub>IN</sub>, L<sub>IN</sub>, and R<sub>IN</sub>, where mono voice data is routed to M<sub>IN</sub> and stereo MP3 or stereo FM radio data is routed to L<sub>IN</sub> and R<sub>IN</sub>. Audio signals coupled in from M<sub>IN</sub>, L<sub>IN</sub>, and R<sub>IN</sub> are mixed together by an audio input summing amplifier. The gain of the audio input summing amplifier is programmed by the SGAIN<2:0> bits of the Gain Select Register. Increasing the gain of the audio input summing amplifier will increase the intensity of the LEDs in audio synchronization mode.

The pole of the low pass filter band is set by the filter cap, Cfilt, and an internal 4kΩ resistor. The pole of the high pass filter band is internally set by programming the HPF\_F<1:0> bits of the Frequency Select Register. The midband frequency band is a function of the lowband and highband poles. The gain response of the midband frequency band can be set by programming the MGAIN<2:0> bits of the Gain Select Register.

### AUDIO SYNCHRONIZATION RANDOMIZER

The LM4970 features a randomizer block that randomizes the frequency band assigned to each PWM LED driver during audio synchronization operation. The randomizer is activated by setting the RAND bit in the Mode Select Register. Clearing the RAND bit will disable the randomizer. The randomizer can only be activated when the LM4970 is programmed to audio synchronization mode. The interval at which randomizer assigns a new frequency band is set to occur once every 3.2 seconds. The randomizer ensures that all the colored LEDs will light up over a long duration even if the audio input has a fixed frequency.

### I<sup>2</sup>C PATTERN MODE

The LM4970 features an I<sup>2</sup>C pattern mode for applications where direct control of the LED outputs is required. I<sup>2</sup>C pattern mode is activated by setting the I2C\_SEL bit in the Pattern Select Register. The LED1 output duty cycle can be programmed to 100% by setting the I2C\_LED1 bit in the Pattern Select Register. Clearing the I2C\_LED1 bit sets the LED1 output duty cycle to 0%. The LED2 output duty cycle can be programmed to 100% by setting the I2C\_LED2 bit in the Pattern Select Register. Clearing the I2C\_LED2 bit sets the LED2 output duty cycle to 0%. The LED3 output duty cycle can be programmed to 100% by setting the I2C\_LED3 bit in the Pattern Select Register. Clearing the I2C\_LED3 bit sets the LED3 output duty cycle to 0%. Color LEDs driven at 100% duty cycle are fully on, and driven at 0% duty cycle are fully off.

### PWM FREQUENCY

The PWM frequency of the color LED drivers is programmed through the PWM\_F<1:0> bits of the Frequency Select Register. The LM4970 features four different PWM frequency settings: 15kHz, 60Hz, 7Hz, and 4Hz. PWM frequency is analogous to the sampling rate of the audio input signal. A higher PWM frequency setting will result in a more accurate LED representation of the audio input signal in the audio synchronization mode. However, a PWM frequency that is set too high will decrease the ON time of the LED

## Application Information (Continued)

which will result in reduced LED intensity. A PWM frequency setting of 60Hz results in an optimal balance between LED accuracy and intensity.

### DRIVING RGB LED MODULES

The LM4970's PWM LED outputs can be used to drive individual color LEDs or RGB LED modules. When driving RGB LED modules in audio synchronization mode, the color

and intensity of the RGB LED module will be dependent on the audio input signal. In I<sup>2</sup>C pattern mode, the RGB LED module can be set to any of seven distinct colors, based on the status of the I2C\_LED1, I2C\_LED2, and I2C\_LED3 bit settings.

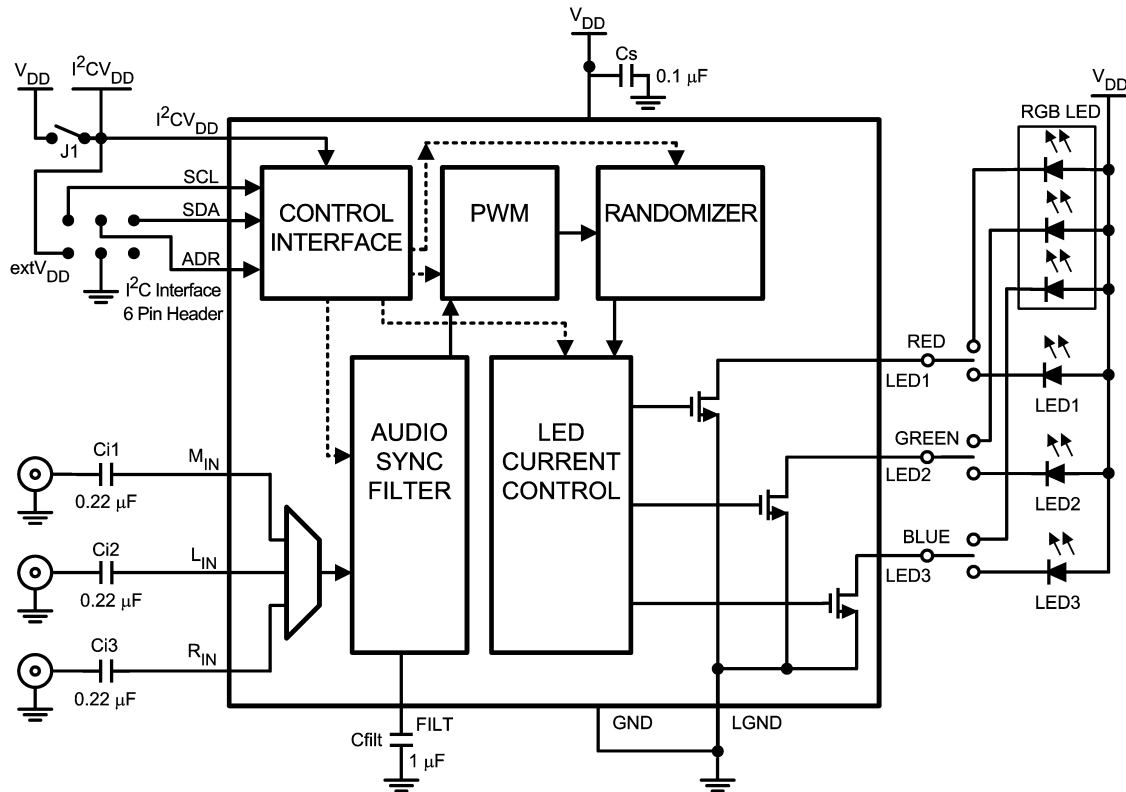

20121259

FIGURE 4. Reference Design Board Schematic

# Demonstration Board SD PCB Layout

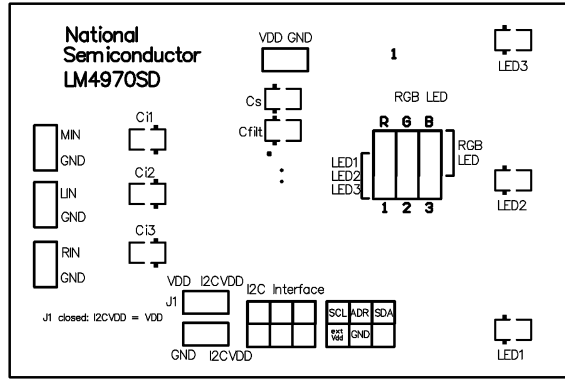

20121260

**Recommended SD PCB Layout:  
Top Silkscreen**

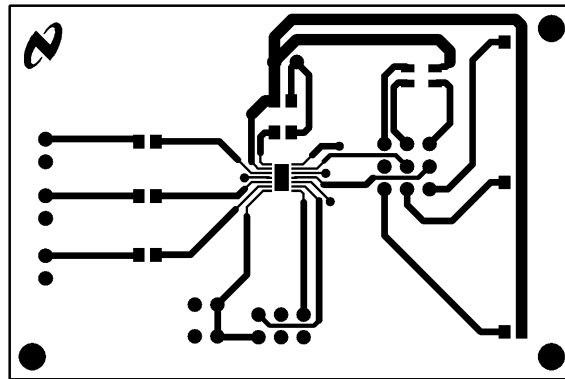

20121261

**Recommended SD PCB Layout:  
Top Layer**

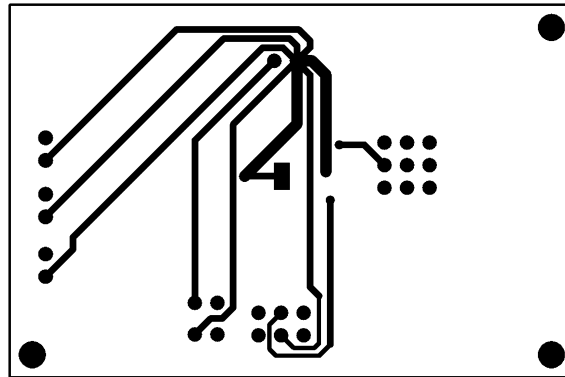

20121262

**Recommended SD PCB Layout:  
Bottom Layer**

**Physical Dimensions** inches (millimeters) unless otherwise noted

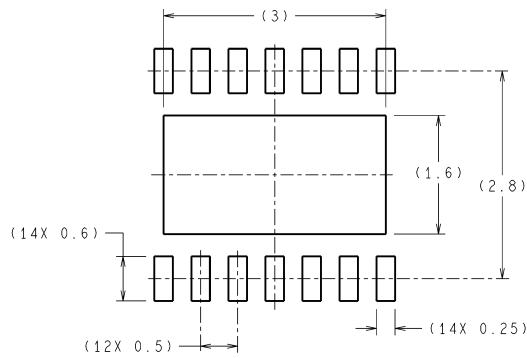

**RECOMMENDED LAND PATTERN**

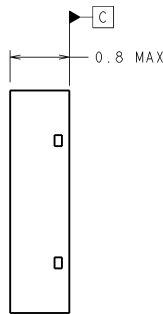
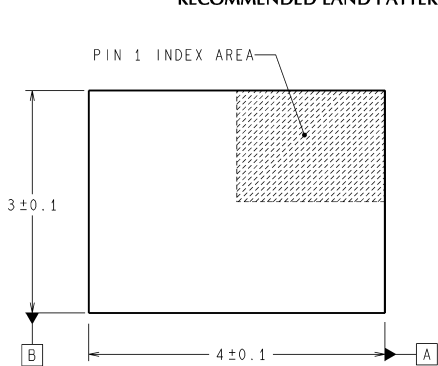

**DIMENSIONS ARE IN MILLIMETERS**  
DIMENSIONS IN ( ) FOR REFERENCE ONLY

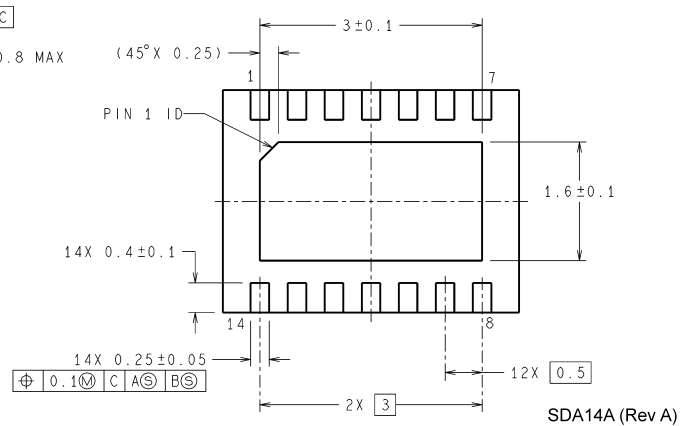
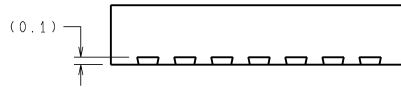

**14 pin SD Package**  
**Order Number LM4970SD**  
**NS Package Number SDA14A**

National does not assume any responsibility for use of any circuitry described, no circuit patent licenses are implied and National reserves the right at any time without notice to change said circuitry and specifications.

For the most current product information visit us at [www.national.com](http://www.national.com).

**LIFE SUPPORT POLICY**

NATIONAL'S PRODUCTS ARE NOT AUTHORIZED FOR USE AS CRITICAL COMPONENTS IN LIFE SUPPORT DEVICES OR SYSTEMS WITHOUT THE EXPRESS WRITTEN APPROVAL OF THE PRESIDENT AND GENERAL COUNSEL OF NATIONAL SEMICONDUCTOR CORPORATION. As used herein:

1. Life support devices or systems are devices or systems which, (a) are intended for surgical implant into the body, or (b) support or sustain life, and whose failure to perform when properly used in accordance with instructions for use provided in the labeling, can be reasonably expected to result in a significant injury to the user.
2. A critical component is any component of a life support device or system whose failure to perform can be reasonably expected to cause the failure of the life support device or system, or to affect its safety or effectiveness.

**BANNED SUBSTANCE COMPLIANCE**

National Semiconductor certifies that the products and packing materials meet the provisions of the Customer Products Stewardship Specification (CSP-9-111C2) and the Banned Substances and Materials of Interest Specification (CSP-9-111S2) and contain no "Banned Substances" as defined in CSP-9-111S2.



**National Semiconductor**  
**Americas Customer**  
**Support Center**  
Email: [new.feedback@nsc.com](mailto:new.feedback@nsc.com)  
Tel: 1-800-272-9959

**National Semiconductor**  
**Europe Customer Support Center**  
Fax: +49 (0) 180-530 85 86  
Email: [europe.support@nsc.com](mailto:europe.support@nsc.com)  
Deutsch Tel: +49 (0) 69 9508 6208  
English Tel: +44 (0) 870 24 0 2171  
Français Tel: +33 (0) 1 41 91 8790

**National Semiconductor**  
**Asia Pacific Customer**  
**Support Center**  
Email: [ap.support@nsc.com](mailto:ap.support@nsc.com)

**National Semiconductor**  
**Japan Customer Support Center**  
Fax: 81-3-5639-7507  
Email: [jpn.feedback@nsc.com](mailto:jpn.feedback@nsc.com)  
Tel: 81-3-5639-7560