



February 1984  
Revised October 1999

## MM74HC4049 • MM74HC4050

### Hex Inverting Logic Level Down Converter • Hex Logic Level Down Converter

#### General Description

The MM74HC4049 and the MM74HC4050 utilize advanced silicon-gate CMOS technology, and have a modified input protection structure that enables these parts to be used as logic level translators which will convert high level logic to a low level logic while operating from the low logic supply. For example, 0–15V CMOS logic can be converted to 0–5V logic when using a 5V supply. The modified input protection has no diode connected to  $V_{CC}$ , thus allowing the input voltage to exceed the supply. The lower zener diode protects the input from both positive and negative static voltages. In addition each part can be used as a sim-

ple buffer or inverter without level translation. The MM74HC4049 is pin and functionally compatible to the CD4049BC and the MM74HC4050 is compatible to the CD4050BC

#### Features

- Typical propagation delay: 8 ns
- Wide power supply range: 2V–6V
- Low quiescent supply current: 20  $\mu$ A maximum (74HC)
- Fanout of 10 LS-TTL loads

#### Ordering Code:

Order Number	Package Number	Package Description
MM74HC4049M	M16A	16-Lead Small Outline Integrated Circuit (SOIC), JEDEC MS-012, 0.150" Narrow
MM74HC4049SJ	M16D	16-Lead Small Outline Package (SOP), EIAJ TYPE II, 5.3mm Wide
MM74HC4049MTC	MTC16	16-Lead Thin Shrink Small Outline Package (TSSOP), JEDEC MO-153, 4.4mm Wide
MM74HC4049N	N16E	16-Lead Plastic Dual-In-Line Package (PDIP), JEDEC MS-001, 0.300" Wide
MM74HC4050M	M16A	16-Lead Small Outline Integrated Circuit (SOIC), JEDEC MS-012, 0.150" Narrow
MM74HC4050SJ	M16D	16-Lead Small Outline Package (SOP), EIAJ TYPE II, 5.3mm Wide
MM74HC4050MTC	MTC16	16-Lead Thin Shrink Small Outline Package (TSSOP), JEDEC MO-153, 4.4mm Wide
MM74HC4050N	N16E	16-Lead Plastic Dual-In-Line Package (PDIP), JEDEC MS-001, 0.300" Wide

Devices also available in Tape and Reel. Specify by appending the suffix letter "X" to the ordering code.

#### Connection Diagrams

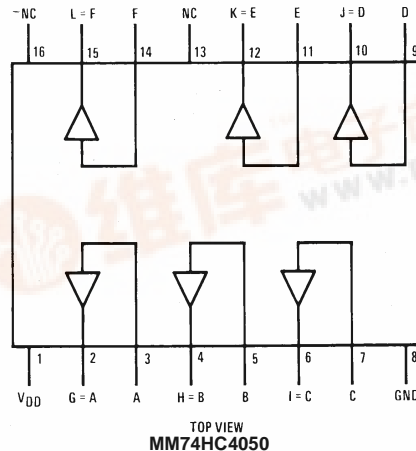
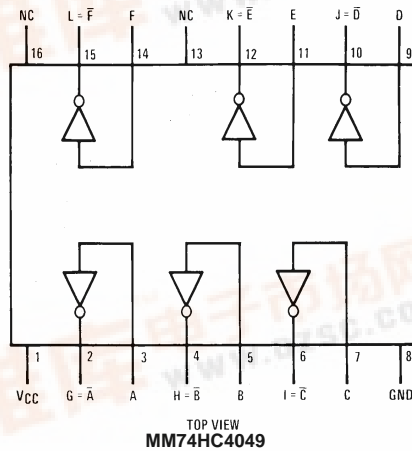

MM74HC4049 • MM74HC4050 Hex Inverting Logic Level Down Converter • Hex Logic Level Down Converter



**Absolute Maximum Ratings** (Note 1)

(Note 2)

Supply Voltage ( $V_{CC}$ )	-0.5 to +7.0V
DC Input Voltage ( $V_{IN}$ )	-1.5 to +18V
DC Output Voltage ( $V_{OUT}$ )	-0.5 to $V_{CC}+0.5V$
Clamp Diode Current ( $I_{ZK}, I_{OK}$ )	-20 mA
DC Output Current, per pin ( $I_{OUT}$ )	$\pm 25$ mA
DC $V_{CC}$ or GND Current, per pin ( $I_{CC}$ )	$\pm 50$ mA
Storage Temperature Range ( $T_{STG}$ )	-65°C to +150°C
Power Dissipation ( $P_D$ )	
(Note 3)	600 mW
S.O. Package only	500 mW
Lead Temperature ( $T_L$ )	
(Soldering 10 seconds)	260°C

**Recommended Operating Conditions**

	Min	Max	Units
Supply Voltage ( $V_{CC}$ )	2	6	V
DC Input Voltage ( $V_{IN}$ )	0	15	V
DC Output Voltage ( $V_{OUT}$ )	0	$V_{CC}$	V
Operating Temperature Range ( $T_A$ )	-40	+85	°C
Input Rise or Fall Times ( $t_r, t_f$ )			
$V_{CC} = 2.0V$		1000	ns
$V_{CC} = 4.5V$		500	ns
$V_{CC} = 6.0V$		400	ns

**Note 1:** Absolute Maximum Ratings are those values beyond which damage to the device may occur.

**Note 2:** Unless otherwise specified all voltages are referenced to ground.

**Note 3:** Power Dissipation temperature derating — plastic "N" package: — 12 mW/°C from 65°C to 85°C.

**DC Electrical Characteristics** (Note 4)

Symbol	Parameter	Conditions	$V_{CC}$	$T_A = 25^\circ\text{C}$			Units	
				Typ	Guaranteed Limits			
$V_{IH}$	Minimum HIGH Level Input Voltage		2.0V		1.5	1.5	V	
			4.5V		3.15	3.15	V	
			6.0V		4.2	4.2	V	
$V_{IL}$	Maximum LOW Level Input Voltage		2.0V		0.5	0.5	V	
			4.5V		1.35	1.35	V	
			6.0V		1.8	1.8	V	
$V_{OH}$	Minimum HIGH Level Output Voltage	$V_{IN} = V_{IH}$ or $V_{IL}$ $ I_{OUT}  \leq 20 \mu\text{A}$	2.0V	2.0	1.9	1.9	V	
			4.5V	4.5	4.4	4.4	V	
			6.0V	6.0	5.9	5.9	V	
		$V_{IN} = V_{IH}$ or $V_{IL}$ $ I_{OUT}  \leq 4.0 \text{ mA}$ $ I_{OUT}  \leq 5.2 \text{ mA}$	4.5V	4.2	3.98	3.84	3.7	V
			6.0V	5.7	5.48	5.34	5.2	V
$V_{OL}$	Maximum LOW Level Output Voltage	$V_{IN} = V_{IH}$ or $V_{IL}$ $ I_{OUT}  \leq 20 \mu\text{A}$	2.0V	0	0.1	0.1	V	
			4.5V	0	0.1	0.1	V	
			6.0V	0	0.1	0.1	V	
		$V_{IN} = V_{IH}$ or $V_{IL}$ $ I_{OUT}  \leq 4 \text{ mA}$ $ I_{OUT}  \leq 5.2 \text{ mA}$	4.5V	0.2	0.26	0.33	0.4	V
			6.0V	0.2	0.26	0.33	0.4	V
$I_{IN}$	Maximum Input Current	$V_{IN} = V_{CC}$ or GND	6.0V		$\pm 0.1$	$\pm 1.0$	$\mu\text{A}$	
		$V_{IN} = 15V$	2.0V		$\pm 0.5$	$\pm 5$	$\mu\text{A}$	
$I_{CC}$	Maximum Quiescent Supply Current	$V_{IN} = V_{CC}$ or GND $I_{OUT} = 0 \mu\text{A}$	6.0V		2.0	20	$\mu\text{A}$	

**Note 4:** For a power supply of 5V  $\pm 10\%$  the worst case output voltages ( $V_{OH}$  and  $V_{OL}$ ) occur for HC at 4.5V. Thus the 4.5V values should be used when designing with this supply. Worst case  $V_{IH}$  and  $V_{IL}$  occur at  $V_{CC} = 5.5V$  and 4.5V respectively. (The  $V_{IH}$  value at 5.5V is 3.85V.) The worst case leakage current ( $I_{IN}$ ,  $I_{CC}$ ,  $I_{OZ}$ ) occur for CMOS at the higher voltage and so the 6.0V values should be used.

**AC Electrical Characteristics** $V_{CC} = 5V$ ,  $T_A = 25^\circ C$ ,  $C_L = 15$  pF,  $t_r = t_f = 6$  ns

Symbol	Parameter	Conditions	Typ	Guaranteed Limit	Units
$t_{PHL}$ , $t_{PLH}$	Maximum Propagation Delay		8	15	ns

**AC Electrical Characteristics** $V_{CC} = 2.0V$  to  $6.0V$ ,  $C_L = 50$  pF,  $t_r = t_f = 6$  ns (unless otherwise specified)

Symbol	Parameter	Conditions	$V_{CC}$	$T_A = 25^\circ C$		$T_A = -40^\circ$ to $85^\circ C$	$T_A = -55^\circ$ to $125^\circ C$	Units
				Typ	Guaranteed Limits			
$t_{PHL}$ , $t_{PLH}$	Maximum Propagation Delay		2.0V	30	85	100	130	ns
			4.5V	10	17	20	26	ns
			6.0V	9	15	18	22	ns
$t_{THL}$ , $t_{TLH}$	Maximum Output Rise and Fall Time		2.0V	25	75	95	110	ns
			4.5V	7	15	19	22	ns
			6.0V	6	13	16	19	ns
$C_{PD}$	Power Dissipation Capacitance (Note 5)	(per gate)		25				pF
$C_{IN}$	Maximum Input Capacitance			5	10	10	10	pF

**Note 5:**  $C_{PD}$  determines the no load dynamic power consumption,  $P_D = C_{PD} V_{CC}^2 f + I_{CC} V_{CC}$ , and the no load dynamic current consumption,  $I_S = C_{PD} V_{CC} f + I_{CC}$ .

**Physical Dimensions** inches (millimeters) unless otherwise noted

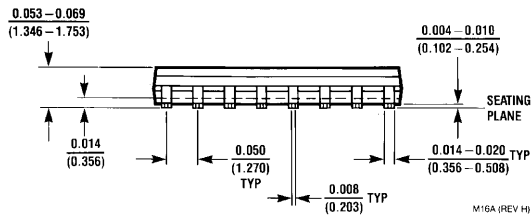
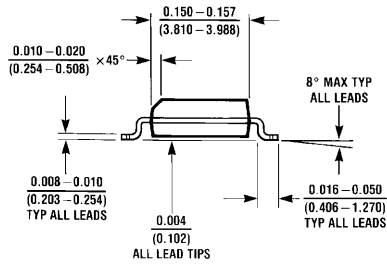
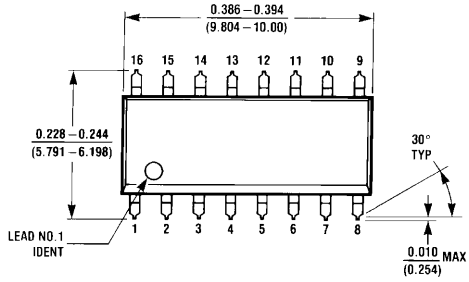

**16-Lead Small Outline Integrated Circuit (SOIC), JEDEC MS-012, 0.150" Narrow  
Package Number M16A**

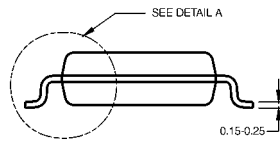
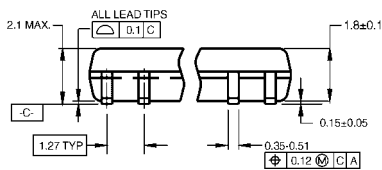
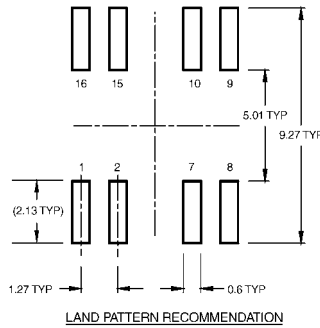
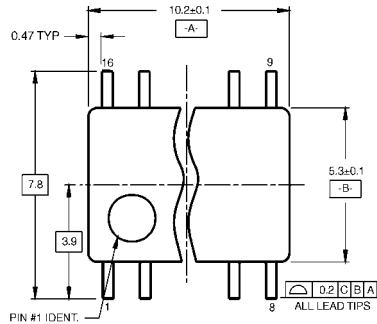

DIMENSIONS ARE IN MILLIMETERS

**16-Lead Small Outline Package (SOP), EIAJ TYPE II, 5.3mm Wide  
Package Number M16D**

**Physical Dimensions** inches (millimeters) unless otherwise noted (Continued)

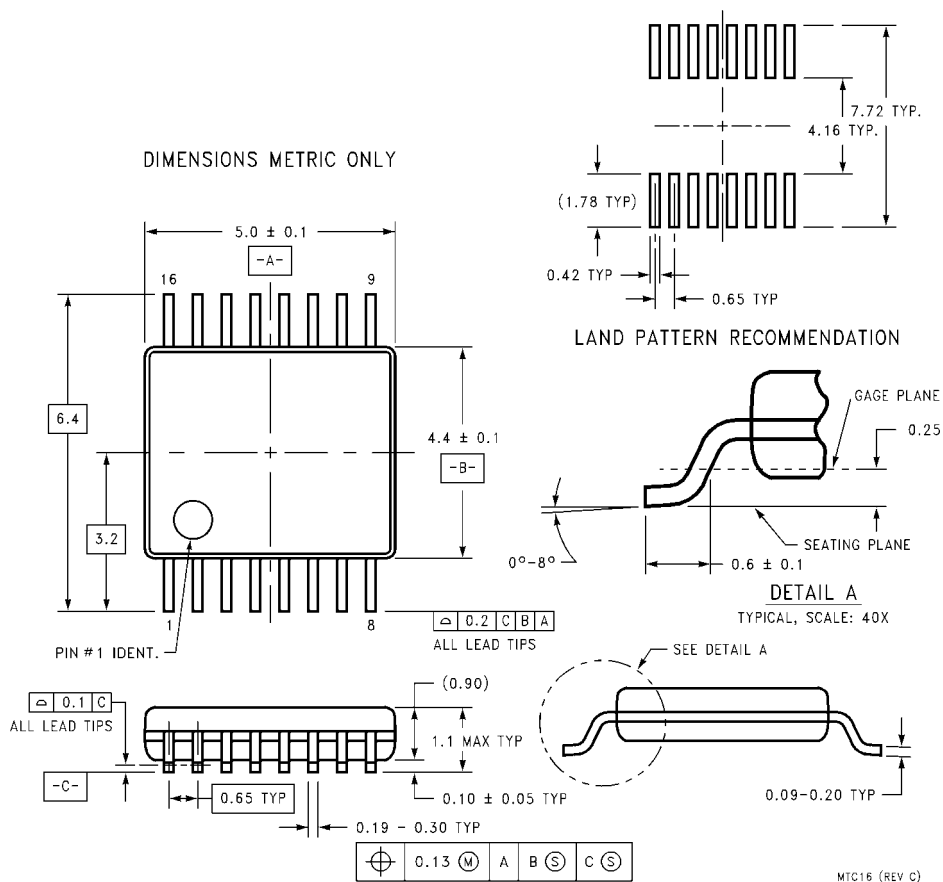

**16-Lead Thin Shrink Small Outline Package (TSSOP), JEDEC MO-153, 4.4mm Wide  
Package Number MTC16**

MTC16 (REV C)

**Physical Dimensions** inches (millimeters) unless otherwise noted (Continued)

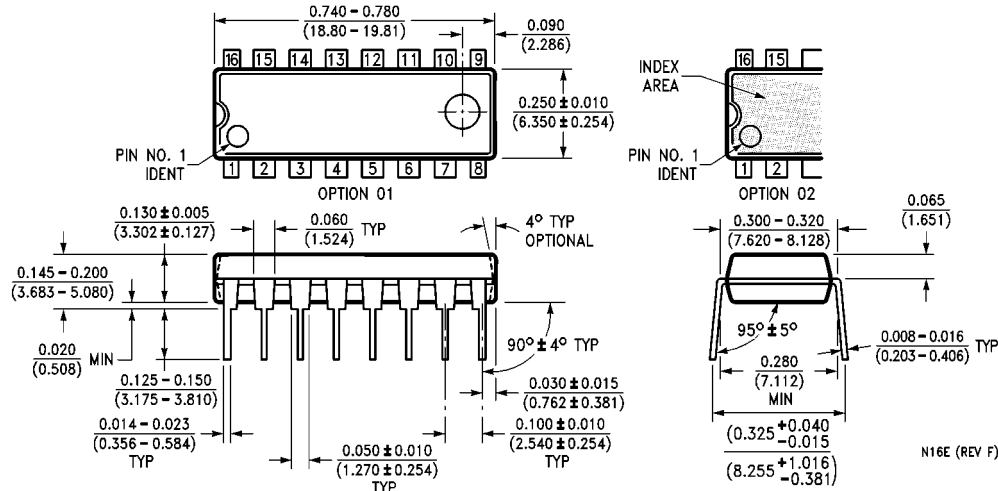

**16-Lead Plastic Dual-In-Line Package (PDIP), JEDEC MS-001, 0.300" Wide  
Package Number N16E**

Fairchild does not assume any responsibility for use of any circuitry described, no circuit patent licenses are implied and Fairchild reserves the right at any time without notice to change said circuitry and specifications.

**LIFE SUPPORT POLICY**

FAIRCHILD'S PRODUCTS ARE NOT AUTHORIZED FOR USE AS CRITICAL COMPONENTS IN LIFE SUPPORT DEVICES OR SYSTEMS WITHOUT THE EXPRESS WRITTEN APPROVAL OF THE PRESIDENT OF FAIRCHILD SEMICONDUCTOR CORPORATION. As used herein:

1. Life support devices or systems are devices or systems which, (a) are intended for surgical implant into the body, or (b) support or sustain life, and (c) whose failure to perform when properly used in accordance with instructions for use provided in the labeling, can be reasonably expected to result in a significant injury to the user.
2. A critical component in any component of a life support device or system whose failure to perform can be reasonably expected to cause the failure of the life support device or system, or to affect its safety or effectiveness.

[www.fairchildsemi.com](http://www.fairchildsemi.com)