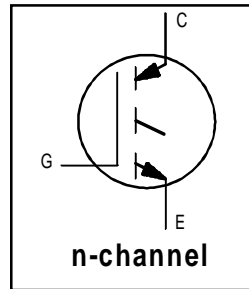


# IRG4BC20W

INSULATED GATE BIPOLAR TRANSISTOR

## Features

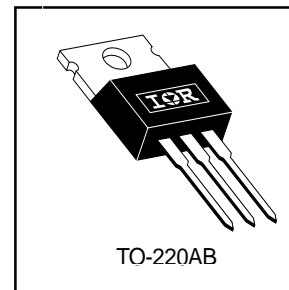
- Designed expressly for Switch-Mode Power Supply and PFC (power factor correction) applications
- Industry-benchmark switching losses improve efficiency of all power supply topologies
- 50% reduction of Eoff parameter
- Low IGBT conduction losses
- Latest-generation IGBT design and construction offers tighter parameters distribution, exceptional reliability



$V_{CES} = 600V$
$V_{CE(on)} \text{ typ.} = 2.16V$
@ $V_{GE} = 15V, I_C = 6.5A$

## Benefits

- Lower switching losses allow more cost-effective operation than power MOSFETs up to 150 kHz ("hard switched" mode)
- Of particular benefit to single-ended converters and boost PFC topologies 150W and higher
- Low conduction losses and minimal minority-carrier recombination make these an excellent option for resonant mode switching as well (up to >>300 kHz)



## Absolute Maximum Ratings

	Parameter	Max.	Units
$V_{CES}$	Collector-to-Emitter Breakdown Voltage	600	V
$I_C @ T_C = 25^\circ C$	Continuous Collector Current	13	A
$I_C @ T_C = 100^\circ C$	Continuous Collector Current	6.5	
$I_{CM}$	Pulsed Collector Current ①	52	
$I_{LM}$	Clamped Inductive Load Current ②	52	
$V_{GE}$	Gate-to-Emitter Voltage	$\pm 20$	V
$E_{ARV}$	Reverse Voltage Avalanche Energy ③	200	mJ
$P_D @ T_C = 25^\circ C$	Maximum Power Dissipation	60	W
$P_D @ T_C = 100^\circ C$	Maximum Power Dissipation	24	
$T_J$	Operating Junction and	-55 to + 150	°C
$T_{STG}$	Storage Temperature Range		
	Soldering Temperature, for 10 seconds	300 (0.063 in. (1.6mm) from case )	
	Mounting torque, 6-32 or M3 screw.	10 lbf•in (1.1N•m)	

## Thermal Resistance

	Parameter	Typ.	Max.	Units
$R_{\theta JC}$	Junction-to-Case	—	2.1	°C/W
$R_{\theta CS}$	Case-to-Sink, Flat, Greased Surface	0.5	—	
$R_{\theta JA}$	Junction-to-Ambient, typical socket mount	—	80	
Wt	Weight	2.0 (0.07)	—	g (oz)

# IRG4BC20W

## Electrical Characteristics @ $T_J = 25^\circ\text{C}$ (unless otherwise specified)

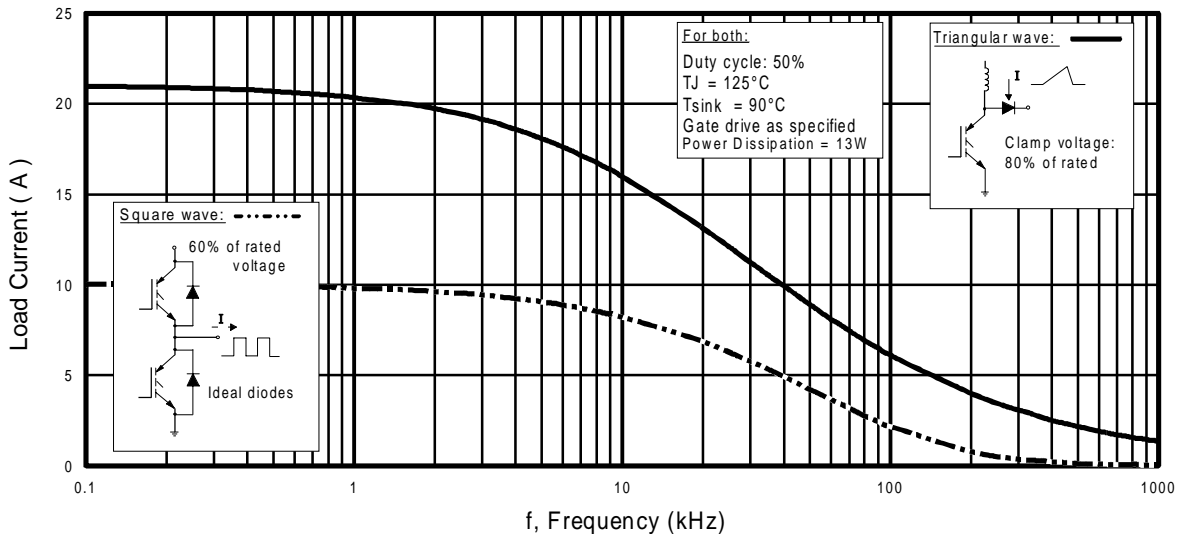
	Parameter	Min.	Typ.	Max.	Units	Conditions
$V_{(BR)CES}$	Collector-to-Emitter Breakdown Voltage	600	—	—	V	$V_{GE} = 0V, I_C = 250\mu A$
$V_{(BR)ECS}$	Emitter-to-Collector Breakdown Voltage ④	18	—	—	V	$V_{GE} = 0V, I_C = 1.0A$
$\Delta V_{(BR)CES}/\Delta T_J$	Temperature Coeff. of Breakdown Voltage	—	0.48	—	V/°C	$V_{GE} = 0V, I_C = 1.0mA$
$V_{CE(ON)}$	Collector-to-Emitter Saturation Voltage	—	2.16	2.6	V	$I_C = 6.5A$ $I_C = 13A$ $I_C = 6.5A, T_J = 150^\circ\text{C}$ $V_{GE} = 15V$ See Fig.2, 5
		—	2.55	—		
		—	2.05	—		
$V_{GE(th)}$	Gate Threshold Voltage	3.0	—	6.0		$V_{CE} = V_{GE}, I_C = 250\mu A$
$\Delta V_{GE(th)}/\Delta T_J$	Temperature Coeff. of Threshold Voltage	—	-8.8	—	mV/°C	$V_{CE} = V_{GE}, I_C = 250\mu A$
$g_{fe}$	Forward Transconductance ⑤	5.5	8.3	—	S	$V_{CE} = 100V, I_C = 6.5A$
$I_{CES}$	Zero Gate Voltage Collector Current	—	—	250	$\mu A$	$V_{GE} = 0V, V_{CE} = 600V$
		—	—	2.0		$V_{GE} = 0V, V_{CE} = 10V, T_J = 25^\circ\text{C}$
		—	—	1000		$V_{GE} = 0V, V_{CE} = 600V, T_J = 150^\circ\text{C}$
$I_{GES}$	Gate-to-Emitter Leakage Current	—	—	$\pm 100$	nA	$V_{GE} = \pm 20V$

## Switching Characteristics @ $T_J = 25^\circ\text{C}$ (unless otherwise specified)

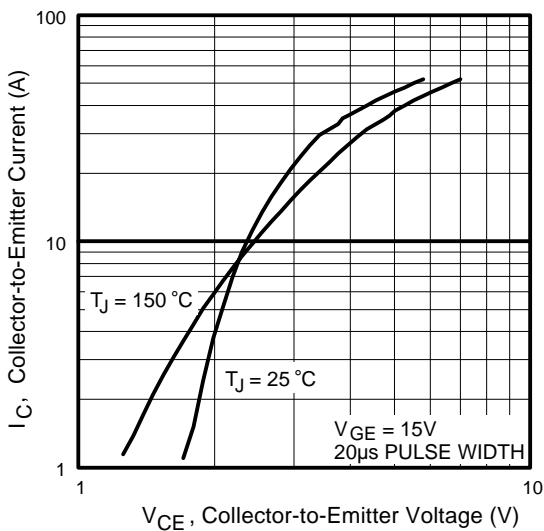
	Parameter	Min.	Typ.	Max.	Units	Conditions
$Q_g$	Total Gate Charge (turn-on)	—	26	38	nC	$I_C = 6.5A$ $V_{CC} = 400V$ $V_{GE} = 15V$ See Fig.8
$Q_{ge}$	Gate - Emitter Charge (turn-on)	—	3.7	5.5		
$Q_{gc}$	Gate - Collector Charge (turn-on)	—	10	15		
$t_{d(on)}$	Turn-On Delay Time	—	22	—	ns	$T_J = 25^\circ\text{C}$ $I_C = 6.5A, V_{CC} = 480V$ $V_{GE} = 15V, R_G = 50\Omega$ Energy losses include "tail" See Fig. 9, 10, 14
$t_r$	Rise Time	—	14	—		
$t_{d(off)}$	Turn-Off Delay Time	—	110	160		
$t_f$	Fall Time	—	64	96		
$E_{on}$	Turn-On Switching Loss	—	0.06	—	mJ	See Fig. 9, 10, 14
$E_{off}$	Turn-Off Switching Loss	—	0.08	—		
$E_{ts}$	Total Switching Loss	—	0.14	0.2	ns	$T_J = 150^\circ\text{C},$ $I_C = 6.5A, V_{CC} = 480V$ $V_{GE} = 15V, R_G = 50\Omega$ Energy losses include "tail" See Fig. 10, 11, 14
$t_{d(on)}$	Turn-On Delay Time	—	21	—		
$t_r$	Rise Time	—	15	—		
$t_{d(off)}$	Turn-Off Delay Time	—	150	—		
$t_f$	Fall Time	—	150	—	mJ	See Fig. 10, 11, 14
$E_{ts}$	Total Switching Loss	—	0.34	—		
$L_E$	Internal Emitter Inductance	—	7.5	—	nH	Measured 5mm from package
$C_{ies}$	Input Capacitance	—	490	—	pF	$V_{GE} = 0V$ $V_{CC} = 30V$ $f = 1.0MHz$ See Fig. 7
$C_{oes}$	Output Capacitance	—	38	—		
$C_{res}$	Reverse Transfer Capacitance	—	8.8	—		

### Notes:

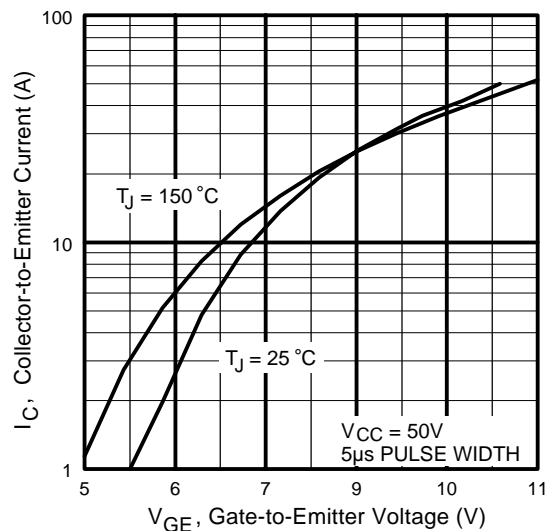
- ① Repetitive rating;  $V_{GE} = 20V$ , pulse width limited by max. junction temperature. ( See fig. 13b )
- ②  $V_{CC} = 80\%(V_{CES}), V_{GE} = 20V, L = 10\mu H, R_G = 50\Omega,$   
(See fig. 13a)
- ③ Repetitive rating; pulse width limited by maximum junction temperature.
- ④ Pulse width  $\leq 80\mu s$ ; duty factor  $\leq 0.1\%$ .
- ⑤ Pulse width  $5.0\mu s$ , single shot.



**Fig. 1 - Typical Load Current vs. Frequency**  
(Load Current =  $I_{RMS}$  of fundamental)

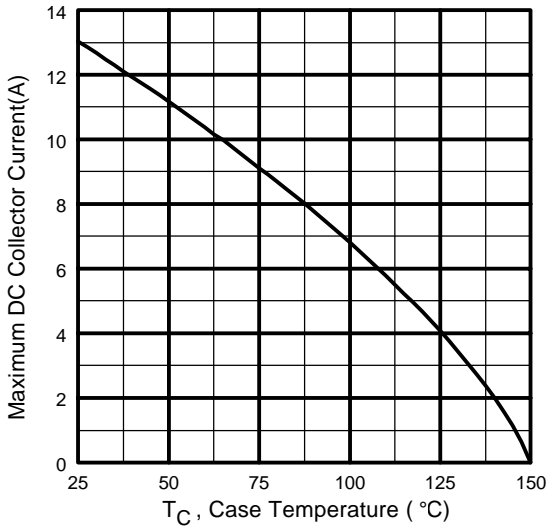


**Fig. 2 - Typical Output Characteristics**

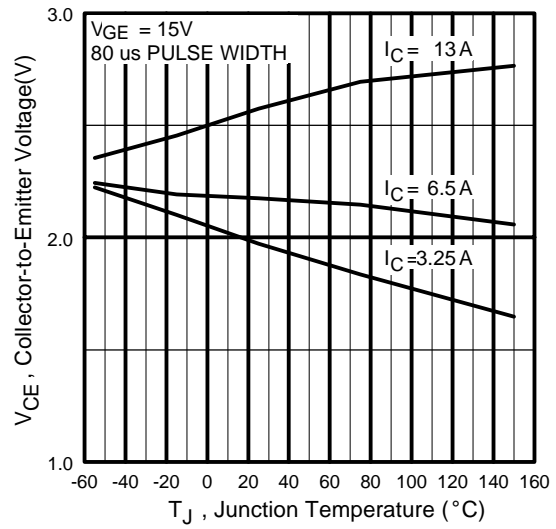


**Fig. 3 - Typical Transfer Characteristics**

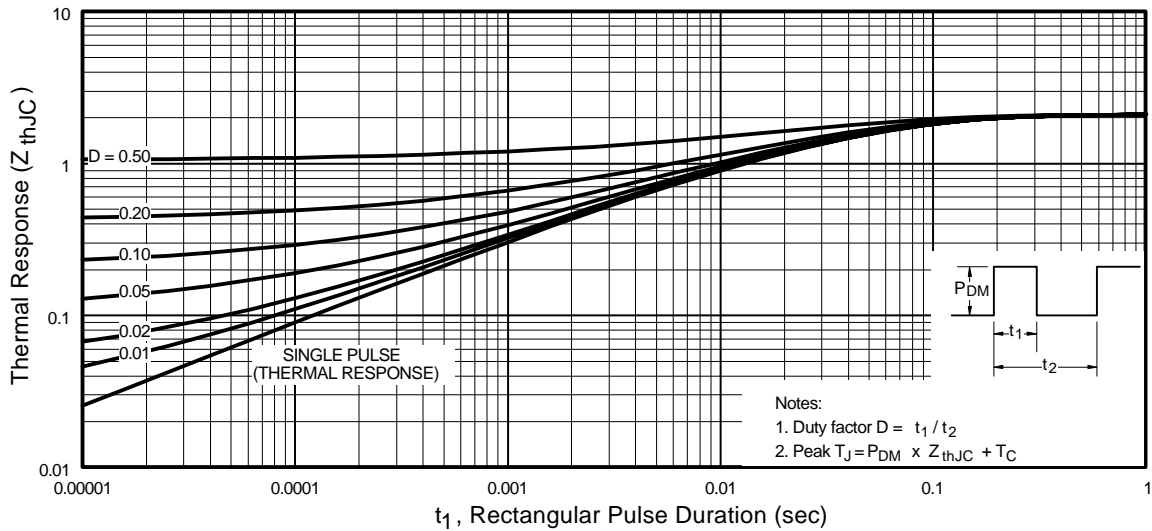
# IRG4BC20W



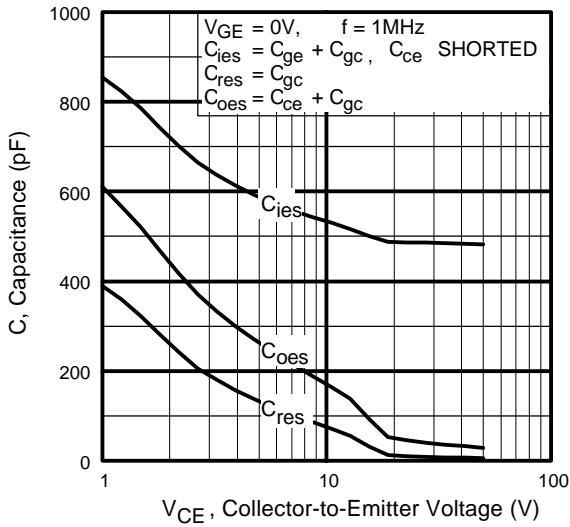
**Fig. 4** - Maximum Collector Current vs. Case Temperature



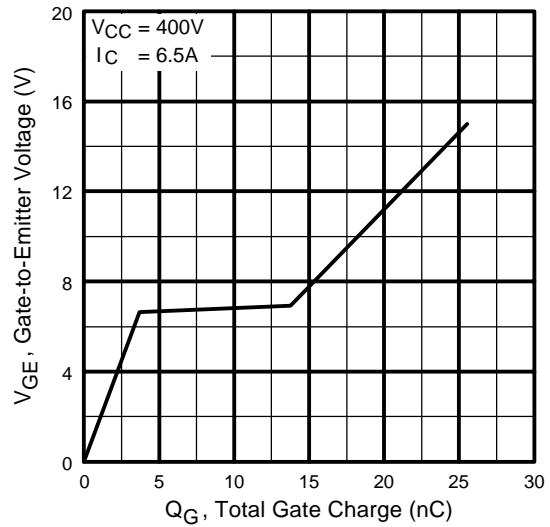
**Fig. 5** - Typical Collector-to-Emitter Voltage vs. Junction Temperature



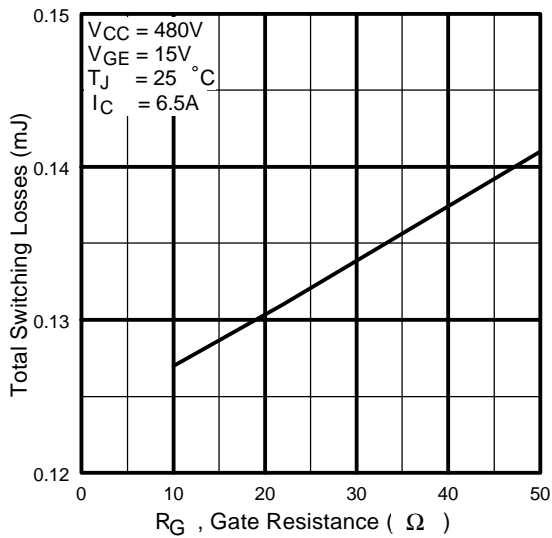
**Fig. 6** - Maximum Effective Transient Thermal Impedance, Junction-to-Case



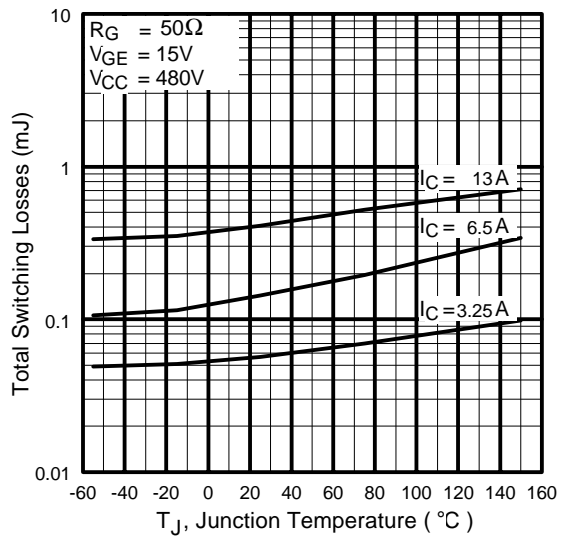
**Fig. 7** - Typical Capacitance vs. Collector-to-Emitter Voltage



**Fig. 8** - Typical Gate Charge vs. Gate-to-Emitter Voltage

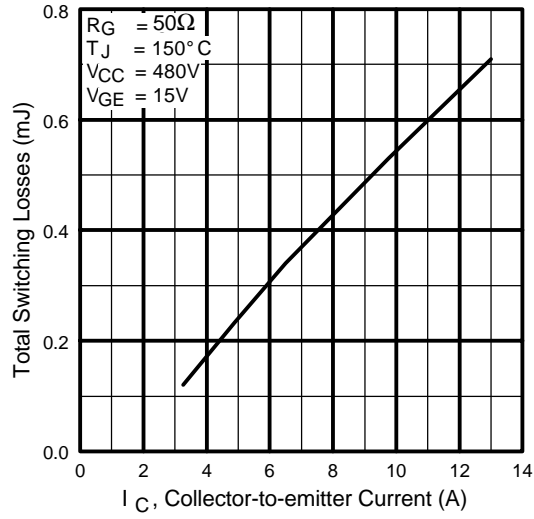


**Fig. 9** - Typical Switching Losses vs. Gate Resistance

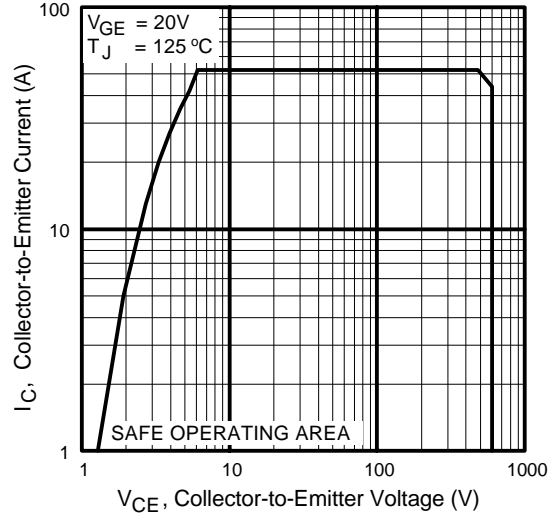


**Fig. 10** - Typical Switching Losses vs. Junction Temperature

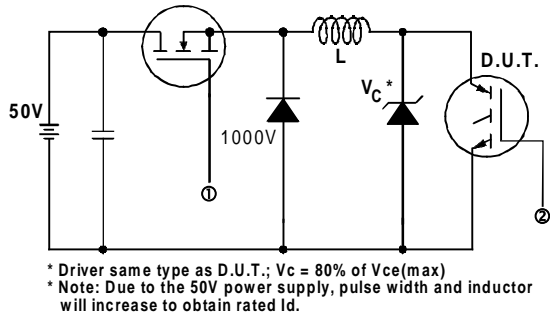
# IRG4BC20W



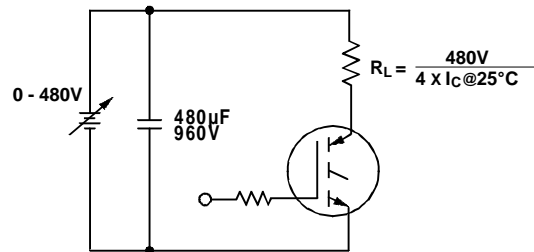
**Fig. 11** - Typical Switching Losses vs. Collector-to-Emitter Current



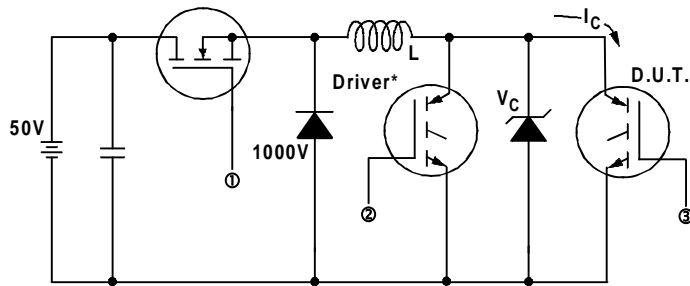
**Fig. 12** - Turn-Off SOA



**Fig. 13a - Clamped Inductive Load Test Circuit**

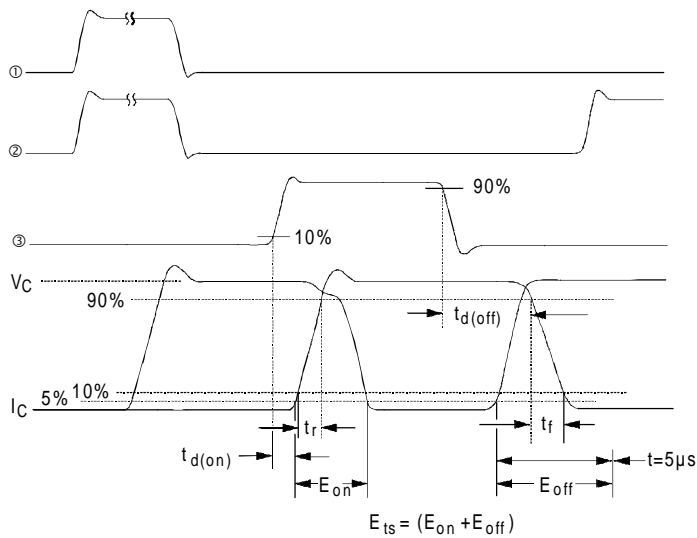


**Fig. 13b - Pulsed Collector Current Test Circuit**



**Fig. 14a - Switching Loss Test Circuit**

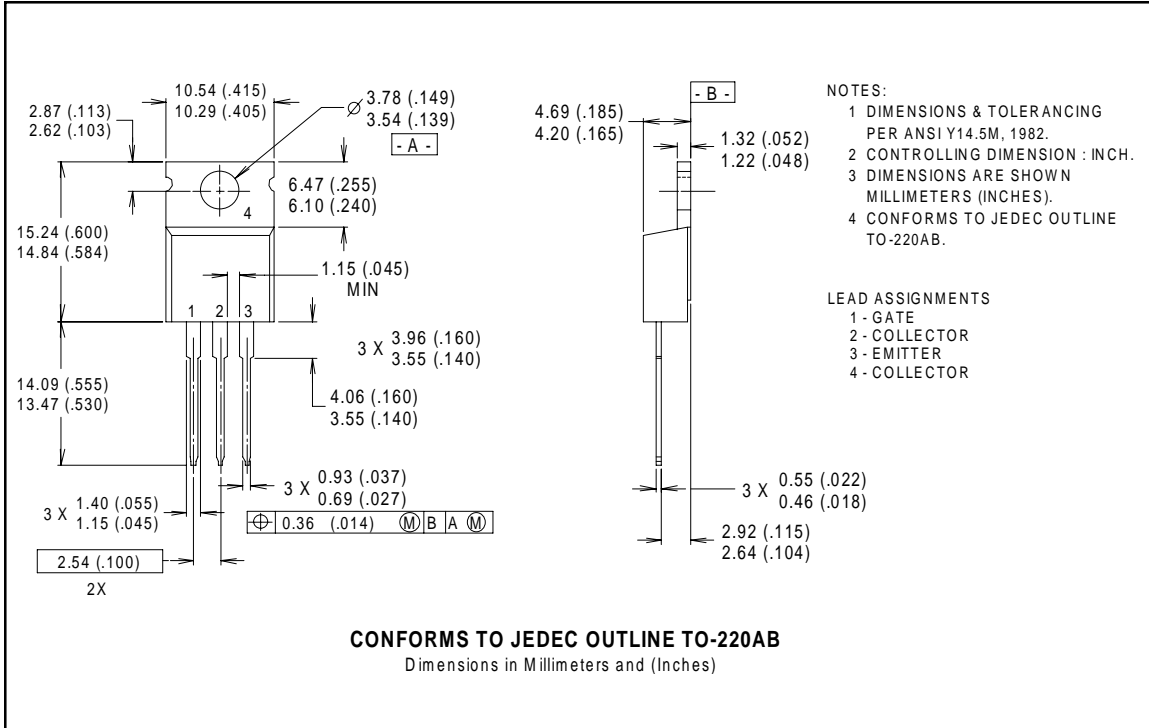
\* Driver same type as D.U.T., VC = 480V



**Fig. 14b - Switching Loss Waveforms**

# IRG4BC20W

## Case Outline and Dimensions — TO-220AB





Copyright © Each Manufacturing Company.

All Datasheets cannot be modified without permission.

This datasheet has been download from :

[www.AllDataSheet.com](http://www.AllDataSheet.com)

100% Free DataSheet Search Site.

Free Download.

No Register.

Fast Search System.

[www.AllDataSheet.com](http://www.AllDataSheet.com)