

DS14C241 Single Supply TIA/EIA-232 4 x 5 Driver/Receiver

General Description

The DS14C241 is four driver, five receiver device which conforms to the TIA/EIA-232-E standard and CCITT V.28 recommendations. This device eliminates $\pm 12V$ supplies by employing an internal DC-DC converter to generate the necessary output levels from a single +5V supply. Driver slew rate control and receiver noise filtering have also been internalized to eliminate the need for external slew rate control and noise filtering capacitors. With the addition of TRI-STATE[®] receiver outputs and a shutdown mode, device power consumption is kept to a minimum.

Features

- Conforms to TIA/EIA-232-E and CCITT V.28
- Internal DC-DC converter
- Operates with single +5V supply
- Low power requirement— I_{CC} 10 mA max
- Shutdown mode— I_{CX} 10 μA max
- Internal driver slew rate control
- Receiver noise filtering
- Operates above 120 kbits/sec
- TRI-STATE receiver outputs
- Direct replacement for MAX241

Connection Diagram

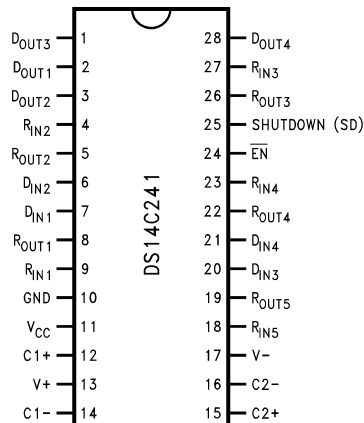

DS011281-1

Order Number DS14C241WM
See NS Package Number M28B

Functional Diagram

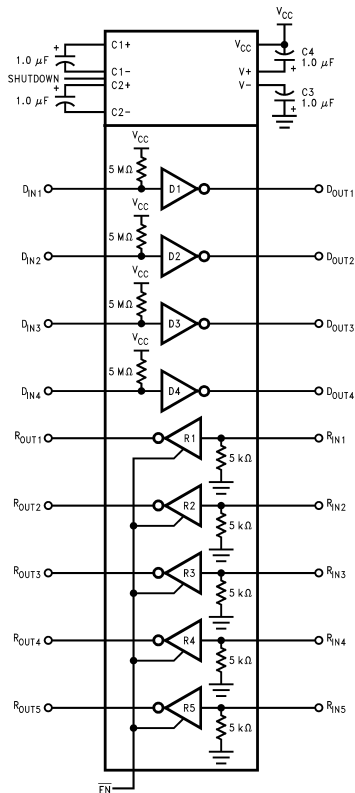

DS011281-2

TRI-STATE[®] is a registered trademark of National Semiconductor Corporation.

Absolute Maximum Ratings (Note 1)

If Military/Aerospace specified devices are required, please contact the National Semiconductor Sales Office/Distributors for availability and specifications.

Supply Voltage (V_{CC})	-0.3V to +6V
V^+ Pin	($V_{CC} - 0.3V$) to +15V
V^- Pin	+0.3V to -15V
Driver Input Voltage	-0.3V to ($V_{CC} + 0.3V$)
Driver Output Voltage	($V^+ + 0.3V$) to ($V^- - 0.3V$)
Receiver Input Voltage	$\pm 30V$
Receiver Output Voltage	-0.3V to ($V_{CC} + 0.3V$)
Junction Temperature	+150°C
Maximum Package Power Dissipation @ +25°C (Note 6)	
WM Package	1520 mW

Storage Temperature Range	-65°C to +150°C
Lead Temperature (Soldering, 4 sec.)	+260°C
Short Circuit Duration (D_{OUT})	continuous
ESD Rating (HBM, 1.5 k Ω , 100 pF)	≥ 2.0 kV

Recommended Operating Conditions

	Min	Max	Units
Supply Voltage (V_{CC})	4.5	5.5	V
Operating Free Air Temp. (T_A) DS14C241	0	+70	°C

Electrical Characteristics (Note 2)

Over recommended operating conditions, unless otherwise specified

Symbol	Parameter	Conditions	Min	Typ	Max	Units	
DEVICE CHARACTERISTICS							
V^+	Positive Power Supply	$R_L = 3$ k Ω , C1-C4 = 1.0 μ F, $D_{IN} = 0.8V$		9.0		V	
V^-	Negative Power Supply	$R_L = 3$ k Ω , C1-C4 = 1.0 μ F, $D_{IN} = 2.0V$		-8.0		V	
I_{CC}	Supply Current (V_{CC})	No Load		8.5	10	mA	
I_{CX}	Supply Current Shutdown	$R_L = 3$ k Ω , SD = V_{CC}		1.0	10	μ A	
V_{IH}	High Level Enable Voltage	SD	2.4		V_{CC}	V	
V_{IL}	Low Level Enable Voltage		GND		0.8	V	
I_{IH}	High Level Enable Current		-10		+10	μ A	
I_{IL}	Low Level Enable Current		-10		+10	μ A	
DRIVER CHARACTERISTICS							
V_{IH}	High Level Input Voltage	D_{IN}	2.0		V_{CC}	V	
V_{IL}	Low Level Input Voltage		GND		0.8	V	
I_{IH}	High Level Input Current		$V_{IN} \geq 2.0V$	-10		+10	μ A
I_{IL}	Low Level Input Current		$V_{IN} \leq 0.8V$	-10		+10	μ A
V_{OH}	High Level Output Voltage	$R_L = 3$ k Ω	5.0	7.5		V	
V_{OL}	Low Level Output Voltage				-6.5	-5.0	V
I_{OS+}	Output High Short Circuit Current	$V_O = 0V$, $V_{IN} = 0.8V$	-30	-15	-5.0	mA	
I_{OS-}	Output Low Short Circuit Current	$V_O = 0V$, $V_{IN} = 2.0V$	5.0	12	30	mA	
R_O	Output Resistance	$-2V \leq V_O \leq +2V$, $V_{CC} = GND = 0V$	300			Ω	
RECEIVER CHARACTERISTICS							
V_{TH}	Input High Threshold Voltage			1.9	2.4	V	
V_{TL}	Input Low Threshold Voltage		0.8	1.5		V	
V_{HY}	Hysteresis		0.2	0.4	1.0	V	
R_{IN}	Input Resistance		3.0	4.5	7.0	k Ω	
I_{IN}	Input Current	$V_{IN} = +15V$	2.14	3.8	5.0	mA	
		$V_{IN} = +3V$	0.43	0.6	1.0	mA	
		$V_{IN} = -3V$	-1.0	-0.6	-0.43	mA	
		$V_{IN} = -15V$	-5.0	-3.8	-2.14	mA	
V_{OH}	High Level Output Voltage	$V_{IN} = -3V$, $I_O = -3.2$ mA	3.5	4.6		V	
		$V_{IN} = -3V$, $I_O = -20$ μ A	4.0	4.9		V	
V_{OL}	Low Level Output Voltage	$V_{IN} = +3V$, $I_O = +2.0$ mA		0.25	0.4	V	

Electrical Characteristics (Note 2) (Continued)

Over recommended operating conditions, unless otherwise specified

Symbol	Parameter	Conditions	Min	Typ	Max	Units
RECEIVER CHARACTERISTICS						
V_{IH}	High Level Input Voltage		2.0		V_{CC}	V
V_{IL}	Low Level Input Voltage		GND		0.8	V
I_{IH}	High Level Input Current	$V_{IN} \geq 2.0V$	-10		+10	μA
I_{IL}	Low Level Input Current	$V_{IN} \leq 0.8V$	-10		+10	μA
I_{OZ}	Output Leakage Current	$\overline{EN} = V_{CC}, 0V \leq R_{OUT} \leq V_{CC}$	-10		+10	μA

Switching Characteristics (Note 4)

Over recommended operating conditions, unless otherwise specified

Symbol	Parameter	Conditions	Min	Typ	Max	Units
DRIVER CHARACTERISTICS						
t_{PLH}	Propagation Delay LOW to HIGH	$R_L = 3\text{ k}\Omega$		0.7	4.0	μs
t_{PHL}	Propagation Delay HIGH to LOW	$C_L = 50\text{ pF}$		0.6	4.0	μs
t_{SK}	Skew $ t_{PLH} - t_{PHL} $	(Figures 1, 2)		0.1	1.0	μs
SR1	Output Slew Rate	$R_L = 3\text{ k}\Omega$ to $7\text{ k}\Omega$, $C_L = 50\text{ pF}$	4.0	15	30	V/ μs
SR2	Output Slew Rate	$R_L = 3\text{ k}\Omega$, $C_L = 2500\text{ pF}$	3.0	5.0		V/ μs
RECEIVER CHARACTERISTICS						
t_{PLH}	Propagation Delay LOW to HIGH	Input Pulse Width > 10 μs		2.0	6.5	μs
t_{PHL}	Propagation Delay HIGH to LOW	$C_L = 50\text{ pF}$		2.8	6.5	μs
t_{SK}	Skew $ t_{PLH} - t_{PHL} $	(Figures 3, 4)		0.8	2.0	μs
t_{PLZ}		(Figures 5, 7)		0.1	2.0	μs
t_{PZL}				0.6	2.0	μs
t_{PHZ}		(Figures 5, 6)		0.2	2.0	μs
t_{PZH}				0.6	2.0	μs
t_{NW}	Noise Pulse Width Rejected	(Figures 3, 4)		2.5	1.0	μs

Note 1: "Absolute Maximum Ratings" are those values beyond which the safety of the device cannot be guaranteed. They are not meant to imply that the devices should be operated at these limits. The tables of "Electrical Characteristics" specify conditions for device operation.

Note 2: Current into device pins is defined as positive. Current out of device pins is defined as negative. All voltages are referenced to ground unless otherwise specified.

Note 3: I_{OS+} and I_{OS-} values are for one output at a time. If more than one output is shorted simultaneously, the device power dissipation may be exceeded.

Note 4: Receiver AC input waveform for test purposes: $t_r = t_f = 200\text{ ns}$, $V_{IH} = 3V$, $V_{IL} = -3V$, $f = 64\text{ kHz}$ (128 kbits/sec). Driver AC input waveform for test purposes: $t_r = t_f \leq 10\text{ ns}$, $V_{IH} = 3V$, $V_{IL} = 0V$, $f = 64\text{ kHz}$ (128 kbits/sec).

Note 5: All typicals are given for $V_{CC} = 5.0V$ and $T_A = +25^\circ C$.

Note 6: Ratings apply to ambient temperature at $+25^\circ C$. Above this temperature derate: WM package 14.3 mW/ $^\circ C$.

Parameter Measurement Information

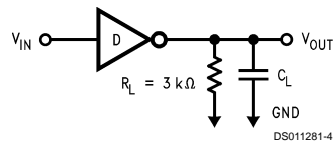

FIGURE 1. Driver Load Circuit

Parameter Measurement Information (Continued)

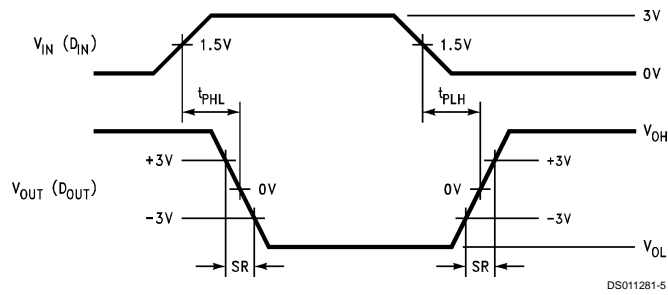

FIGURE 2. Driver Switching Waveform

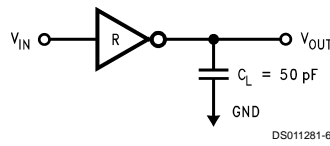

FIGURE 3. Receiver Load Circuit

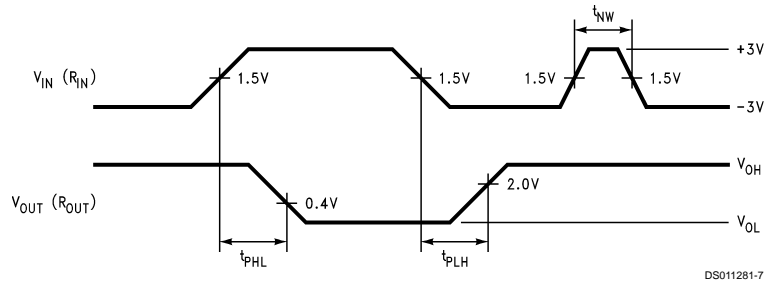

FIGURE 4. Receiver Propagation Delays and Noise Rejection

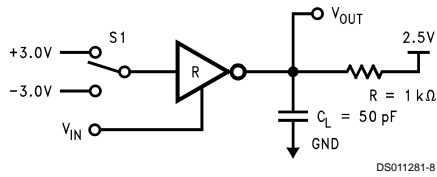

FIGURE 5. Receiver Disable Load Circuit

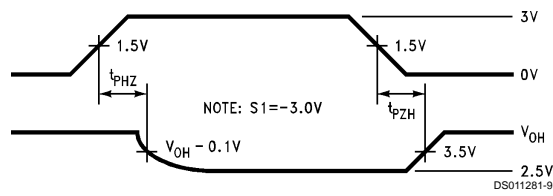

FIGURE 6. Receiver TRI-STATE Timing (t_{PHZ} , t_{PZH})

Parameter Measurement Information (Continued)

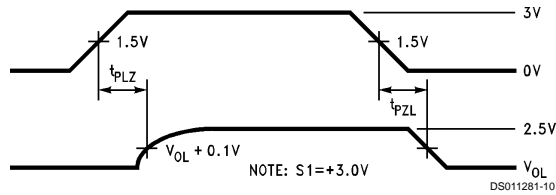

FIGURE 7. Receiver TRI-STATE Timing (t_{PLZ} , t_{PZL})

Pin Descriptions

V_{CC} (pin 11) — Power supply pin for the device, +5V ($\pm 10\%$).

V⁺ (pin 13) — Positive supply for TIA/EIA-232-E drivers. Recommended external capacitor: C4 = 1.0 μ F (6.3V). This supply is not intended to be loaded externally.

V⁻ (pin 17) — Negative supply for TIA/EIA-232-E drivers. Recommended external capacitor: C3 = 1.0 μ F (16V). This supply is not intended to be loaded externally.

C1⁺, C1⁻ (pins 12 and 14) — External capacitor connection pins. Recommended capacitor — 1.0 μ F (6.3V).

C2⁺, C2⁻ (pins 15 and 16) — External capacitor connection pins. Recommended capacitor — 1.0 μ F (16V).

EN (pin 24) — Controls the Receiver output TRI-STATE Circuit. A HIGH level on this pin will disable the Receiver Output.

SHUTDOWN (SD) (pin 25) — A High on the SHUTDOWN pin will lower the total I_{CC} current to less than 10 μ A. Providing a low power state.

D_{IN} 1–4 (pins 7, 6, 20 and 21) — Driver input pins are TTL/CMOS compatible. Inputs of unused drivers may be left open, an internal pull-up resistor (500 k Ω minimum, typically 5 M Ω) pulls input to V_{CC}. Output will be LOW for open inputs.

D_{OUT} 1–4 (pins 2, 3, 1 and 28) — Driver output pins conform to TIA/EIA-232-E levels.

R_{IN} 1–5 (pins 9, 4, 27, 23 and 18) — Receiver input pins accept TIA/EIA-232-E input voltages (± 15 V). Receivers feature a noise filter and guaranteed hysteresis of 200 mV. Unused receiver input pins may be left open. Internal input resistor (5 k Ω) pulls input LOW, providing a failsafe HIGH output.

R_{OUT} 1–5 (pins 8, 5, 26, 22 and 19) — Receiver output pins are TTL/CMOS compatible. Receiver output HIGH voltage is specified for both CMOS and TTL load conditions.

GND (pin 10) — Ground pin.

Typical Performance Characteristics

Slew Rate vs Cap. Load vs V_{CC}
(Four Drivers)

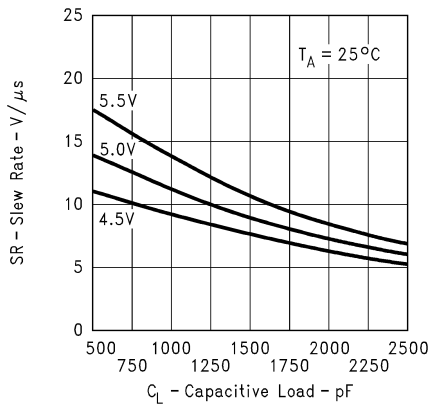

Slew Rate vs Temperature vs
Cap. Load (Four Drivers Switching)

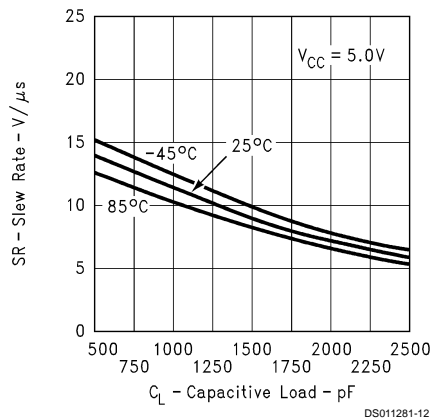

Typical Performance Characteristics (Continued)

**Slew Rate vs Cap. Load vs V_{CC}
(One Driver)**

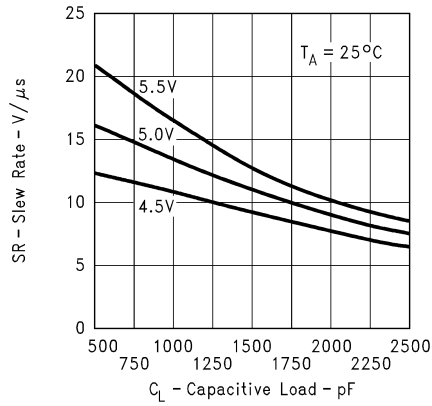

DS011281-13

**Slew Rate vs Temperature vs
Cap. Load (One Driver Switching)**

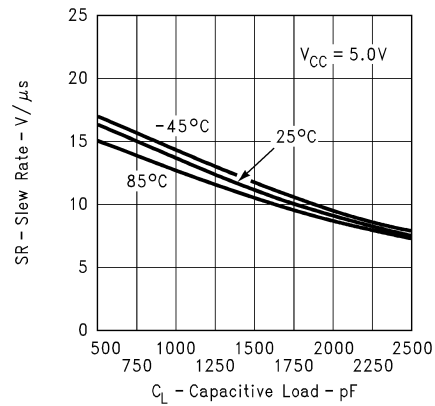

DS011281-14

**Driver Slew Rate vs Cap. Load
vs Number of Drivers**

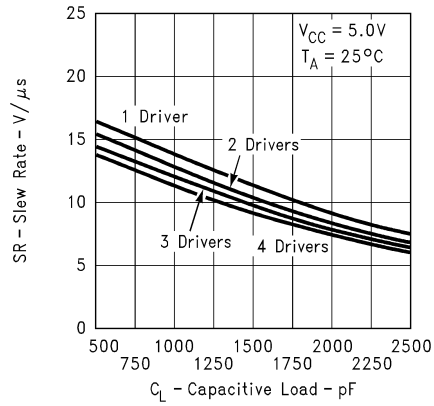

DS011281-15

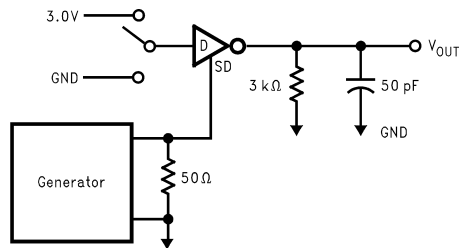

DS011281-16

FIGURE 8. Driver Shutdown (SD) Delay Test Circuit

Typical Performance Characteristics (Continued)

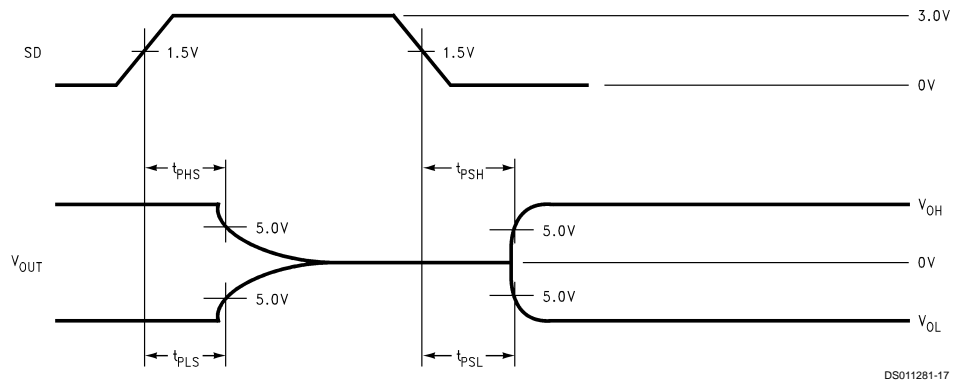

FIGURE 9. Driver Shutdown (SD) Delay Timing Waveforms

Typical data only.

Symbol	Parameter	Conditions	Typ	Units
t_{PHS}	Propagation Delay High to SD	$V_{CC} = 5V$ (Notes 7, 8) $T_A = 25^\circ C$	124	μs
t_{PLS}	Propagation Delay Low to SD		110	μs
t_{PSH}	Propagation Delay SD to High		114	μs
t_{PSL}	Propagation Delay SD to Low		97	μs

Note 7: Sample size = 10 parts; 3 different datecodes.

Note 8: All drivers are loaded as shown in Figure 8.

Physical Dimensions inches (millimeters) unless otherwise noted

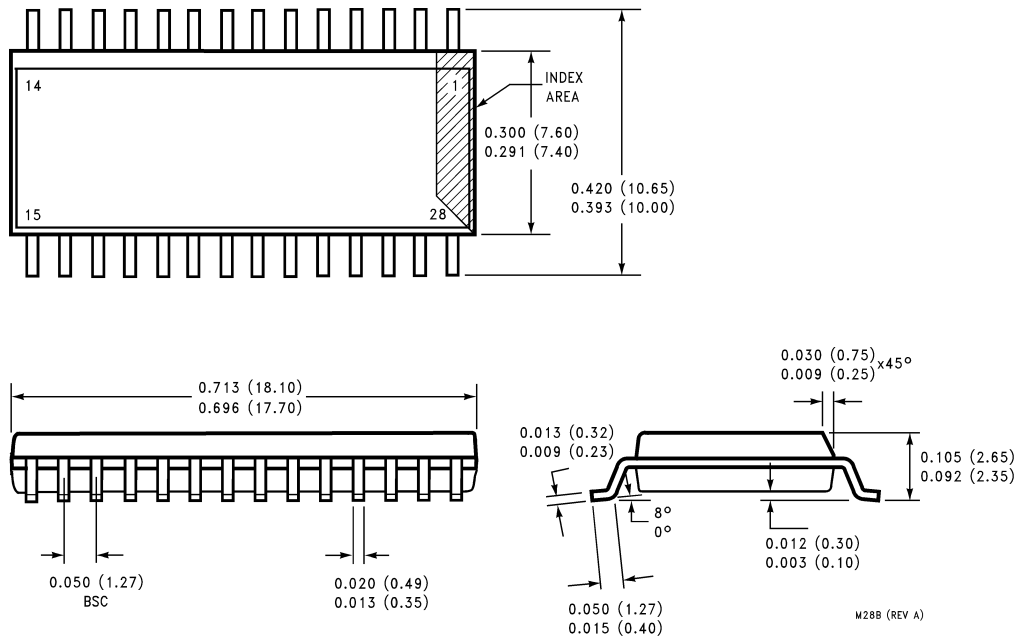

Order Number DS14C241WM
NS Package Number M28B

LIFE SUPPORT POLICY

NATIONAL'S PRODUCTS ARE NOT AUTHORIZED FOR USE AS CRITICAL COMPONENTS IN LIFE SUPPORT DEVICES OR SYSTEMS WITHOUT THE EXPRESS WRITTEN APPROVAL OF THE PRESIDENT OF NATIONAL SEMICONDUCTOR CORPORATION. As used herein:

1. Life support devices or systems are devices or systems which, (a) are intended for surgical implant into the body, or (b) support or sustain life, and whose failure to perform when properly used in accordance with instructions for use provided in the labeling, can be reasonably expected to result in a significant injury to the user.
2. A critical component in any component of a life support device or system whose failure to perform can be reasonably expected to cause the failure of the life support device or system, or to affect its safety or effectiveness.



National Semiconductor Corporation
 Americas
 Tel: 1-800-272-9959
 Fax: 1-800-737-7018
 Email: support@nsc.com

National Semiconductor Europe
 Fax: +49 (0) 1 80-530 85 86
 Email: europe.support@nsc.com
 Deutsch Tel: +49 (0) 1 80-530 85 85
 English Tel: +49 (0) 1 80-532 78 32
 Français Tel: +49 (0) 1 80-532 93 58
 Italiano Tel: +49 (0) 1 80-534 16 80

National Semiconductor Asia Pacific Customer Response Group
 Tel: 65-2544466
 Fax: 65-2504466
 Email: sea.support@nsc.com

National Semiconductor Japan Ltd.
 Tel: 81-3-5620-6175
 Fax: 81-3-5620-6179

www.national.com

Copyright © Each Manufacturing Company.

All Datasheets cannot be modified without permission.

This datasheet has been download from :

www.AllDataSheet.com

100% Free DataSheet Search Site.

Free Download.

No Register.

Fast Search System.

www.AllDataSheet.com