



10-Bit Voltage-Output DACs in 8-Pin μ MAX

MAX5354/MAX5355

General Description

The MAX5354/MAX5355 combine a low-power, voltage-output, 10-bit digital-to-analog converter (DAC) and a precision output amplifier in an 8-pin μ MAX or DIP package. The MAX5354 operates from a single +5V supply, and the MAX5355 operates from a single +3.3V supply. Both devices draw less than 280 μ A of supply current.

The output amplifier's inverting input is available to the user, allowing specific gain configurations, remote sensing, and high output current capability. This makes the MAX5354/MAX5355 ideal for a wide range of applications, including industrial process control. Other features include a software shutdown and power-on reset.

The serial interface is compatible with SPI™/QSPI™ and Microwire™. The DAC has a double-buffered input, organized as an input register followed by a DAC register. A 16-bit serial word loads data into the input register. The DAC register can be updated independently or simultaneously with the input register. All logic inputs are TTL/CMOS-logic compatible and buffered with Schmitt triggers to allow direct interfacing to optocouplers.

Applications

- Digital Offset and Gain Adjustment
- Industrial Process Controls
- Microprocessor-Controlled Systems
- Portable Test Instruments
- Remote Industrial Controls

Functional Diagram

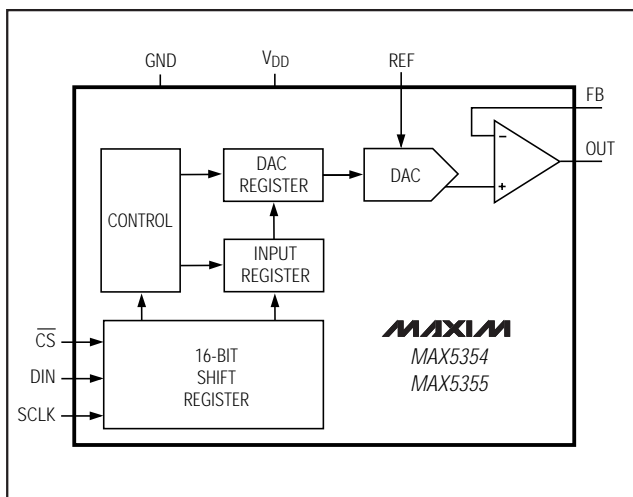

SPI and QSPI are trademarks of Motorola, Inc. Microwire is a trademark of National Semiconductor Corp.

Features

- ◆ 10-Bit DAC with Configurable Output Amplifier
- ◆ +5V Single-Supply Operation (MAX5354)
+3.3V Single-Supply Operation (MAX5355)
- ◆ Low Supply Current: 0.28mA Normal Operation
2 μ A Shutdown Mode
- ◆ Available in 8-Pin μ MAX
- ◆ Power-On Reset Clears DAC Output to Zero
- ◆ SPI/QSPI and Microwire Compatible
- ◆ Schmitt-Trigger Digital Inputs for Direct Optocoupler Interface
- ◆ +3.3V MAX5355 Directly Interfaces with +5V Logic

Ordering Information

PART*	TEMP. RANGE	PIN-PACKAGE
MAX5354CPA	0°C to +70°C	8 Plastic DIP
MAX5354CUA	0°C to +70°C	8 μ MAX
MAX5354EPA	-40°C to +85°C	8 Plastic DIP
MAX5354EUA	-40°C to +85°C	8 μ MAX
MAX5354MJA	-55°C to +125°C	8 CERDIP**

Ordering Information continued at end of data sheet.

* Contact factory for availability of 8-pin SO package.

** Contact factory for availability and processing to MIL-STD-883.

Pin Configuration

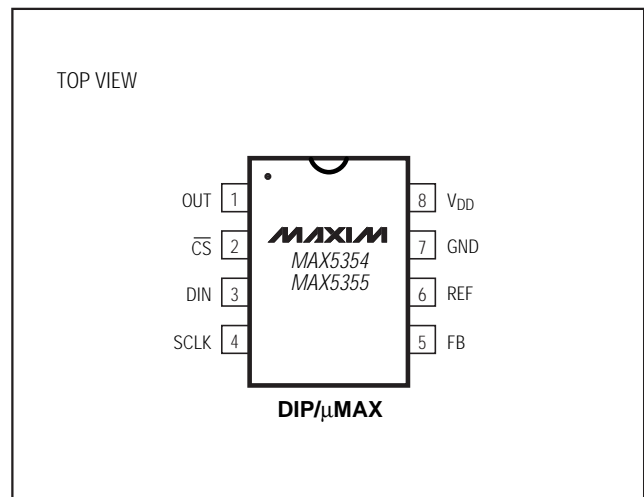

10-Bit Voltage-Output DACs in 8-Pin μ MAX

ABSOLUTE MAXIMUM RATINGS

V_{DD} to GND	-0.3V to +6V
REF, OUT, FB to GND	-0.3V to (V_{DD} + 0.3V)
Digital Inputs to GND	-0.3V to +6V
Continuous Current into Any Pin.....	± 20 mA
Continuous Power Dissipation ($T_A = +70^\circ\text{C}$)	
Plastic DIP (derate 9.09mW/ $^\circ\text{C}$ above +70 $^\circ\text{C}$)	727mW
μ MAX (derate 4.10mW/ $^\circ\text{C}$ above +70 $^\circ\text{C}$)	330mW
CERDIP (derate 8.00mW/ $^\circ\text{C}$ above +70 $^\circ\text{C}$)	640mW

Operating Temperature Ranges

MAX5354C_A/MAX5355C_A	0 $^\circ\text{C}$ to +70 $^\circ\text{C}$
MAX5354E_A/MAX5355E_A	-40 $^\circ\text{C}$ to +85 $^\circ\text{C}$
MAX5354MJA/MAX5355MJA	-55 $^\circ\text{C}$ to +125 $^\circ\text{C}$
Storage Temperature Range	-65 $^\circ\text{C}$ to +150 $^\circ\text{C}$
Lead Temperature (soldering, 10sec)	+300 $^\circ\text{C}$

Stresses beyond those listed under "Absolute Maximum Ratings" may cause permanent damage to the device. These are stress ratings only, and functional operation of the device at these or any other conditions beyond those indicated in the operational sections of the specifications is not implied. Exposure to absolute maximum rating conditions for extended periods may affect device reliability.

ELECTRICAL CHARACTERISTICS: MAX5354

($V_{DD} = +5V \pm 10\%$, GND = 0V, REF = 2.5V, $R_L = 5k\Omega$, $C_L = 100\text{pF}$, $T_A = T_{MIN}$ to T_{MAX} , unless otherwise noted. Typical values are at $T_A = +25^\circ\text{C}$. Output buffer connected in unity-gain configuration (Figure 8).)

PARAMETER	SYMBOL	CONDITIONS	MIN	TYP	MAX	UNITS
STATIC PERFORMANCE—ANALOG SECTION						
Resolution	N		10			Bits
Integral Nonlinearity (Note 1)	INL	MAX5354C/E			± 1	LSB
		MAX5354M			± 2	
Differential Nonlinearity	DNL	Guaranteed monotonic			± 1.0	LSB
Offset Error	VOS			± 0.3	± 8	mV
Offset-Error Tempco	TCVOS			6		ppm/ $^\circ\text{C}$
Gain Error (Note 1)	GE			-0.3	± 2	LSB
Gain-Error Tempco				1		ppm/ $^\circ\text{C}$
Power-Supply Rejection Ratio	PSRR	$4.5V \leq V_{DD} \leq 5.5V$			800	$\mu\text{V/V}$
REFERENCE INPUT						
Reference Input Range	V_{REF}		0		$V_{DD} - 1.4$	V
Reference Input Resistance	R_{REF}	Code dependent, minimum at code 1550 hex	18	30		$k\Omega$
MULTIPLYING-MODE PERFORMANCE						
Reference -3dB Bandwidth		$V_{REF} = 0.67V_{p-p}$		650		kHz
Reference Feedthrough		Input code = all 0s, $V_{REF} = 3.6V_{p-p}$ at 1kHz		-84		dB
Signal-to-Noise Plus Distortion Ratio	SINAD	$V_{REF} = 1V_{p-p}$ at 25kHz, code = full scale		77		dB
DIGITAL INPUTS						
Input High Voltage	V_{IH}		2.4			V
Input Low Voltage	V_{IL}				0.8	V
Input Leakage Current	I_{IN}	$V_{IN} = 0V$ or V_{DD}		0.001	± 0.5	μA
Input Capacitance	C_{IN}			8		pF

10-Bit Voltage-Output DACs in 8-Pin μ MAX

MAX5354/MAX5355

ELECTRICAL CHARACTERISTICS: MAX5354 (continued)

($V_{DD} = +5V \pm 10\%$, $GND = 0V$, $REF = 2.5V$, $R_L = 5k\Omega$, $C_L = 100pF$, $T_A = T_{MIN}$ to T_{MAX} , unless otherwise noted. Typical values are at $T_A = +25^\circ C$. Output buffer connected in unity-gain configuration (Figure 8).)

PARAMETER	SYMBOL	CONDITIONS	MIN	TYP	MAX	UNITS
DYNAMIC PERFORMANCE						
Voltage Output Slew Rate	SR			0.6		V/ μ s
Output Settling Time		To $\pm 1/2$ LSB, $V_{STEP} = 2.5V$		10		μ s
Output Voltage Swing		Rail-to-rail (Note 2)		0 to V_{DD}		V
Current into FB				0.001	± 0.1	μ A
Start-Up Time				20		μ s
Digital Feedthrough		$\overline{CS} = V_{DD}$, $DIN = 100kHz$		5		nV-s
POWER SUPPLIES						
Supply Voltage	V_{DD}		4.5		5.5	V
Supply Current	I_{DD}	(Note 3)		0.28	0.4	mA
Supply Current in Shutdown		(Note 3)		4	20	μ A
Reference Current in Shutdown				0.001	± 0.5	μ A
TIMING CHARACTERISTICS (Figure 6)						
SCLK Clock Period	tCP		100			ns
SCLK Pulse Width High	tCH		40			ns
SCLK Pulse Width Low	tCL		40			ns
\overline{CS} Fall to SCLK Rise Setup Time	tCSS		40			ns
SCLK Rise to \overline{CS} Rise Hold Time	tCSH		0			ns
DIN Setup Time	tDS		40			ns
DIN Hold Time	tDH		0			ns
SCLK Rise to \overline{CS} Fall Delay	tCS0		40			ns
\overline{CS} Rise to SCLK Rise Hold Time	tCS1		40			ns
\overline{CS} Pulse Width High	tCSW		100			ns

Note 1: Guaranteed from code 3 to code 1023 in unity-gain configuration.

Note 2: Accuracy is better than 1LSB for $V_{OUT} = 8mV$ to $V_{DD} - 100mV$, guaranteed by a power-supply rejection test at the end points.

Note 3: $R_L = \infty$, digital inputs at GND or V_{DD} .

10-Bit Voltage-Output DACs in 8-Pin μ MAX

ELECTRICAL CHARACTERISTICS: MAX5355

($V_{DD} = +3.15V$ to $+3.6V$, $V_{REF} = 1.25V$, $GND = 0V$, $R_L = 5k\Omega$, $C_L = 100pF$, $T_A = T_{MIN}$ to T_{MAX} , unless otherwise noted. Typical values are at $T_A = +25^\circ C$. Output buffer connected in unity-gain configuration (Figure 8).)

PARAMETER	SYMBOL	CONDITIONS	MIN	TYP	MAX	UNITS
STATIC PERFORMANCE—ANALOG SECTION						
Resolution	N		10			Bits
Integral Nonlinearity (Note 4)	INL	MAX5355C/E			± 1	LSB
		MAX5355M			± 2	
Differential Nonlinearity	DNL	Guaranteed monotonic			± 1.0	LSB
Offset Error	V_{OS}			± 0.3	± 8	mV
Offset-Error Tempco	TCV_{OS}			6		ppm/ $^\circ C$
Gain Error (Note 4)	GE			-0.3	± 2	LSB
Gain-Error Tempco				1		ppm/ $^\circ C$
Power-Supply Rejection Ratio	PSRR				800	$\mu V/V$
REFERENCE INPUT						
Reference Input Range	V_{REF}		0		$V_{DD} - 1.4$	V
Reference Input Resistance	R_{REF}	Code dependent, minimum at code 1550 hex	18	30		k Ω
MULTIPLYING-MODE PERFORMANCE ($V_{DD} = +3.3V$)						
Reference -3dB Bandwidth		$V_{REF} = 0.67V_{p-p}$		650		kHz
Reference Feedthrough		Input code = all 0s, $V_{REF} = 1.9V_{p-p}$ at 1kHz		-84		dB
Signal-to-Noise Plus Distortion Ratio	SINAD	$V_{REF} = 1V_{p-p}$ at 25kHz, code = full scale		72		dB
DIGITAL INPUTS						
Input High Voltage	V_{IH}		2.4			V
Input Low Voltage	V_{IL}				0.6	V
Input Leakage Current	I_{IN}	$V_{IN} = 0V$ or V_{DD}		0.001	± 0.5	μA
Input Capacitance	C_{IN}			8		pF
DYNAMIC PERFORMANCE						
Voltage Output Slew Rate	SR			0.6		V/ μs
Output Settling Time		To $\pm 1/2$ LSB, $V_{STEP} = 1.25V$		10		μs
Output Voltage Swing		Rail-to-rail (Note 5)		0 to V_{DD}		V
Current into FB				0.001	± 0.1	μA
Start-Up Time				20		μs
Digital Feedthrough		$\overline{CS} = V_{DD}$, $DIN = 100kHz$		5		nV-s
POWER SUPPLIES						
Supply Voltage	V_{DD}		3.15		3.6	V
Supply Current	I_{DD}	(Note 6)		0.24	0.4	mA
Supply Current in Shutdown		(Note 6)		1.6	10	μA
Reference Current in Shutdown				0.001	± 0.5	μA

10-Bit Voltage-Output DACs in 8-Pin μ MAX

MAX5354/MAX5355

ELECTRICAL CHARACTERISTICS: MAX5355 (continued)

($V_{DD} = +3.15V$ to $+3.6V$, $REF = 1.25V$, $GND = 0V$, $R_L = 5k\Omega$, $C_L = 100pF$, $T_A = T_{MIN}$ to T_{MAX} , unless otherwise noted. Typical values are at $T_A = +25^\circ C$. Output buffer connected in unity-gain configuration (Figure 8).)

PARAMETER	SYMBOL	CONDITIONS	MIN	TYP	MAX	UNITS
TIMING CHARACTERISTICS (Figure 6)						
SCLK Clock Period	t_{CP}		100			ns
SCLK Pulse Width High	t_{CH}		40			ns
SCLK Pulse Width Low	t_{CL}		40			ns
\overline{CS} Fall to SCLK Rise Setup Time	t_{CSS}		40			ns
SCLK Rise to \overline{CS} Rise Hold Time	t_{CSH}		0			ns
DIN Setup Time	t_{DS}		40			ns
DIN Hold Time	t_{DH}		0			ns
SCLK Rise to \overline{CS} Fall Delay	t_{CS0}		40			ns
\overline{CS} Rise to SCLK Rise Hold Time	t_{CS1}		40			ns
\overline{CS} Pulse Width High	t_{CSW}		100			ns

Note 4: Guaranteed from code 6 to code 1023 in unity-gain configuration.

Note 5: Accuracy is better than 1LSB for $V_{OUT} = 8mV$ to $V_{DD} - 150mV$, guaranteed by a power-supply rejection test at the end points.

Note 6: $R_L = \infty$, digital inputs at GND or V_{DD} .

10-Bit Voltage-Output DACs in 8-Pin μ MAX

Typical Operating Characteristics

(MAX5354 only, $V_{DD} = +5V$, $R_L = 5k\Omega$, $C_L = 100pF$, $T_A = +25^\circ C$, unless otherwise noted.)

MAX5354

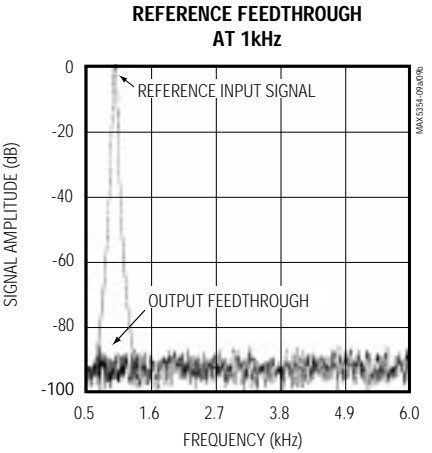
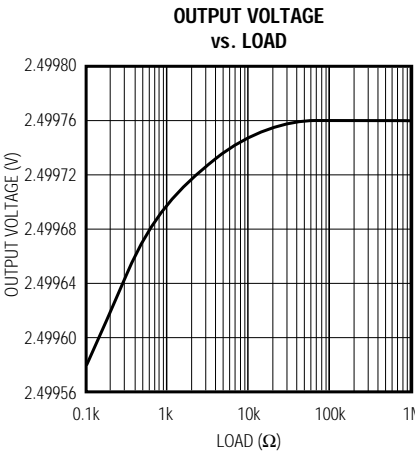
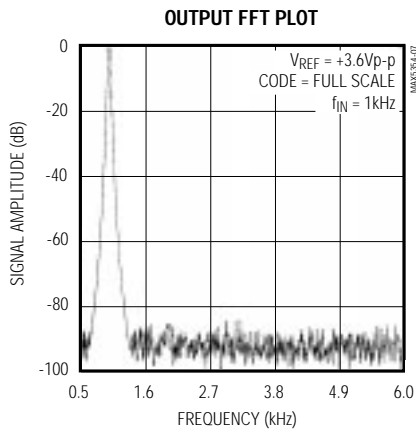
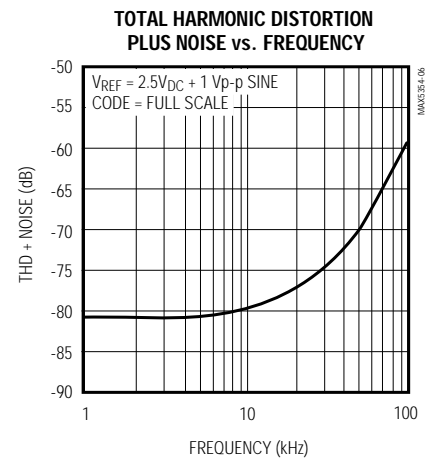
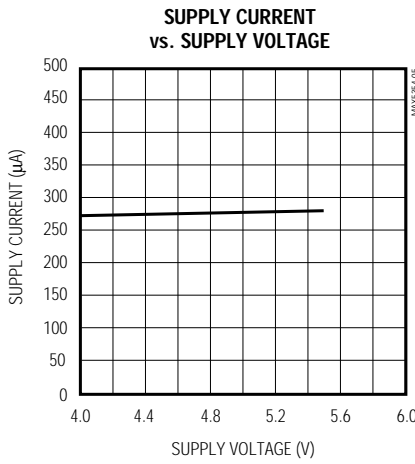
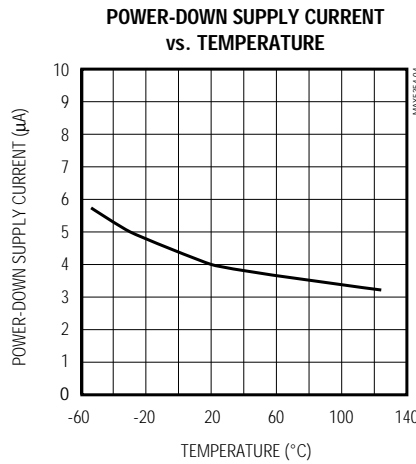
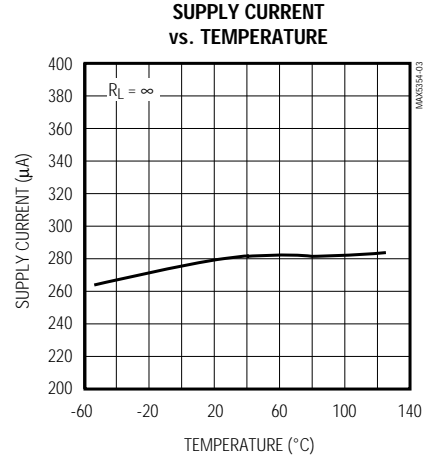
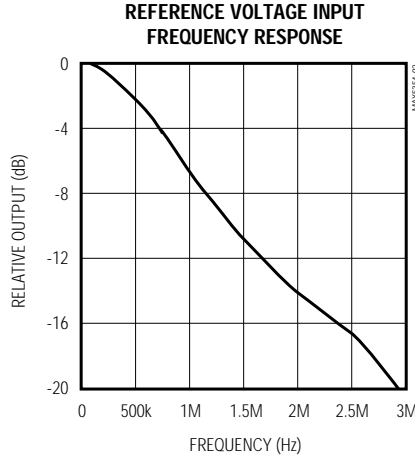
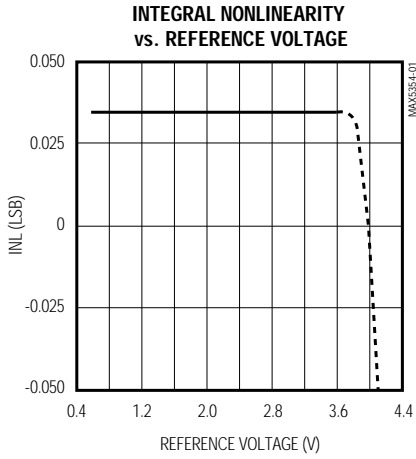

10-Bit Voltage-Output DACs in 8-Pin μ MAX

Typical Operating Characteristics (continued)

(MAX5354 only, $V_{DD} = +5V$, $R_L = 5k\Omega$, $C_L = 100pF$, $T_A = +25^\circ C$, unless otherwise noted.)

MAX5354 (continued)

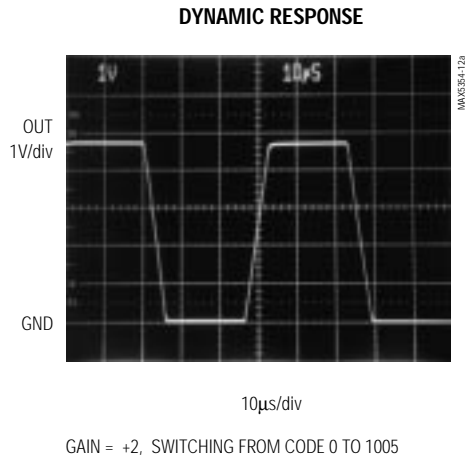
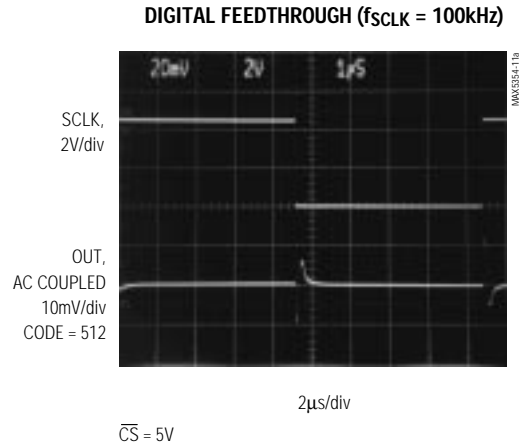
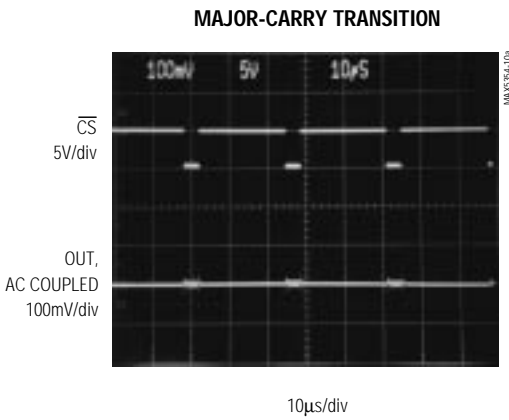

MAX5354/MAX5355

10-Bit Voltage-Output DACs in 8-Pin μ MAX

Typical Operating Characteristics (continued)

(MAX5355 only, $V_{DD} = +3.3V$, $R_L = 5k\Omega$, $C_L = 100pF$, $T_A = +25^\circ C$, unless otherwise noted.)

MAX5355

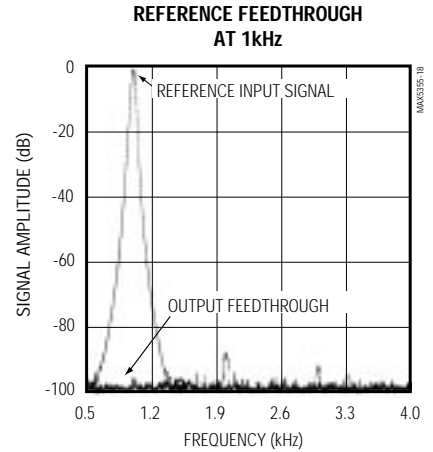
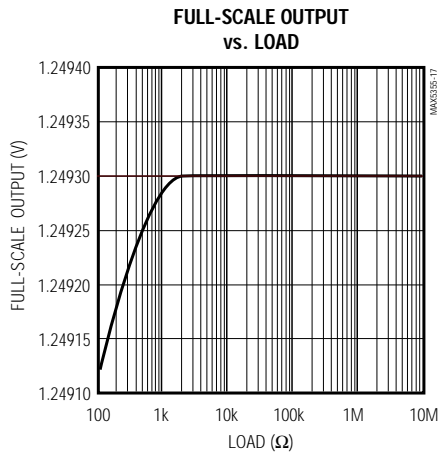
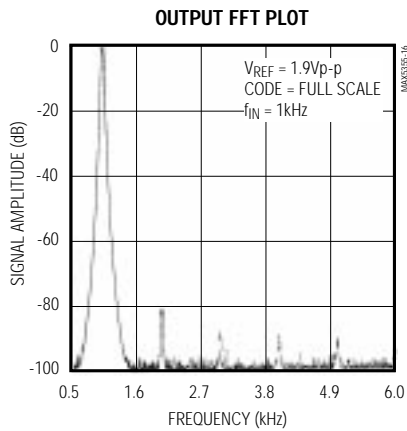
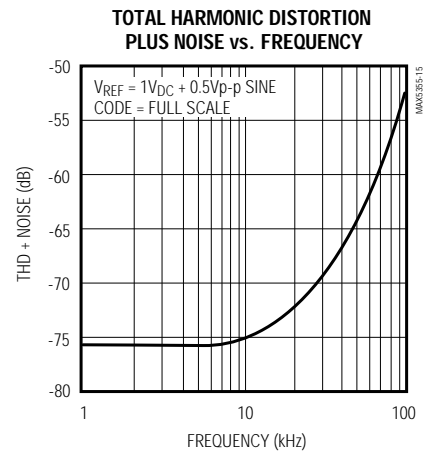
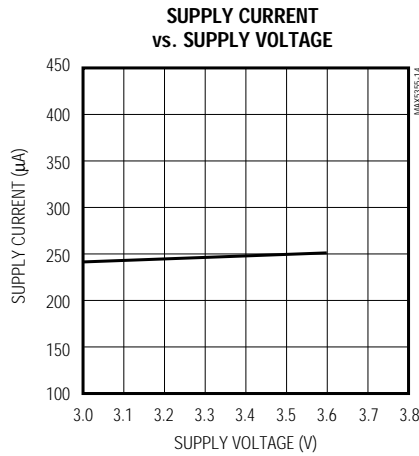
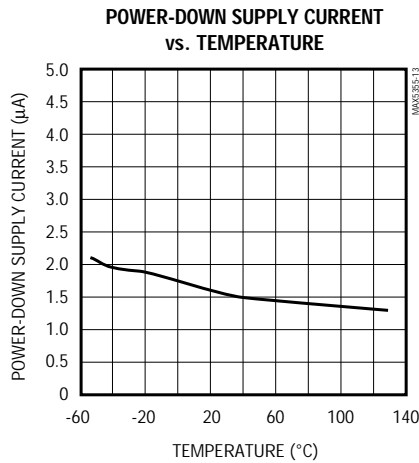
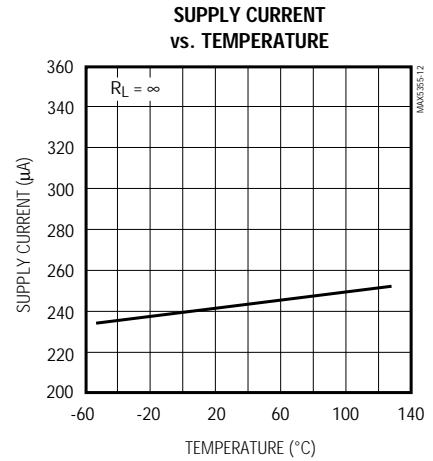
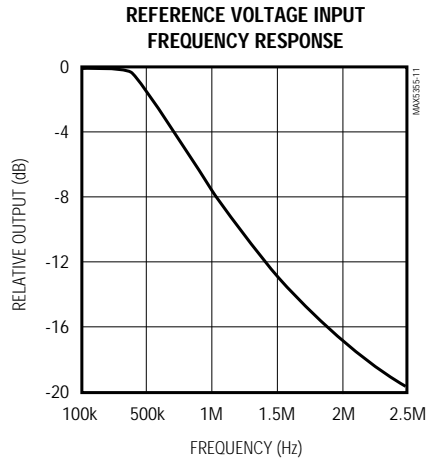
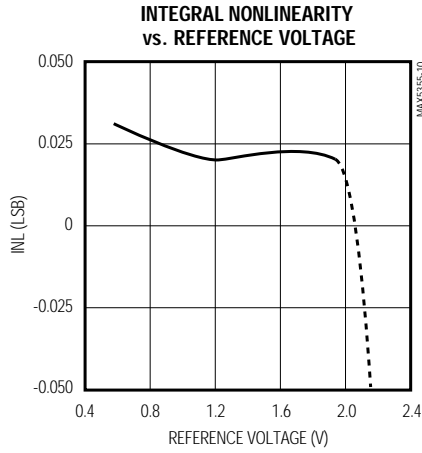

10-Bit Voltage-Output DACs in 8-Pin μ MAX

MAX5354/MAX5355

Pin Description

PIN	NAME	FUNCTION
1	OUT	DAC Output Voltage
2	$\overline{\text{CS}}$	Chip-Select Input. Active low.
3	DIN	Serial-Data Input
4	SCLK	Serial-Clock Input
5	FB	DAC Output Amplifier Feedback
6	REF	Reference Voltage Input
7	GND	Ground
8	V _{DD}	Positive Power Supply

Detailed Description

The MAX5354/MAX5355 contain a voltage-output digital-to-analog converter (DAC) that is easily addressed using a simple 3-wire serial interface. Each IC includes a 16-bit shift register, and has a double-buffered input composed of an input register and a DAC register (see *Functional Diagram*). In addition to the voltage output, the amplifier's negative input is available to the user.

The DAC is an inverted R-2R ladder network that converts a digital input (10 data bits plus three sub-bits) into an equivalent analog output voltage in proportion to the applied reference voltage. Figure 1 shows a simplified circuit diagram of the DAC.

Reference Inputs

The reference input accepts positive DC and AC signals. The voltage at the reference input sets the full-scale output voltage for the DAC. The reference input voltage range is 0V to (V_{DD} - 1.4V). The output voltage (V_{OUT}) is represented by a digitally programmable voltage source, as expressed in the following equation:

$$V_{\text{OUT}} = (V_{\text{REF}} \times \text{NB} / 1024) \times \text{Gain}$$

where NB is the numeric value of the DAC's binary input code (0 to 1023), V_{REF} is the reference voltage, and Gain is the externally set voltage gain.

The impedance at the reference input is code dependent, ranging from a low value of 18k Ω when the DAC has an input code of 1550 hex, to a high value exceeding several giga ohms (leakage currents) with an input code of 0000 hex. Because the input impedance at the reference pin is code dependent, load regulation of the reference source is important.

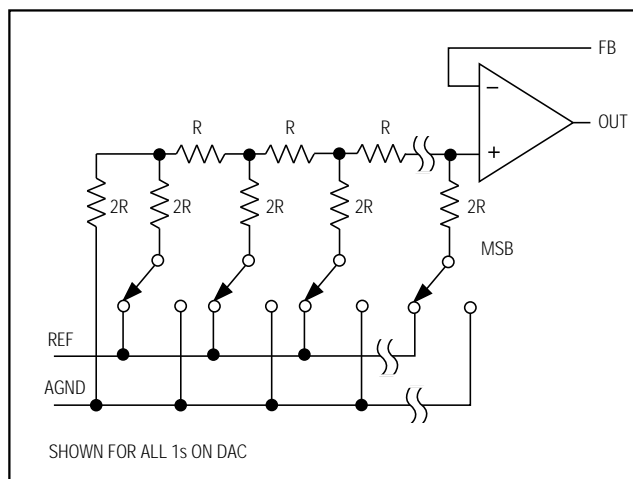

Figure 1. Simplified DAC Circuit Diagram

In shutdown mode, the MAX5354/MAX5355's REF input enters a high-impedance state with a typical input leakage current of 0.001 μ A.

The reference input capacitance is also code dependent and typically ranges from 15pF (with an input code of all 0s) to 50pF (at full scale).

The MAX873 +2.5V reference is recommended for use with the MAX5354.

Output Amplifier

The MAX5354/MAX5355's DAC output is internally buffered by a precision amplifier with a typical slew rate of 0.6V/ μ s. Access to the output amplifier's inverting input provides the user greater flexibility in output gain setting/signal conditioning (see the *Applications Information* section).

With a full-scale transition at the MAX5354/MAX5355 output, the typical settling time to $\pm 1/2$ LSB is 10 μ s when loaded with 5k Ω in parallel with 100pF (loads less than 2k Ω degrade performance).

The amplifier's output dynamic responses and settling performances are shown in the *Typical Operating Characteristics*.

Shutdown Mode

The MAX5354/MAX5355 feature a software-programmable shutdown that reduces supply current to a typical value of 4 μ A. Writing 111X XXXX XXXX XXXX as the input-control word puts the device in shutdown mode (Table 1).

10-Bit Voltage-Output DACs in 8-Pin μ MAX

In shutdown mode, the amplifier's output and the reference input enter a high-impedance state. The serial interface remains active. Data in the input register is retained in shutdown, allowing the MAX5354/MAX5355 to recall the output state prior to entering shutdown. Exit shutdown mode by either recalling the previous configuration or updating the DAC with new data. When powering up the device or bringing it out of shutdown, allow 20 μ s for the outputs to stabilize.

Serial-Interface Configurations

The MAX5354/MAX5355's 3-wire serial interface is compatible with both Microwire™ (Figure 2) and SPI™/QSPI™ (Figure 3). The serial input word consists of three control bits followed by 10+3 data bits (MSB first), as shown in Figure 4. The 3-bit control code determines the MAX5354/MAX5355's response outlined in Table 1.

The MAX5354/MAX5355's digital inputs are double buffered. Depending on the command issued through the serial interface, the input register can be loaded without affecting the DAC register, the DAC register can be loaded directly, or the DAC register can be updated from the input register (Table 1).

The +3.3V MAX5355 can also directly interface with +5V logic.

Serial-Interface Description

The MAX5354/MAX5355 require 16 bits of serial data. Table 1 lists the serial-interface programming commands. For certain commands, the 10+3 data bits are "don't cares." Data is sent MSB first and can be sent in two 8-bit packets or one 16-bit word (\overline{CS} must remain low until 16 bits are transferred). The serial data is composed of three control bits (C2, C1, C0), followed by the 10+3 data bits D9...D0, S2, S1, S0 (Figure 4). Set the sub-bits (S2, S1, S0) to zero. The 3-bit control code determines:

- the register to be updated,
- the configuration when exiting shutdown.

Figure 5 shows the serial-interface timing requirements. The chip-select pin (\overline{CS}) must be low to enable the DAC's serial interface. When \overline{CS} is high, the interface control circuitry is disabled. \overline{CS} must go low at least t_{CSS} before the rising serial clock (SCLK) edge to properly clock in the first bit. When \overline{CS} is low, data is clocked into the internal shift register via the serial-data input pin (DIN) on SCLK's rising edge. The maximum guaranteed clock frequency is 10MHz. Data is latched into the MAX5354/MAX5355 input/DAC register on \overline{CS} 's rising edge.

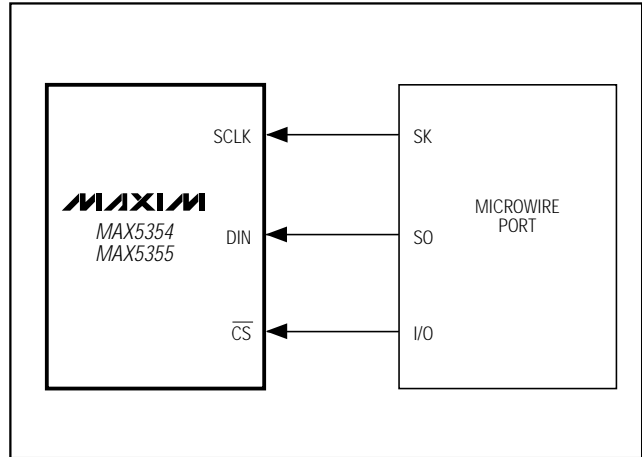

Figure 2. Connections for Microwire

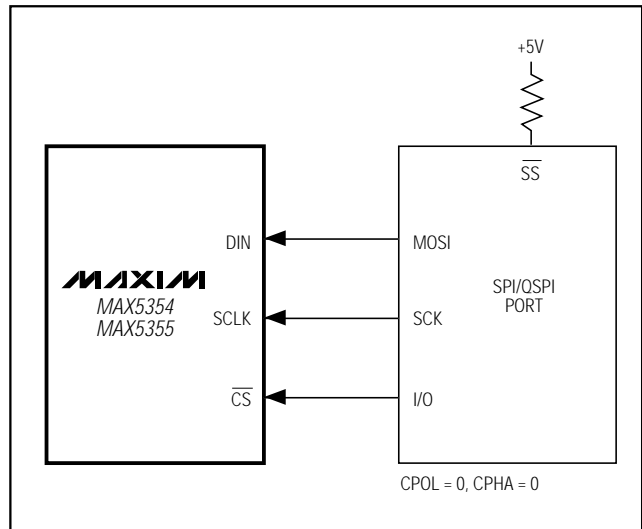

Figure 3. Connections for SPI/QSPI

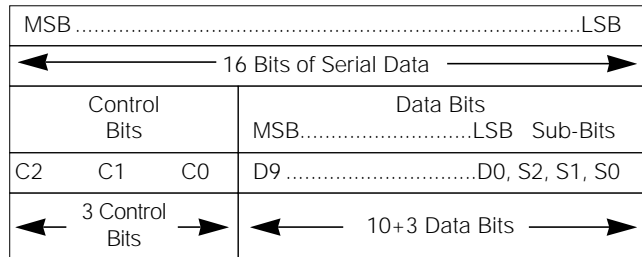

Figure 4. Serial-Data Format

10-Bit Voltage-Output DACs in 8-Pin μ MAX

MAX5354/MAX5355

Table 1. Serial-Interface Programming Commands

16-BIT SERIAL WORD					FUNCTION
C2	C1	C0	D9.....D0 MSB LSB	S2...S0	
X	0	0	10 bits of data	000	Load input register; DAC register immediately updated (also exit shutdown).
X	0	1	10 bits of data	000	Load input register; DAC register unchanged.
X	1	0	XXXXXXXXXX	XXX	Update DAC register from input register (also exit shutdown; recall previous state).
1	1	1	XXXXXXXXXX	XXX	Shutdown
0	1	1	XXXXXXXXXX	XXX	No operation (NOP)

*X" = Don't care

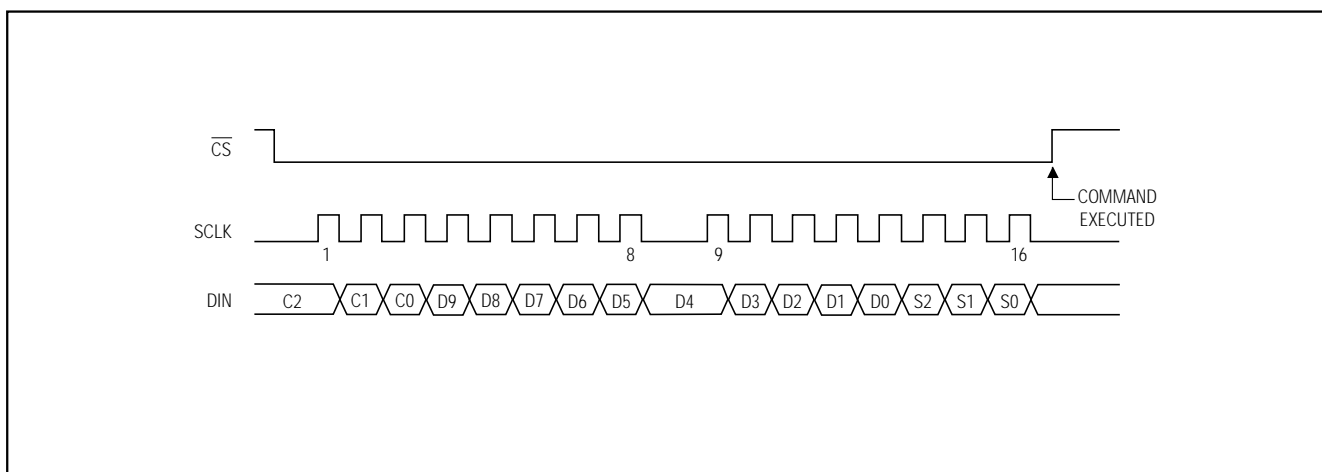

Figure 5. Serial-Interface Timing Diagram

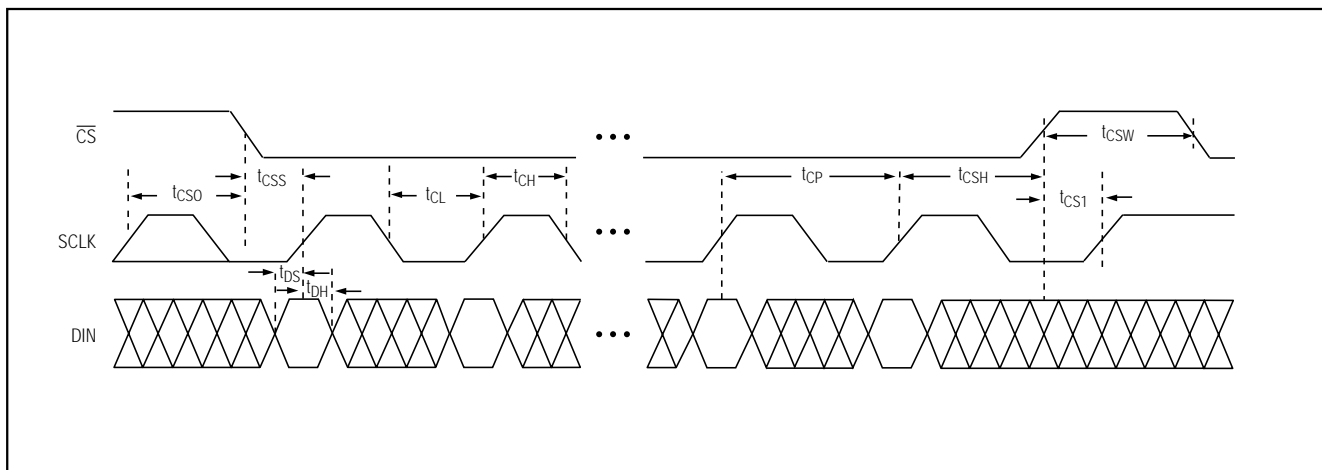

Figure 6. Detailed Serial-Interface Timing Diagram

10-Bit Voltage-Output DACs in 8-Pin μ MAX

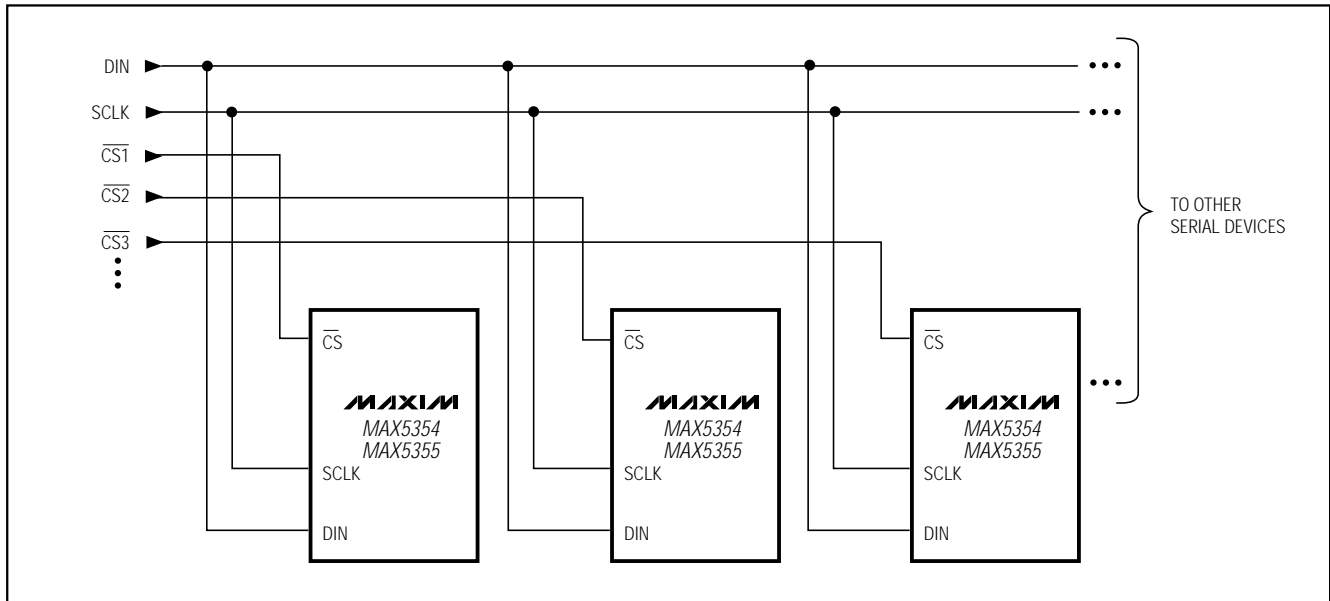

Figure 7. Multiple MAX5354/MAX5355s Sharing Common DIN and SCLK Lines

Figure 7 shows a method of connecting several MAX5354/MAX5355s. In this configuration, the clock and the data bus are common to all devices, and separate chip-select lines are used for each IC.

Applications Information

Unipolar Output

For a unipolar output, the output voltage and the reference input have the same polarity. Figure 8 shows the MAX5354/MAX5355 unipolar output circuit, which is also the typical operating circuit. Table 2 lists the unipolar output codes.

Figure 9 illustrates a rail-to-rail output configuration. This circuit shows the MAX5354 with the output amplifier configured for a closed-loop gain of +2, to provide a 0V to 5V full-scale range when a 2.5V reference is used. When the MAX5355 is used with a 1.25V reference, this circuit provides a 0V to 2.5V full-scale range.

Bipolar Output

The MAX5354/MAX5355 output can be configured for bipolar operation using Figure 10's circuit, according to the following equation:

$$V_{OUT} = V_{REF} [(2NB / 1024) - 1]$$

where NB is the numeric value of the DAC's binary input code. Table 3 shows digital codes (offset binary) and corresponding output voltage for Figure 10's circuit.

Table 2. Unipolar Code Table

DAC CONTENTS		ANALOG OUTPUT
MSB	LSB	
11	1111 1111 (000)	$+V_{REF} \left(\frac{1023}{1024} \right)$
10	0000 0001 (000)	$+V_{REF} \left(\frac{513}{1024} \right)$
10	0000 0000 (000)	$+V_{REF} \left(\frac{512}{1024} \right) = \frac{+V_{REF}}{2}$
01	1111 1111 (000)	$+V_{REF} \left(\frac{511}{1024} \right)$
00	0000 0001 (000)	$+V_{REF} \left(\frac{1}{1024} \right)$
00	0000 0000 (000)	0V

NOTE: () are for sub-bits.

Using an AC Reference

In applications where the reference has AC-signal components, the MAX5354/MAX5355 have multiplying capability within the reference input range specifications. Figure 11 shows a technique for applying a sine-wave signal to the reference input where the AC signal is offset before being applied to REF. The reference voltage must never be more negative than GND.

10-Bit Voltage-Output DACs in 8-Pin μ MAX

MAX5354/MAX5355

Table 3. Bipolar Code Table

DAC CONTENTS MSB	LSB	ANALOG OUTPUT
11 1111 1111	(000)	$+V_{REF} \left(\frac{511}{512} \right)$
10 0000 0001	(000)	$+V_{REF} \left(\frac{1}{512} \right)$
10 0000 0000	(000)	0V
01 1111 1111	(000)	$-V_{REF} \left(\frac{1}{512} \right)$
00 0000 0001	(000)	$-V_{REF} \left(\frac{511}{512} \right)$
00 0000 0000	(000)	$-V_{REF} \left(\frac{512}{512} \right) = -V_{REF}$

NOTE: () are for sub-bits.

The MAX5354's total harmonic distortion plus noise (THD+N) is typically less than -77dB (full-scale code), and the MAX5355's THD+N is typically less than -72dB (full-scale code), given a 1Vp-p signal swing and input frequencies up to 25kHz. The typical -3dB frequency is 650kHz for both devices, as shown in the *Typical Operating Characteristics* graphs.

Digitally Programmable Current Source

The circuit of Figure 12 places an NPN transistor (2N3904 or similar) within the op-amp feedback loop to implement a digitally programmable, unidirectional current source. The output current is calculated with the following equation:

$$I_{OUT} = (V_{REF}/R) \times (NB/1024)$$

where NB is the numeric value of the DAC's binary input code and R is the sense resistor shown in Figure 12.

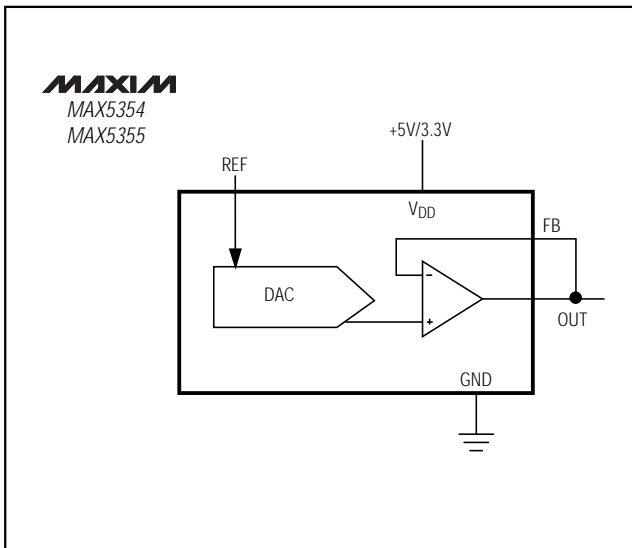

Figure 8. Unipolar Output Circuit

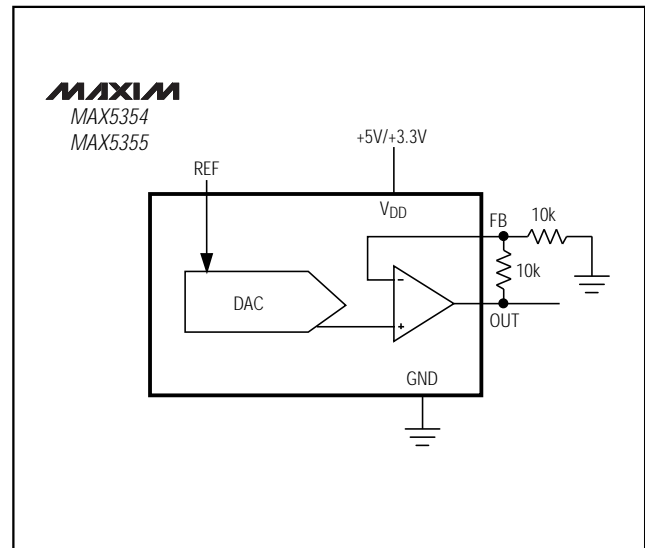

Figure 9. Unipolar Rail-to-Rail Output Circuit

10-Bit Voltage-Output DACs in 8-Pin μ MAX

MAX5354/MAX5355

Ordering Information (continued)

PART*	TEMP. RANGE	PIN-PACKAGE
MAX5355CPA	0°C to +70°C	8 Plastic DIP
MAX5355CUA	0°C to +70°C	8 μ MAX
MAX5355EPA	-40°C to +85°C	8 Plastic DIP
MAX5355EUA	-40°C to +85°C	8 μ MAX
MAX5355MJA	-55°C to +125°C	8 CERDIP**

* Contact factory for availability of 8-pin SO package.

** Contact factory for availability and processing to MIL-STD-883.

Chip Information

TRANSISTOR COUNT: 1677

Package Information

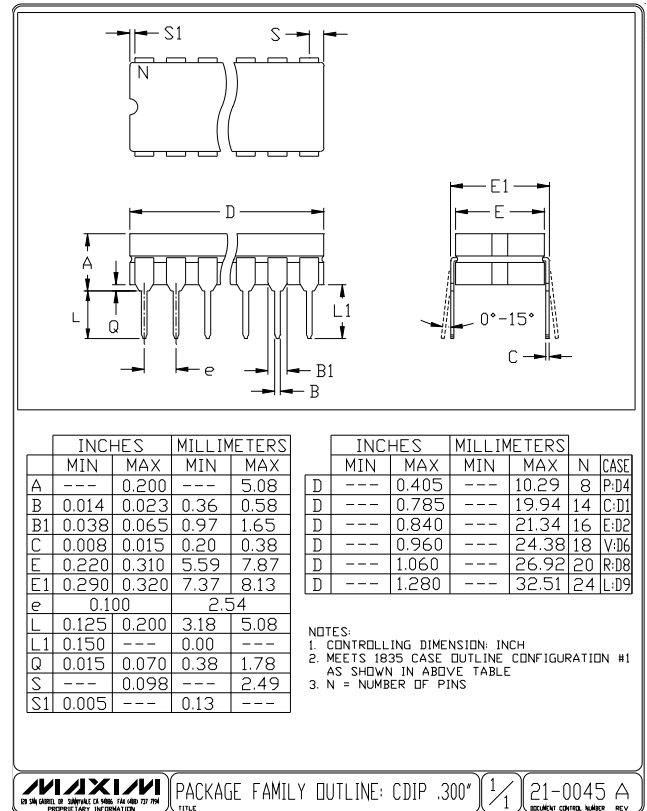
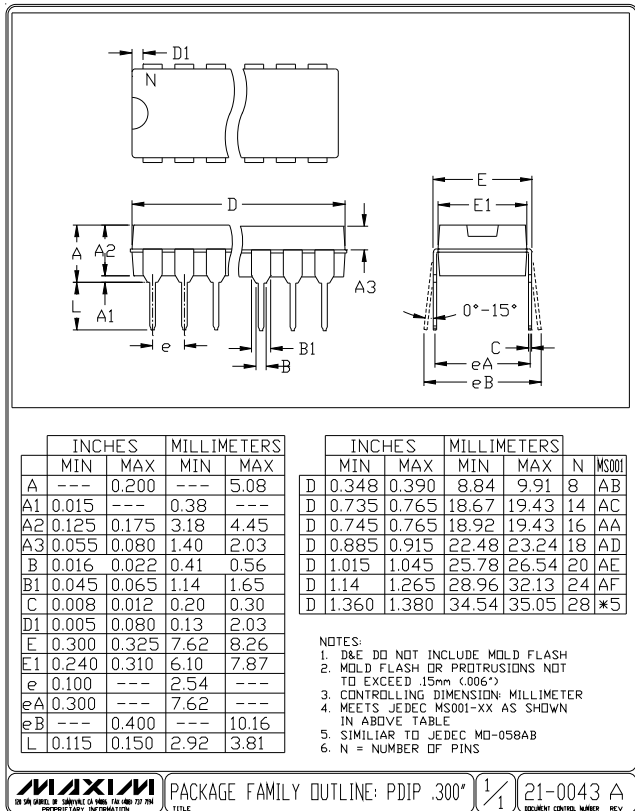

10-Bit Voltage-Output DACs in 8-Pin μ MAX

Package Information (continued)

	INCHES		MILLIMETERS	
	MIN	MAX	MIN	MAX
A	0.036	0.044	0.91	1.11
A1	0.004	0.008	0.10	0.20
B	0.010	0.014	0.25	0.36
C	0.005	0.007	0.13	0.18
D	0.116	0.120	2.95	3.05
e	0.0256		0.65	
E	0.116	0.120	2.95	3.05
H	0.188	0.198	4.78	5.03
L	0.016	0.026	0.41	0.66
α	0°	6°	0°	6°

NOTES:
 1. D&E DO NOT INCLUDE MOLD FLASH.
 2. MOLD FLASH OR PROTRUSIONS NOT TO EXCEED .15mm(.006").
 3. CONTROLLING DIMENSION: INCHES

MAXIM
 PROPRIETARY INFORMATION
 TITLE:
 8LD μ MAX PACKAGE OUTLINE DWG.
 APPROVAL: DOCUMENT CONTROL NO. 21-0036 REV D 1/1

8LUMAXDLEFS

Maxim cannot assume responsibility for use of any circuitry other than circuitry entirely embodied in a Maxim product. No circuit patent licenses are implied. Maxim reserves the right to change the circuitry and specifications without notice at any time.

16 Maxim Integrated Products, 120 San Gabriel Drive, Sunnyvale, CA 94086 (408) 737-7600

Copyright © Each Manufacturing Company.

All Datasheets cannot be modified without permission.

This datasheet has been download from :

www.AllDataSheet.com

100% Free DataSheet Search Site.

Free Download.

No Register.

Fast Search System.

www.AllDataSheet.com