



January 2003

LM4853 Boomer[®] Audio Power Amplifier Series

Mono 1.5 W / Stereo 300mW Power Amplifier

General Description

The LM4853 is an audio power amplifier capable of delivering 1.5W (typ) of continuous average power into a mono 4Ω bridged-tied load (BTL) with 1% THD+N or 95mW per channel of continuous average power into stereo 32Ω single-ended (SE) loads with 1% THD+N, using a 5V power supply. The LM4853 can automatically switch between mono BTL and stereo SE modes utilizing a headphone sense pin. It is ideal for any system that provides both a monaural speaker output and a stereo line or headphone output

Boomer audio power amplifiers were designed specifically to provide high quality output power with a minimal amount of external components. Since the LM4853 does not require bootstrap capacitors or snubber networks, it is optimally suited for low-power portable systems.

The LM4853 features an externally controlled, micropower consumption shutdown mode and thermal shutdown protection. The unity-gain stable LM4853's gain is set by external gain-setting resistors

Key Specifications

- Output Power at 1% THD+N, 1kHz:
 - LM4853LD 3Ω BTL 1.9W (typ)
 - LM4853LD 4Ω BTL 1.7W (typ)
 - LM4853MM 4Ω BTL 1.5W (typ)
 - LM4853MM,LD 8Ω BTL 1.1W (typ)
 - LM4853MM,LD 8Ω SE 300mW (typ)
 - LM4853MM,LD 32Ω SE 95mW (typ)
- THD+N at 1kHz, 95mW into 32Ω SE 1% (typ)
- Single Supply Operation 2.4 to 5.5V
- Shutdown Current 18μA (typ)

Features

- Mono 1.5W BTL or stereo 300mW output
- Headphone sense
- "Click and pop" suppression circuitry
- No bootstrap capacitors required
- Thermal shutdown protection
- Unity-gain stable
- Available in space-saving MSOP and LLP packaging

Applications

- Portable computers
- Desktop computers
- PDA's
- Handheld games

Connection Diagrams

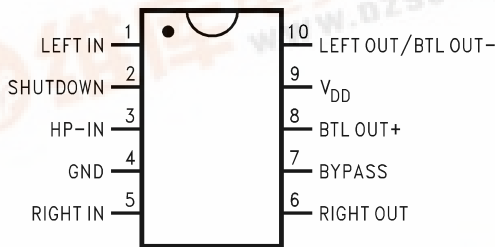

20033429

Top View
10 Lead MSOP
Order Number LM4853MM
See NS Package Number MUB10A

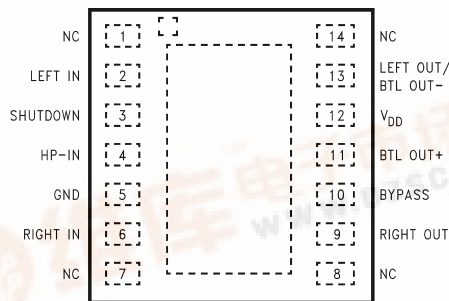

NC = NO CONNECT

20033428

Top View
14 Lead LLP
Order Number LM4853LD
See NS Package Number LDA14A

LM4853 Mono 1.5 W / Stereo 300mW Power Amplifier



Typical Application

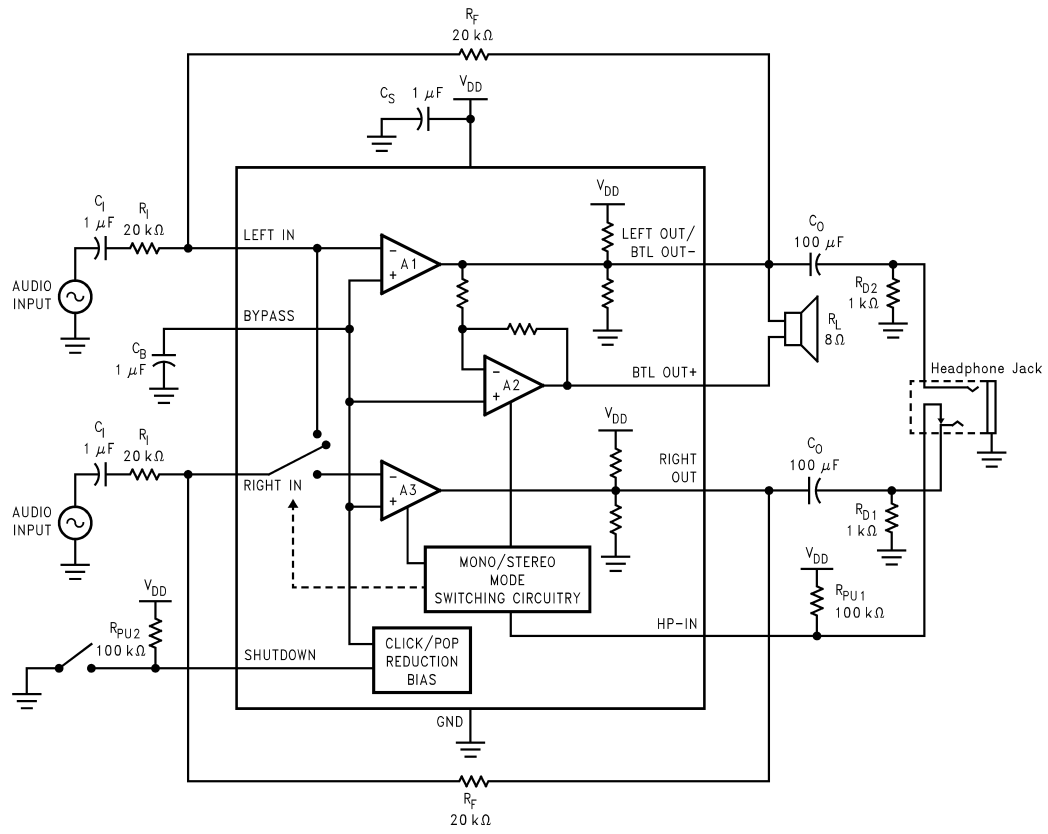

20033431

FIGURE 1. Typical Audio Amplifier Application Circuit

Absolute Maximum Ratings (Note 2)

If Military/Aerospace specified devices are required, please contact the National Semiconductor Sales Office/Distributors for availability and specifications.

Supply Voltage	6.0V
Storage Temperature	-65°C to +150°C
ESD Susceptibility (Note 4)	3.5kV
ESD Machine model (Note 7)	250V
Junction Temperature (T _J)	150°C
Solder Information (Note 1)	
Small Outline Package	
Vapor Phase (60 sec.)	215°C
Infrared (15 sec.)	220°C

Thermal Resistance

θ _{JA} (typ) — MUB10A	194°C/W
θ _{JC} (typ) — MUB10A	52°C/W
θ _{JA} (typ) — LDA14A (Note 10)	56°C/W
θ _{JC} (typ) — LDA14A	4.3°C/W

Operating Ratings (Note 2)

Temperature Range	-40°C ≤ to 85°C
Supply Voltage V _{DD}	2.4V ≤ V _{DD} ≤ 5.5V

Note 1: See AN-450 "Surface Mounting and their effects on Product Reliability" for other methods of soldering surface mount devices.

Electrical Characteristics (Notes 2, 8)

The following specifications apply for V_{DD} = 5.0V, T_A = 25°C unless otherwise specified.

Symbol	Parameter	Conditions	LM4853		Units (Limits)
			Typical (Note 5)	Limit (Note 6)	
V _{DD}	Supply Voltage			2.4	V (min)
				5.5	V (max)
I _{DD}	Supply Current	BTL Mode; V _{IN} = 0V; I _O = 0A	2.4	7.0	mA
		SE Mode; V _{IN} = 0V; I _O = 0A	2.4	7.0	mA
I _{SD}	Shutdown Current	SD Mode; V _{SHUTDOWN} = V _{DD}	18		μA
V _{OS}	Output Offset Voltage	BTL Mode; A _v = 2 BTL OUT+ to BTL OUT-	5.0	40	mV
P _O	Output Power	BTL Mode; R _L = 3Ω THD+N = 1%; LM4853LD	1.9		W
		BTL Mode; R _L = 4Ω THD+N = 1%; LM4853LD	1.7		W
		BTL Mode; R _L = 4Ω THD+N = 1%; LM4853MM	1.5		W
		BTL Mode; R _L = 8Ω THD+N = 1%; LM4853MM, LD	1.1		W
		SE Mode; R _L = 8Ω THD+N = 1%; LM4853MM, LD	300		mW
		SE Mode; R _L = 32Ω THD+N = 1%; LM4853MM, LD	95		mW
V _{IH}	Shutdown Input Voltage High	I _s < 80μA		2.0	V (min)
V _{IL}	Shutdown Input Voltage Low	I _s > 0.5mA		0.8	V (max)
Crosstalk	Channel Separation	SE Mode, R _L = 32Ω; f = 1kHz	73		dB

Electrical Characteristics (Notes 2, 8)

The following specifications apply for $V_{DD} = 3.3V$, $T_A = 25^\circ C$ unless otherwise specified.

Symbol	Parameter	Conditions	LM4853		Units (Limits)
			Typical (Note 5)	Limit (Note 6)	
I_{DD}	Supply Current	BTL Mode; $V_{IN} = 0V$; $I_O = 0A$	2.0		mA
		SE Mode; $V_{IN} = 0V$; $I_O = 0A$	2.0		mA
I_{SD}	Shutdown Current	SD Mode; $V_{SHUTDOWN} = V_{DD}$	12		μA
V_{OS}	Output Offset Voltage	BTL Mode; $A_V = 2$ BTL OUT+ to BTL OUT-	5.0	40	mV
P_O	Output Power	BTL Mode; $R_L = 8\Omega$ THD+N = 1%	440		mW
		SE Mode; $R_L = 32\Omega$ THD+N = 1%	40		mW
V_{IH}	Shutdown Input Voltage High	$I_S < 80\mu A$		2.0	V (min)
V_{IL}	Shutdown Input Voltage Low	$I_S > 0.5mA$		0.8	V (max)

Electrical Characteristics (Notes 2, 8)

The following specifications apply for $V_{DD} = 2.7V$, $T_A = 25^\circ C$ unless otherwise specified.

Symbol	Parameter	Conditions	LM4853		Units (Limits)
			Typical (Note 5)	Limit (Note 6)	
I_{DD}	Supply Current	BTL Mode; $V_{IN} = 0V$; $I_O = 0A$	1.8		mA
		SE Mode; $V_{IN} = 0V$; $I_O = 0A$	1.8		mA
I_{SD}	Shutdown Current	SD Mode; $V_{SHUTDOWN} = V_{DD}$	10		μA
V_{OS}	Output Offset Voltage	BTL Mode; $A_V = 2$ BTL OUT+ to BTL OUT-	5.0	40	mV
P_O	Output Power	BTL Mode; $R_L = 8\Omega$ THD+N = 1%	300		mW
		SE Mode; $R_L = 32\Omega$ THD+N = 1%	25		mW
V_{IH}	Shutdown Input Voltage High	$I_S < 80\mu A$		2.0	V (min)
V_{IL}	Shutdown Input Voltage Low	$I_S > 0.5mA$		0.8	V (max)

Note 2: Absolute Maximum Rating indicate limits beyond which damage to the device may occur.

Note 3: Operating Ratings indicate conditions for which the device is functional, but do not guarantee specific performance limits. For guaranteed specifications and test conditions, see the Electrical Characteristics. The guaranteed specifications apply only for the test conditions listed. Some performance characteristics may degrade when the device is not operated under the listed test conditions.

Note 4: Human body model, 100pF discharged through a 1.5k Ω resistor.

Note 5: Typical specifications are specified at +25 $^\circ C$ and represent the most likely parametric norm.

Note 6: Datasheet min/max specification limits are guaranteed by design, test, or statistical analysis.

Note 7: Machine Model ESD test is covered by specification EIAJ IC-121-1981. A 200pF cap is charged to the specified voltage, then discharged directly into the IC with no external series resistor (resistance of discharge path must be under 50 Ω).

Note 8: All voltages are measured with respect to the ground pin, unless otherwise specified.

Note 9: Limits are guaranteed to National's AOQL (Average Outgoing Quality Level).

Note 10: The given θ_{JA} is for an LM4853LD with the Exposed-DAP soldered to an exposed 1in² area of 1oz printed circuit board copper.

External Components Description

See Figure 1.

Components	Functional Description
1. R_i	Inverting input resistance which sets the closed-loop gain in conjunction with R_f . This resistor also forms a high pass filter with C_i at $f_c = 1/(2\pi R_i C_i)$.
2. C_i	Input coupling capacitor which blocks the DC voltage at the amplifier's input terminals. Also creates a highpass filter with R_i at $f_c = 1/(2\pi R_i C_i)$. Refer to the section, Proper Selection of External Components , for an explanation of how to determine the value of C_i .
3. R_f	Feedback resistance which sets the closed-loop gain in conjunction with R_i .
4. C_s	Supply bypass capacitor which provides power supply filtering. Refer to the Power Supply Bypassing section for information concerning proper placement and selection of the supply bypass capacitor.
5. C_B	Bypass pin capacitor which provides half-supply filtering. Refer to the section, Proper Selection of External Components , for information concerning proper placement and selection of C_B .
6. C_O	Output coupling capacitor which blocks the DC voltage at the amplifier's output. Forms a high pass filter with the single-ended load R_L at $f_o = 1/(2\pi R_L C_O)$.

Typical Performance Characteristics LD Specific Characteristics

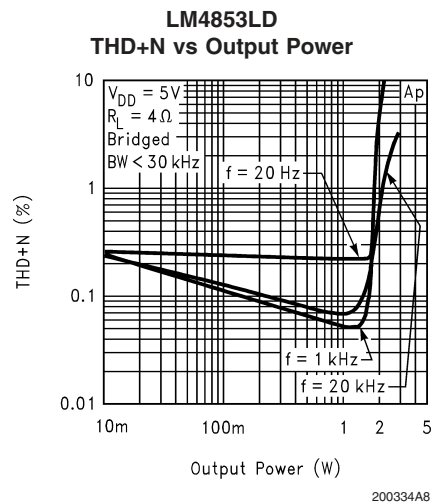
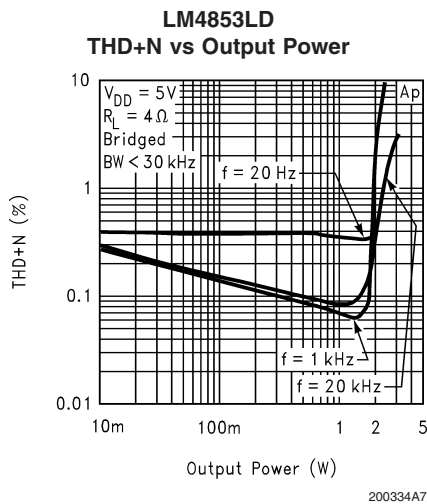
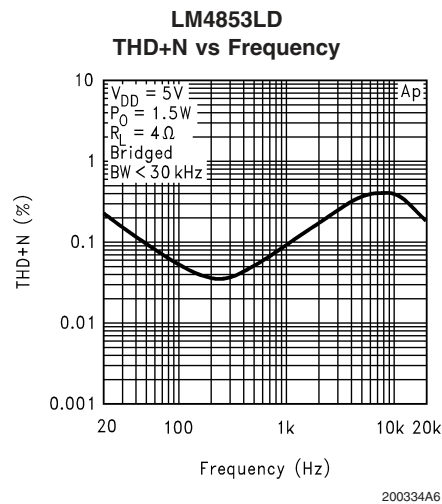
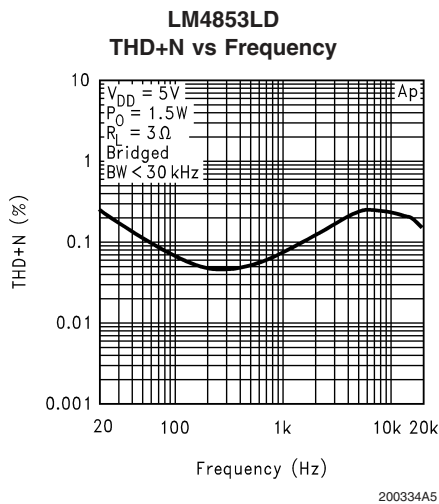

Typical Performance Characteristics LD Specific Characteristics (Continued)

**LM4853LD
Power Dissipation vs
Output Power**

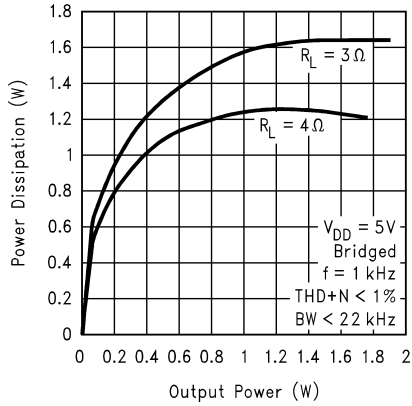

200334A9

**LM4853LD
Power Derating Curve**

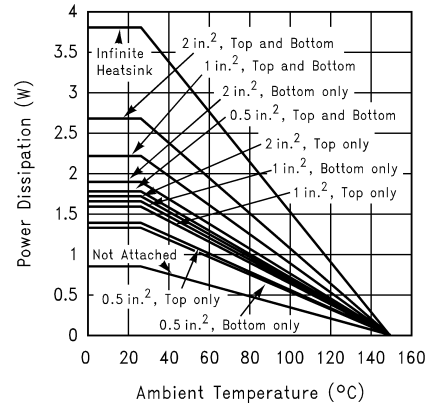

200334B0

Typical Performance Characteristics

THD+N vs Frequency

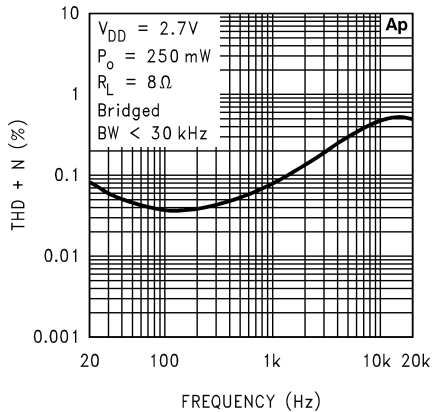

20033463

THD+N vs Frequency

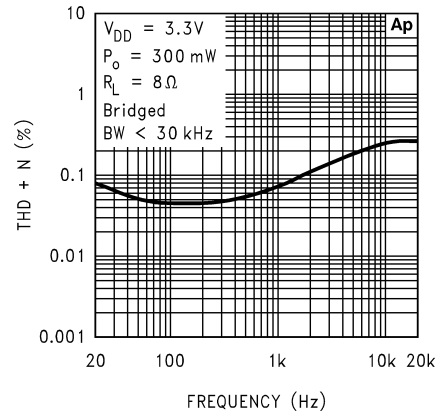

20033464

THD+N vs Frequency

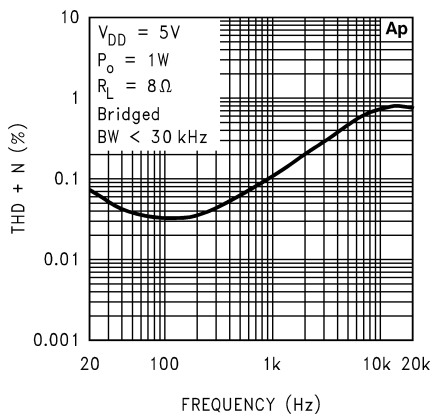

20033465

THD+N vs Frequency

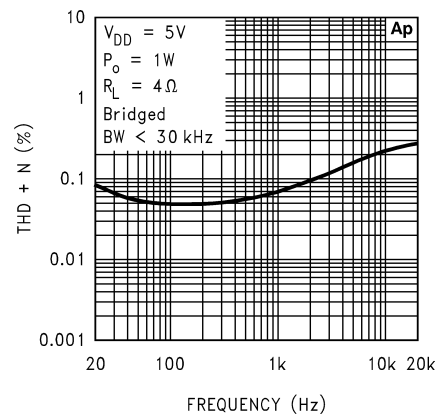

20033466

Typical Performance Characteristics (Continued)

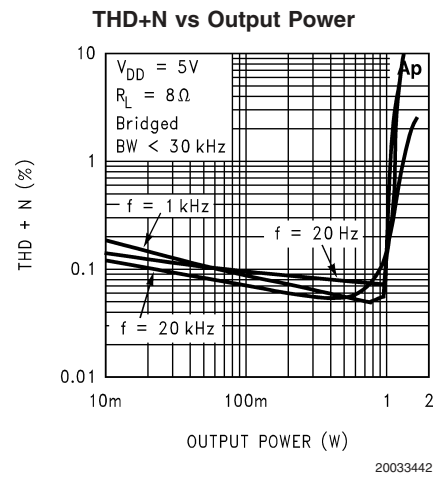
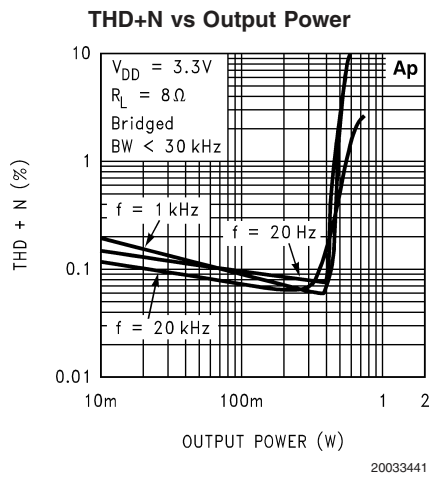
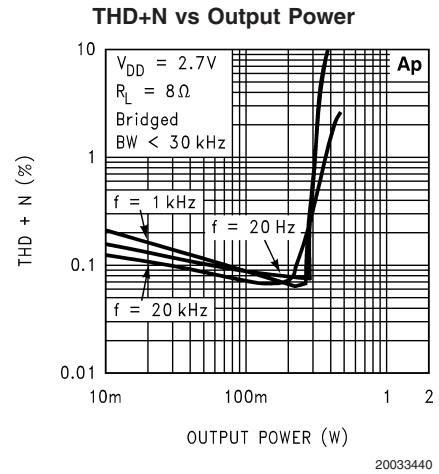
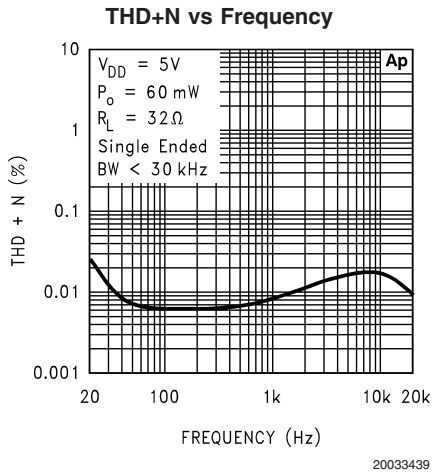
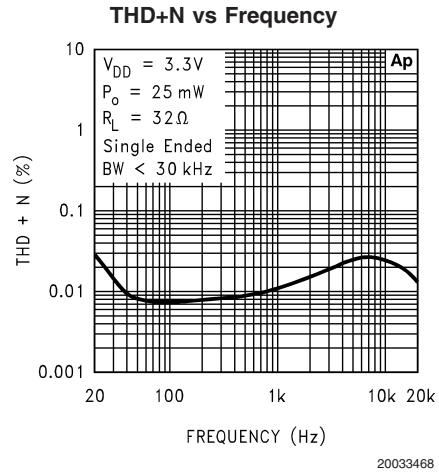
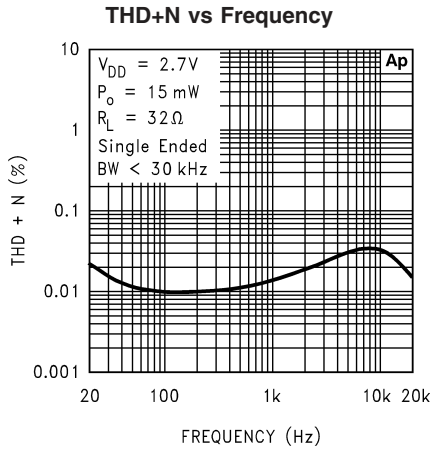

Typical Performance Characteristics (Continued)

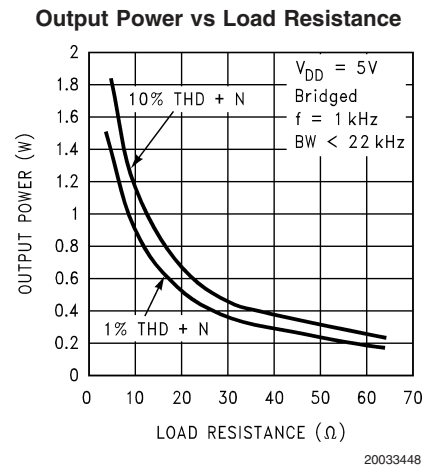
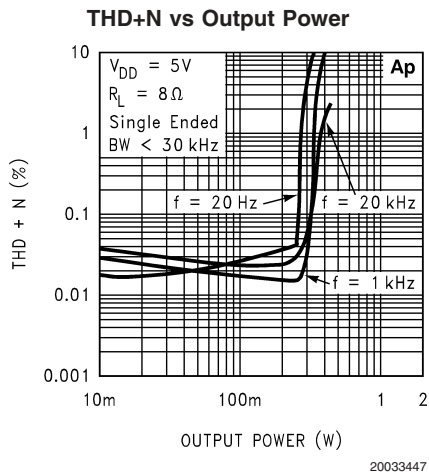
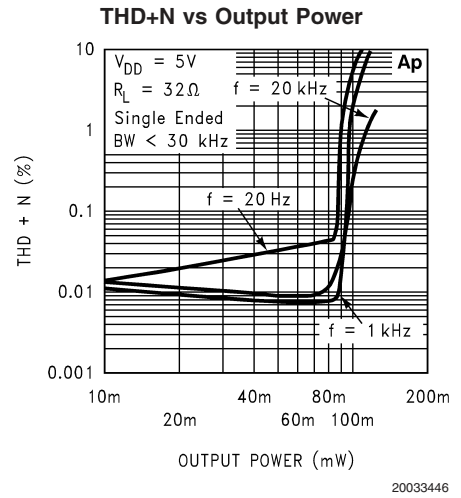
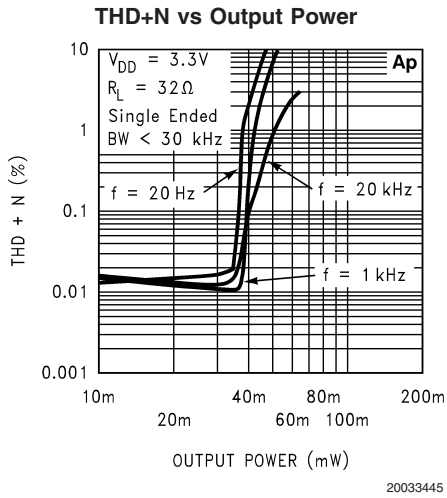
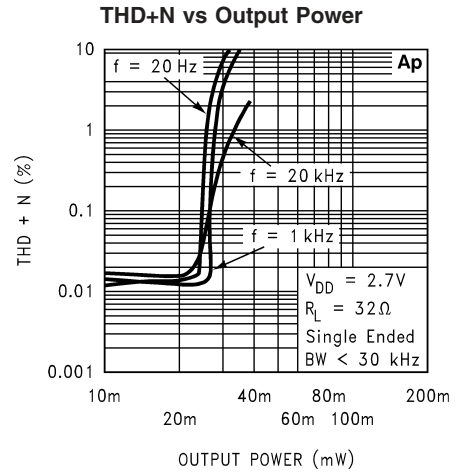
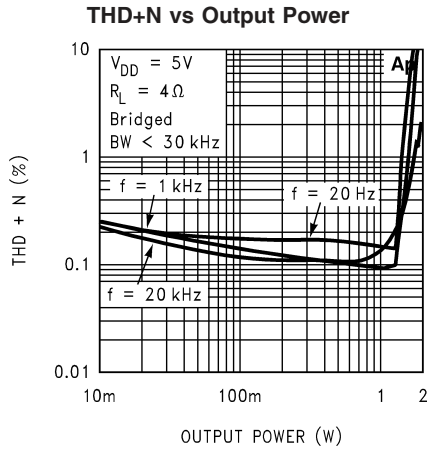

Typical Performance Characteristics (Continued)

Output Power vs Load Resistance

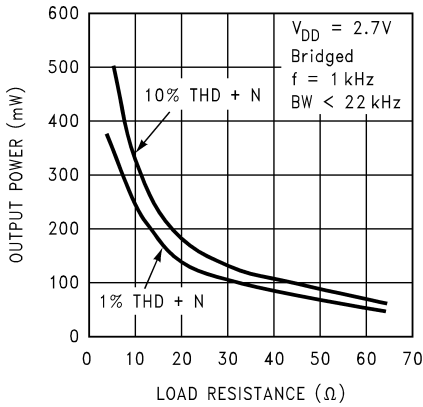

20033449

Output Power vs Supply Voltage

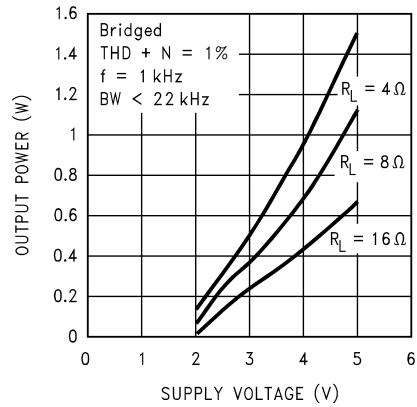

20033469

Output Power vs Supply Voltage

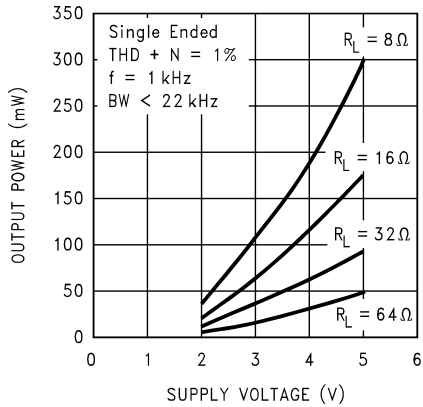

20033471

Dropout Voltage vs Supply Voltage

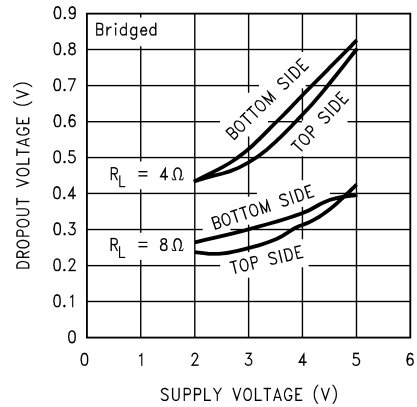

20033472

Power Dissipation vs Output Power

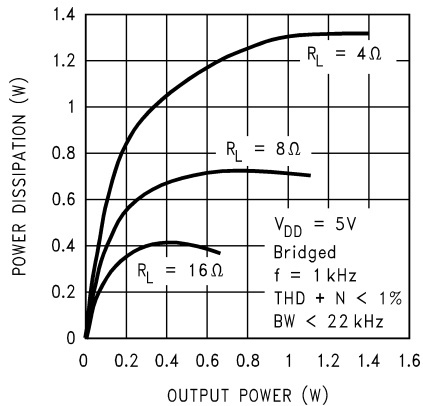

20033455

Power Dissipation vs Output Power

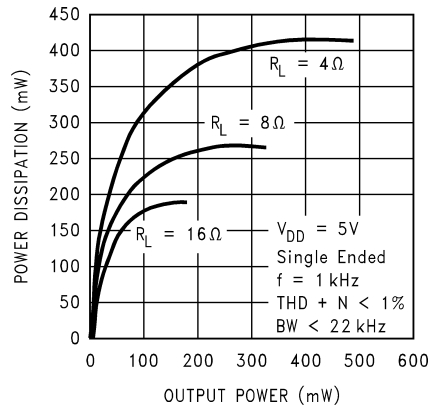

20033456

Typical Performance Characteristics (Continued)

Power Derating Curve

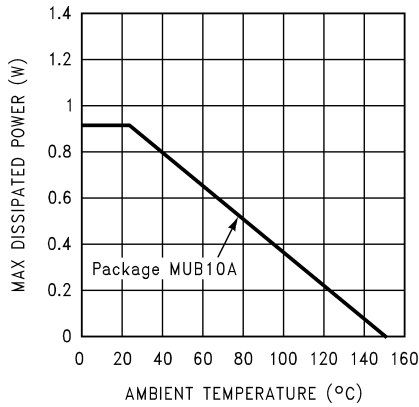

20033457

Channel Separation

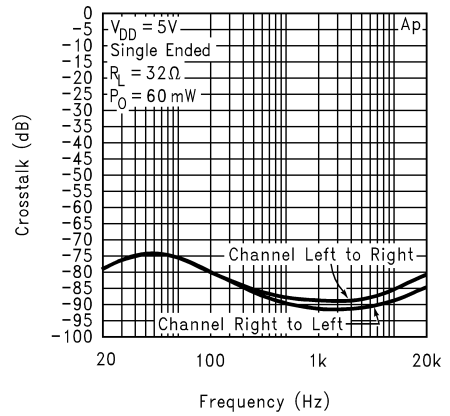

20033480

Noise Floor

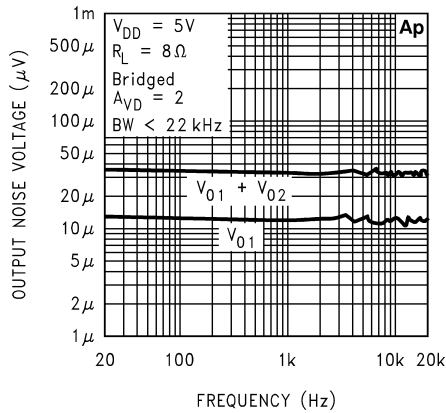

20033459

Open Loop Frequency Response

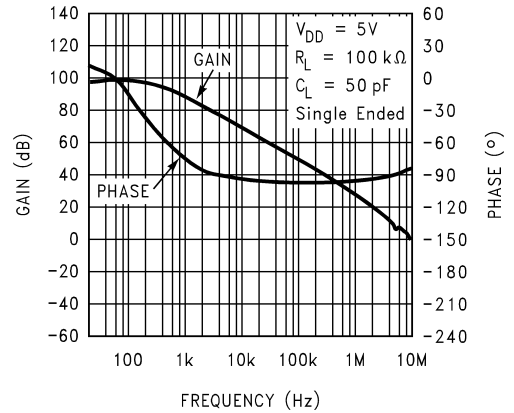

20033462

Supply Current vs Supply Voltage

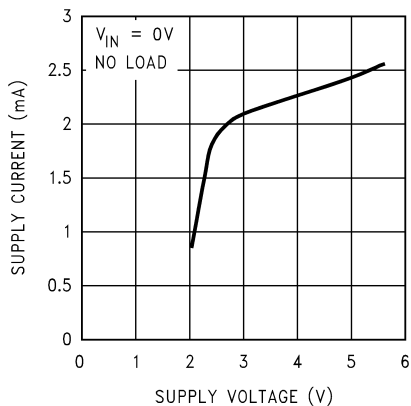

20033461

Power Supply Rejection Ratio

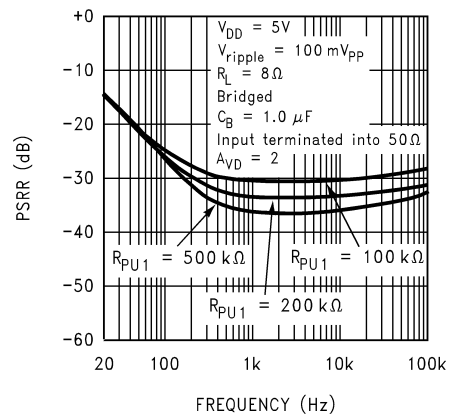

20033460

Typical Performance Characteristics (Continued)

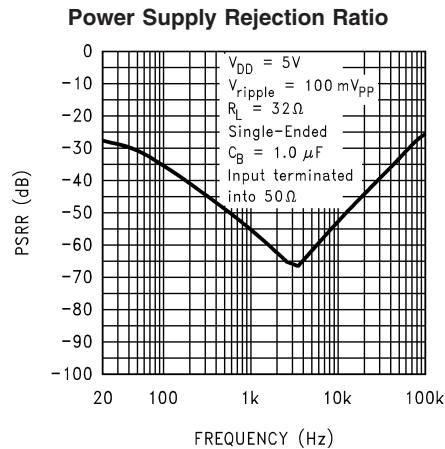

Application Information

BRIDGED AND SINGLE-ENDED OPERATION

As shown in Figure 1, the LM4853 contains three operational amplifiers (A1-A3). These amplifiers can be configured for SE or BTL modes.

In the SE mode, the LM4853 operates as a high current output dual op amp. A1 and A3 are independent amplifiers with an externally configured gain of $A_V = -R_F/R_I$. The outputs of A1 and A3 are used to drive an external set of headphones plugged into the headphone jack. Amplifier A2 is shut down to a high output impedance state in SE mode. This prevents any current flow into the mono bridge-tied load, thereby muting it.

In BTL mode, A3 is shut down to a high impedance state. The audio signal from the RIGHT IN pin is directed to the inverting input of A1. As a result, the LEFT IN and RIGHT IN audio signals, V_{INL} and V_{INR} , are summed together at the input of A1. A2 is then activated with a closed-loop gain of $A_V = -1$ fixed by two internal 20kΩ resistors. The outputs of A1 and A2 are then used to drive the mono bridged-tied load.

EXPOSED-DAP PACKAGE PCB MOUNTING CONSIDERATION

The LM4853's exposed-DAP (die attach paddle) package (LD) provides a low thermal resistance between the die and the PCB to which the part is mounted and soldered. This allows rapid heat transfer from the die to the surrounding PCB copper traces, ground plane, and surrounding air. The result is a low voltage audio power amplifier that produces 1.7W at $\leq 1\%$ THD+N with a 4Ω load. This high power is achieved through careful consideration of necessary thermal design. Failing to optimize thermal design may compromise the LM4853's high power performance and activate unwanted, though necessary, thermal shutdown protection.

The LD package must have its DAP soldered to a copper pad on the PCB. The DAP's PCB copper pad is connected to a large plane of continuous unbroken copper. This plane forms a thermal mass, heat sink, and radiation area. Place the heat sink area on either outside plane in the case of a two-sided PCB, or on an inner layer of a board with more than two layers. Connect the DAP copper pad to the inner layer or backside copper heat sink area with 4(2x2) vias. The

via diameter should be 0.012in-0.013in with a 1.27mm pitch. Ensure efficient thermal conductivity by plating through the vias.

Best thermal performance is achieved with the largest practical heat sink area. If the heatsink and amplifier share the same PCB layer, a nominal 2.5in² area is necessary for 5V operation with a 4Ω load. Heatsink areas not placed on the same PCB layer as the LM4853 should be 5in² (min) for the same supply voltage and load resistance. The last two area recommendations apply for 25°C ambient temperature. Increase the area to compensate for ambient temperatures above 25°C. The LM4853's power de-rating curve in the **Typical Performance Characteristics** shows the maximum power dissipation versus temperature. An example PCB layout for the LD package is shown in the **Demonstration Board Layout** section. Further detailed and specific information concerning PCB layout, fabrication, and mounting an LD (LLP) package is available from National Semiconductor's Package Engineering Group under application note AN1187.

BRIDGE CONFIGURATION EXPLANATION

When the LM4853 is in BTL mode, the output of amplifier A1 serves as the input to amplifier A2, which results in both amplifiers producing signals identical in magnitude, but out of phase by 180°. Consequently, the differential gain for the mono channel is:

$$A_{VD} = V_{OUT} / (V_{INL} + V_{INR}) = 2 \times (R_F / R_I) \quad (1)$$

Driving a load differentially through the BTL OUT- and BTL OUT+ outputs is an amplifier configuration commonly referred to as "bridged mode". Bridged mode operation is different from the classical single-ended amplifier configuration where one side of its load is connected to ground.

A bridge amplifier design has a few distinct advantages over the single-ended configuration. It drives a load differentially, which doubles output swing for a specified supply voltage. This produces four times the output power as that produced by a single-ended amplifier under the same conditions. This increase in attainable output power assumes that the amplifier is not current limited or clipped. In order to choose an

Application Information (Continued)

amplifier's closed-loop gain without causing excessive output signal clipping, please refer to the **Audio Power Amplifier Design** section.

A bridge configuration, such as the one used in LM4853, also creates a second advantage over single-ended amplifiers. Since the differential outputs, BTL OUT- and BTL OUT+, are biased at half-supply, no net DC voltage exists across the load. This eliminates the need for the output coupling capacitor that a single supply, single-ended amplifier configuration requires. Eliminating an output coupling capacitor in a single-ended configuration forces the half-supply bias voltage across the load. This increases internal IC power dissipation and may cause permanent loudspeaker damage.

POWER DISSIPATION

Whether the power amplifier is bridged or single-ended, power dissipation is a major concern when designing the amplifier. Equation 2 states the maximum power dissipation point for a single-ended amplifier operating at a given supply voltage and driving a specified load.

$$P_{\text{DMAX}} = (V_{\text{DD}})^2 / (2\pi^2 R_L): \text{Single-Ended} \quad (2)$$

However, a direct consequence of the increased power delivered to the load by a bridge amplifier is an increase in internal power dissipation. Equation 3 states the maximum power dissipation point for a bridge amplifier operating at the same given conditions.

$$P_{\text{DMAX}} = 4 \times (V_{\text{DD}})^2 / (2\pi^2 R_L): \text{Bridge Mode} \quad (3)$$

The LM4853 is designed to drive either two single-ended loads simultaneously or one mono bridged-tied load. In SE mode, the maximum internal power dissipation is 2 times that of Equation 2. In BTL mode, the maximum internal power dissipation is the result of Equation 3. Even with this substantial increase in power dissipation, the LM4853 does not require heatsinking. The power dissipation from Equation 3 must not be greater than the power dissipation predicted by Equation 4:

$$P_{\text{DMAX}} = (T_{\text{JMAX}} - T_A) / \theta_{\text{JA}} \quad (4)$$

For the package MUB10A, $\theta_{\text{JA}} = 194^\circ\text{C/W}$. $T_{\text{JMAX}} = 150^\circ\text{C}$ for the LM4853. Depending on the ambient temperature, T_A , of the surroundings, Equation 4 can be used to find the maximum internal power dissipation supported by the IC packaging. If the result of Equation 3 is greater than that of Equation 4, then either the supply voltage must be decreased, the load impedance increased, or the ambient temperature reduced. For the typical application of a 5V power supply, and an 8 Ω bridged load, the maximum ambient temperature possible without violating the maximum junction temperature is approximately 27 $^\circ\text{C}$ for package MUB10A. This assumes the device operates at maximum power dissipation and uses surface mount packaging. Internal power dissipation is a function of output power. If typical operation is not around the maximum power dissipation point, operation at higher ambient temperatures is possible. Refer to the **Typical Performance Characteristics** curves for power dissipation information for different output power levels.

POWER SUPPLY BYPASSING

As with any power amplifier, proper supply bypassing is critical for low noise performance and high power supply rejection. The capacitor location on both the bypass and power supply pins should be as close to the device as possible. The value of the pin bypass capacitor, C_B , directly affects the LM4853's half-supply voltage stability and PSRR. The stability and supply rejection increase as the bypass capacitor's value increases. Typical applications employ a 5V regulator with a 10 μF and a 0.1 μF bypass capacitors which aid in supply filtering. This does not eliminate the need for bypassing the supply nodes of the LM4853. The selection of bypass capacitors, especially C_B , is thus dependent upon desired PSRR requirements, click and pop performance, system cost, and size constraints.

SHUTDOWN FUNCTION

In order to reduce power consumption while not in use, the LM4853 features amplifier bias circuitry shutdown. This shutdown function is activated by applying a logic high to the SHUTDOWN pin. The trigger point is 2.0V minimum for a logic high level, and 0.8V maximum for a logic low level. It is best to switch between ground and the supply, V_{DD} , to ensure correct shutdown operation. By switching the SHUTDOWN pin to V_{DD} , the LM4853 supply current draw will be minimized in idle mode. Whereas the device will be disabled with shutdown voltages less than V_{DD} , the idle current may be greater than the typical value of 18 μA . In either case, the SHUTDOWN pin should be tied to a fixed voltage to avoid unwanted state changes.

In many applications, a microcontroller or microprocessor output is used to control the shutdown circuitry. This provides a quick, smooth shutdown transition. Another solution is to use a single-pole, single-throw switch in conjunction with an external pull-up resistor. When the switch is closed, the SHUTDOWN pin is connected to ground and enables the amplifier. If the switch is open, the external pull-up resistor, R_{PU2} will disable the LM4853. This scheme guarantees that the SHUTDOWN pin will not float, thus preventing unwanted state changes.

HP-IN FUNCTION

The LM4853 features a headphone control pin, HP-IN, that enables the switching between BTL and SE modes. A logic-low to HP-IN activates the BTL mode, while a logic-high activates the SE mode.

Figure 2 shows the implementation of the LM4853's headphone control. The voltage divider formed by R_{PU1} and R_{D1} sets the voltage at HP-IN to be approximately 50mV with no headphones plugged into the system. This logic-low voltage at the HP-IN pin enables the BTL mode

When a set of headphones is plugged into the system, the headphone jack's contact pin is disconnected from the signal pin. This also interrupts the voltage divider set up by the resistors R_{PU1} and R_{D1} . Resistor R_{PU1} applies V_{DD} to the HP-IN pin, switching the LM4853 out of BTL mode and into SE mode. The amplifier then drives the headphones, whose impedance is in parallel with resistors R_{D1} and R_{D2} . Resistors R_{D1} and R_{D2} have negligible effect on the output drive capability since the typical impedance of headphones is 32 Ω .

Application Information (Continued)

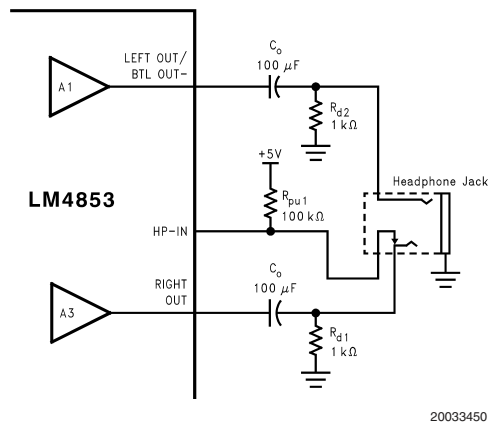

FIGURE 2. Headphone Control Circuit

Also shown in *Figure 2* are the electrical connections for the headphone jack and plug. A 3-wire plug consists of a Tip, Ring, and Sleeve, where the Tip and Ring are audio signal conductors and the Sleeve is the common ground return. One control pin for each headphone jack is sufficient to indicate to the control inputs that a user has inserted a plug into the jack and that the headphone mode of operation is desired.

To ensure smooth transition from BTL to SE operation, it is important to connect HP-IN and R_{PU1} to the control pin on the Right Output of the headphone jack. The control pin on the Left Output of the headphone jack should be left open. Connecting the node between the HP-IN and R_{PU1} to the Left Output control pin may cause unwanted state changes to the HP-IN pin.

PROPER SELECTION OF EXTERNAL COMPONENTS

Proper selection of external components in applications using integrated power amplifiers is critical for optimum device and system performance. While the LM4853 is tolerant to a variety of external component combinations, consideration must be given to the external component values that maximize overall system quality.

The LM4853's unity-gain stability allows a designer to maximize system performance. The LM4853's gain should be set no higher than necessary for any given application. A low gain configuration maximizes signal-to-noise performance and minimizes THD+N. However, a low gain configuration also requires large input signals to obtain a given output power. Input signals equal to or greater than $1V_{RMS}$ are available from sources such as audio codecs. Please refer to the section, **Audio Power Amplifier Design**, for a more complete explanation of proper gain selection.

Selecting Input and Output Capacitor Values

Besides gain, one of the major considerations is the closed-loop bandwidth of the amplifier. To a large extent, the bandwidth is dictated by the choice of external components shown in *Figure 1*. The input coupling capacitor C_i and resistor R_i form a first order high pass filter that limits low frequency response. C_i 's value should be based on the desired frequency response weighed against the following: Large value input and output capacitors are both expensive and space consuming for portable designs. Clearly a certain

sized capacitor is needed to couple in low frequencies without severe attenuation. But in many cases the speakers used in portable systems, whether internal or external, have little ability to reproduce signals below 150Hz. Thus, large value input and output capacitors may not increase system performance.

AUDIO POWER AMPLIFIER DESIGN

Design a 1W / 8Ω Bridged Audio Amplifier

Given:

- Power Output: $1W_{RMS}$
- Load Impedance: 8Ω
- Input Level: $1V_{RMS}$
- Input Impedance: $20k\Omega$
- Bandwidth: $100Hz - 20kHz \pm 0.25dB$

A designer must first determine the minimum supply voltage needed to obtain the specified output power. By extrapolating from the Output Power vs Supply Voltage graphs in the **Typical Performance Characteristics** section, the supply rail can be easily found. A second way to determine the minimum supply rail is to calculate the required V_{OPEAK} using Equation 5 and add the dropout voltage. This results in Equation 6, where V_{ODTOP} and V_{ODBOT} are extrapolated from the Dropout Voltage vs Supply Voltage curve in the **Typical Performance Characteristics** section.

$$V_{OPEAK} = \sqrt{2 R_L P_O} \quad (5)$$

$$V_{DD} \geq (V_{OPEAK} + (V_{ODTOP} + V_{ODBOT})) \quad (6)$$

Using the Output Power vs Supply Voltage graph for an 8Ω load, the minimum supply rail is 4.7V. But since 5V is a standard supply voltage in most applications, it is chosen for the supply rail. Extra supply voltage creates headroom that allows the LM4853 to reproduce peaks in excess of 1W without producing audible distortion. However, the designer must make sure that the chosen power supply voltage and output load does not violate the conditions explained in the **Power Dissipation** section.

Once the power dissipation equations have been addressed, the required differential gain can be determined from Equation 7.

$$A_{VD} \geq \sqrt{P_O R_L} / (V_{IN}) = V_{ORMS} / V_{INRMS} \quad (7)$$

$$R_F / R_I = A_{VD} / 2 \quad (8)$$

From Equation 6, the minimum A_{VD} is 2.83; use $A_{VD} = 3$.

The desired input impedance was 20kΩ, and with an A_{VD} of 3, using Equation 8 results in an allocation of $R_I = 20k\Omega$ and $R_F = 30k\Omega$.

The final design step is to set the amplifier's -3dB frequency bandwidth. To achieve the desired $\pm 0.25dB$ pass band magnitude variation limit, the low frequency response must extend to at least one-fifth the lower bandwidth limit and the high frequency response must extend to at least five times

Application Information (Continued)

the upper bandwidth limit. The variation for both response limits is 0.17dB, well within the ± 0.25 dB desired limit. This results in:

$$f_L = 100\text{Hz} / 5 = 20\text{Hz}$$

$$f_H = 20\text{kHz} \times 5 = 100\text{kHz}$$

As stated in the **External Components** section, R_i in conjunction with C_i create a highpass filter. Find the coupling capacitor's value using Equation 9.

$$C_i \geq 1 / (2\pi R_i f_L) \quad (9)$$

$$C_i \geq 1 / (2\pi \times 20\text{k}\Omega \times 20\text{Hz}) = 0.397\mu\text{F}$$

Use a 0.39 μ F capacitor, the closest standard value.

The high frequency pole is determined by the product of the desired high frequency pole, f_H , and the differential gain, A_{VD} . With $A_{VD} = 3$ and $f_H = 100\text{kHz}$, the resulting GBWP = 150kHz which is much smaller than the LM4853 GBWP of 10MHz. This difference indicates that a designer can still use the LM4853 at higher differential gains without bandwidth limitations.

PCB LAYOUT AND SUPPLY REGULATION CONSIDERATIONS FOR DRIVING 3 Ω AND 4 Ω LOADS

Power dissipated by a load is a function of the voltage swing across the load and the load's impedance. As load impedance decreases, load dissipation becomes increasingly de-

pendant on the interconnect (PCB trace and wire) resistance between the amplifier output pins and the load's connections. Residual trace resistance causes a voltage drop, which results in power dissipated in the trace and not in the load as desired. For example, 0.1 Ω trace resistance reduces the output power dissipated by a 4 Ω load from 2.0W to 1.95W. This problem of decreased load dissipation is exacerbated as load impedance decreases. Therefore, to maintain the highest load dissipation and widest output voltage swing, PCB traces that connect the output pins to a load must be as wide as possible.

Poor power supply regulation adversely affects maximum output power. A poorly regulated supply's output voltage decreases with increasing load current. Reduced supply voltage causes decreased headroom, output signal clipping, and reduced output power. Even with tightly regulated supplies, trace resistance creates the same effects as poor supply regulation. Therefore, making the power supply traces as wide as possible helps maintain full output voltage swing.

Demonstration Board Layout

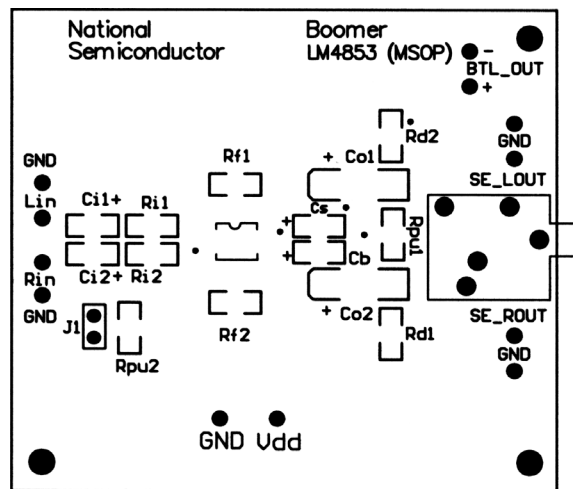

200394A1

FIGURE 3. Recommended MM PC Board Layout: Component-Side SilkScreen

Demonstration Board Layout (Continued)

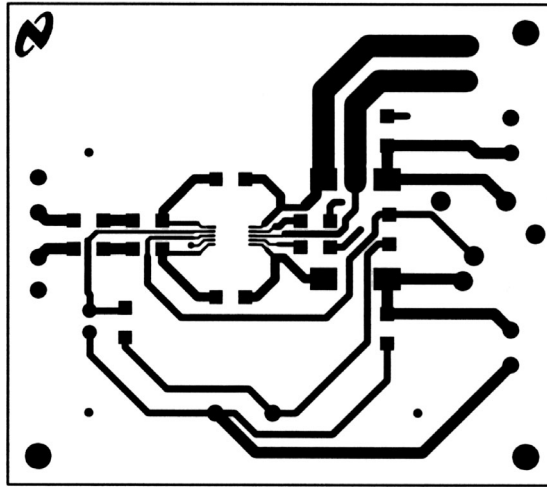

200334A2

FIGURE 4. Recommended MM PC Board Layout:
Component-Side Layout

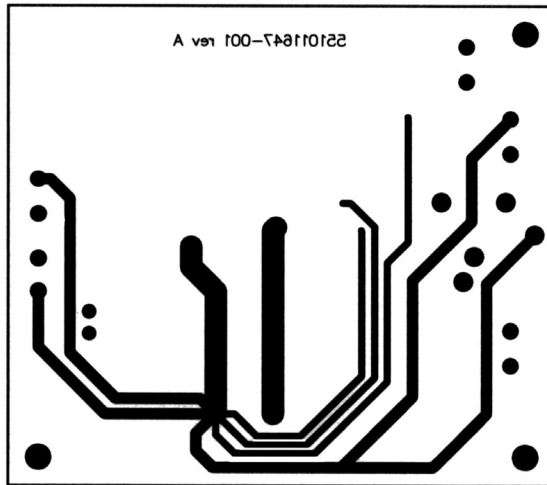

200334A3

FIGURE 5. Recommended MM PC Board Layout:
Bottom-Side Layout

Physical Dimensions inches (millimeters) unless otherwise noted

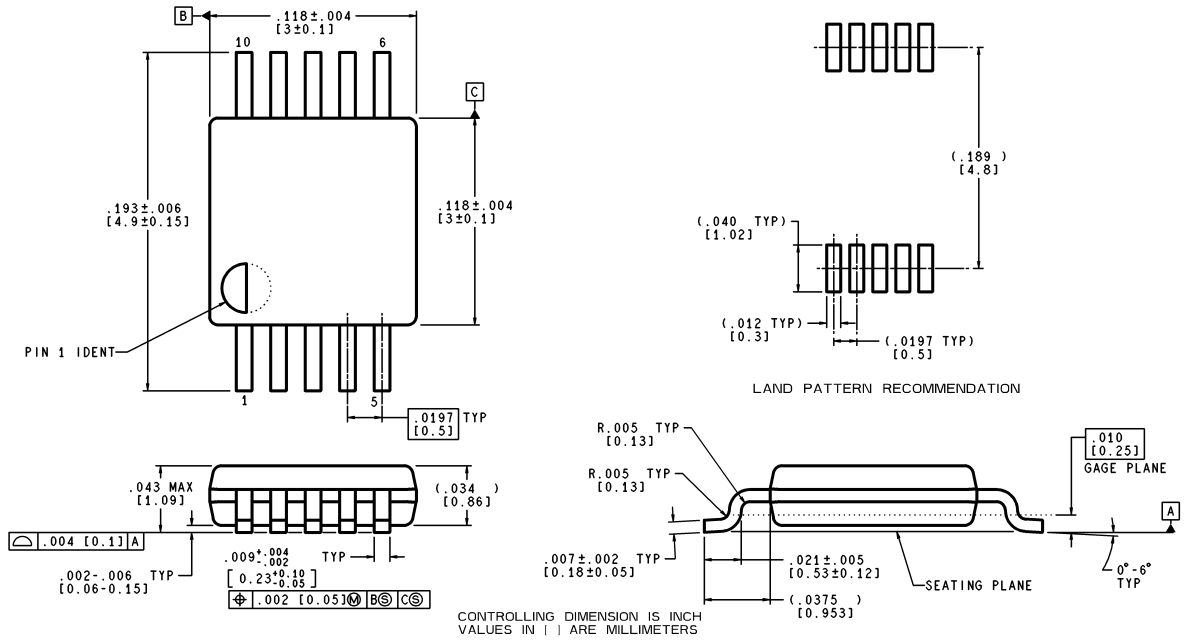

MUB10A (Rev A)

10-Lead Mini SOIC, 118 Mil Wide, .5mm Pitch PKG
Order Number LM4853MM
NS Package Number MUB10A

Physical Dimensions inches (millimeters) unless otherwise noted (Continued)

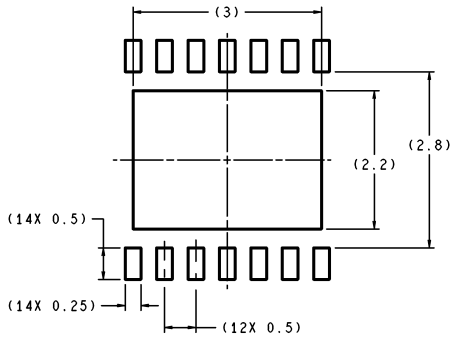

DIMENSIONS ARE IN MILLIMETERS

RECOMMENDED LAND PATTERN
1:1 RATION WITH PKG SOLDER PADS

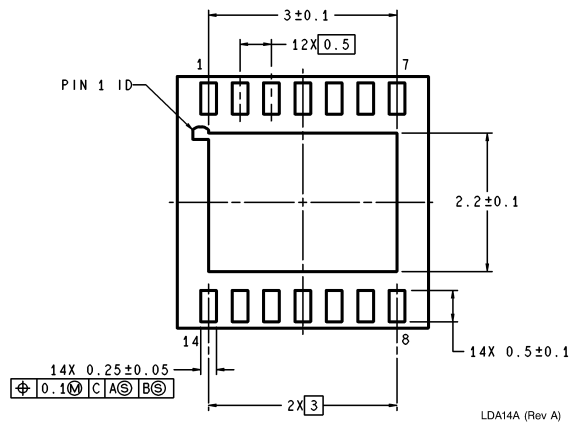
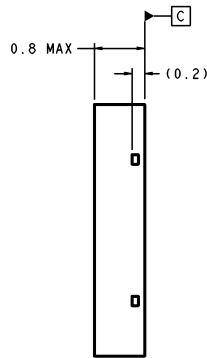
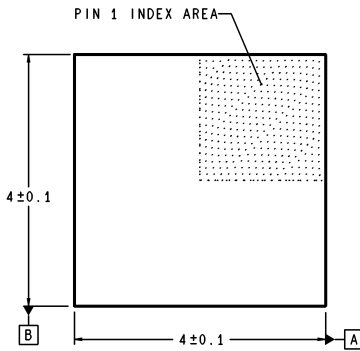

14-Lead LLP, 118 Mil Wide, .8mm Pitch PKG
Order Number LM4853LD
NS Package Number LDA14A

LIFE SUPPORT POLICY

NATIONAL'S PRODUCTS ARE NOT AUTHORIZED FOR USE AS CRITICAL COMPONENTS IN LIFE SUPPORT DEVICES OR SYSTEMS WITHOUT THE EXPRESS WRITTEN APPROVAL OF THE PRESIDENT AND GENERAL COUNSEL OF NATIONAL SEMICONDUCTOR CORPORATION. As used herein:

1. Life support devices or systems are devices or systems which, (a) are intended for surgical implant into the body, or (b) support or sustain life, and whose failure to perform when properly used in accordance with instructions for use provided in the labeling, can be reasonably expected to result in a significant injury to the user.
2. A critical component is any component of a life support device or system whose failure to perform can be reasonably expected to cause the failure of the life support device or system, or to affect its safety or effectiveness.



National Semiconductor
Americas Customer
Support Center
Email: new.feedback@nsc.com
Tel: 1-800-272-9959

www.national.com

National Semiconductor
Europe Customer Support Center
Fax: +49 (0) 180-530 85 86
Email: europe.support@nsc.com
Deutsch Tel: +49 (0) 69 9508 6208
English Tel: +44 (0) 870 24 0 2171
Français Tel: +33 (0) 1 41 91 9740

National Semiconductor
Asia Pacific Customer
Support Center
Fax: 65-6250 4466
Email: ap.support@nsc.com
Tel: 65-6254 4466

National Semiconductor
Japan Customer Support Center
Fax: 81-3-5639-7507
Email: nsj.crc@jksmtp.nsc.com
Tel: 81-3-5639-7560