

> Features

- High Speed Switching
- Low On-Resistance
- No Secondary Breakdown
- Low Driving Power
- High Voltage
- VGS = ± 30V Guarantee
- Repetitive Avalanche Rated

> Applications

- Switching Regulators
- UPS
- DC-DC converters
- General Purpose Power Amplifier

> Outline Drawing

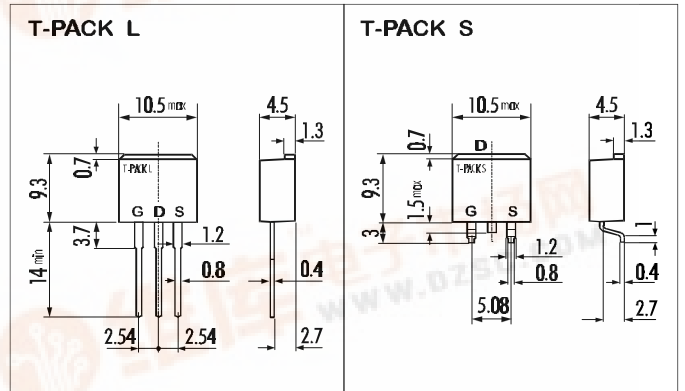

> Maximum Ratings and Characteristics

- Absolute Maximum Ratings (TC=25°C), unless otherwise specified

Item	Symbol	Rating	Unit
Drain-Source-Voltage	V _{DS}	450	V
Continous Drain Current	I _D	10	A
Pulsed Drain Current	I _{D(puls)}	40	A
Gate-Source-Voltage	V _{GS}	±30	V
Repetitive or Non-Repetitive (T _{ch} ≤ 150°C)	I _{AR}	10	A
Avalanche Energy	E _{AS}	181	mJ
Max. Power Dissipation	P _D	80	W
Operating and Storage Temperature Range	T _{ch}	150	°C
	T _{stg}	-55 ~ +150	°C

> Equivalent Circuit

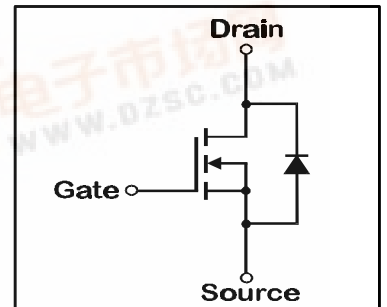

- Electrical Characteristics (TC=25°C), unless otherwise specified

Item	Symbol	Test conditions	Min.	Typ.	Max.	Unit
Drain-Source Breakdown-Voltage	V _{(BR)DSS}	I _D =1mA V _{GS} =0V	450			V
Gate Threshold Voltage	V _{GS(th)}	I _D =1mA V _{DS} =V _{GS}	3,5	4,0	4,5	V
Zero Gate Voltage Drain Current	I _{DSS}	V _{DS} =450V T _{ch} =25°C		10	500	μA
		V _{GS} =0V T _{ch} =125°C		0,2	1,0	mA
Gate Source Leakage Current	I _{GSS}	V _{GS} =±30V V _{DS} =0V		10	100	nA
Drain Source On-State Resistance	R _{DS(on)}	I _D =5A V _{GS} =10V		0,58	0,65	Ω
Forward Transconductance	g _{fs}	I _D =5A V _{DS} =25V	3	6		S
Input Capacitance	C _{iss}	V _{DS} =25V		950	1450	pF
Output Capacitance	C _{oss}	V _{GS} =0V		180	270	pF
Reverse Transfer Capacitance	C _{rss}	f=1MHz		80	120	pF
Turn-On-Time t _{on} (t _{on} =t _{d(on)} +t _r)	t _{d(on)}	V _{CC} =300V		25	40	ns
	t _r	I _D =10A		70	110	ns
Turn-Off-Time t _{off} (t _{off} =t _{d(off)} +t _f)	t _{d(off)}	V _{GS} =10V		70	110	ns
	t _f	R _{GS} =10 Ω		50	80	ns
Avalanche Capability	I _{AV}	L = 100μH T _{ch} =25°C	10			A
Diode Forward On-Voltage	V _{SD}	I _F =2I _{DR} V _{GS} =0V T _{ch} =25°C		1,1	1,65	V
Reverse Recovery Time	t _{rr}	I _F =I _{DR} V _{GS} =0V		400		ns
Reverse Recovery Charge	Q _{rr}	-di _F /dt=100A/μs T _{ch} =25°C		5,0		μC

- Thermal Characteristics

Item	Symbol	Test conditions	Min.	Typ.	Max.	Unit
Thermal Resistance	R _{th(ch-a)}	channel to air			75	°C/W
	R _{th(ch-c)}	channel to case			1,56	°C/W



N-channel MOS-FET			
450V	0,65Ω	10A	80W

2SK2754-01L,S

FAP-IIS Series



> Characteristics

Typical Output Characteristics
 $I_D = f(V_{DS})$; 80μs pulse test; $T_{ch}=25^\circ\text{C}$

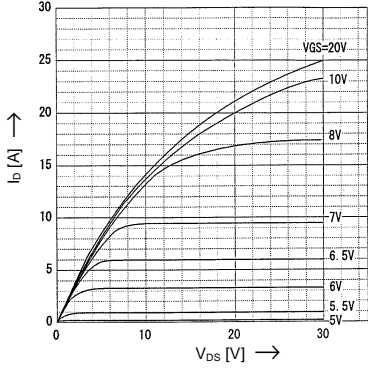

Drain-Source On-State Resistance vs. T_{ch}
 $R_{DS(on)} = f(T_{ch})$; $I_D=5\text{A}$; $V_{GS}=10\text{V}$

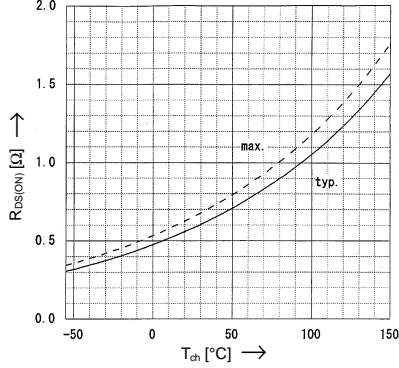

Typical Transfer Characteristics
 $I_D = f(V_{GS})$; 80μs pulse test; $V_{DS}=25\text{V}$; $T_{ch}=25^\circ\text{C}$

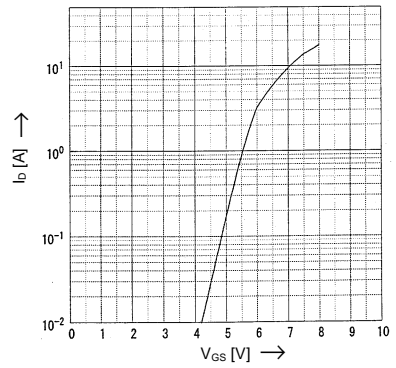

Typical Drain-Source On-State-Resistance vs. I_D
 $R_{DS(on)} = f(I_D)$; 80μs pulse test; $T_{ch}=25^\circ\text{C}$

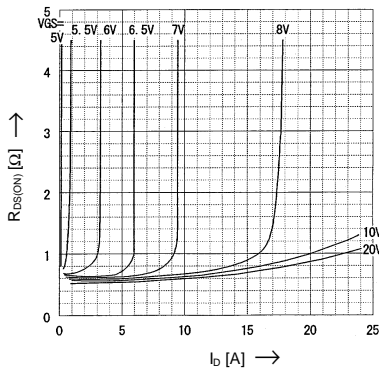

Typical Forward Transconductance vs. I_D
 $g_m = f(I_D)$; 80μs pulse test; $V_{DS}=25\text{V}$; $T_{ch}=25^\circ\text{C}$

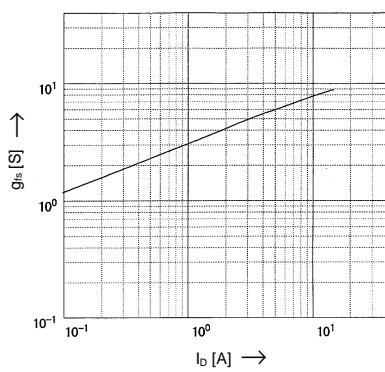

Gate Threshold Voltage vs. T_{ch}
 $V_{GS(th)} = f(T_{ch})$; $I_D=1\text{mA}$; $V_{DS}=V_{GS}$

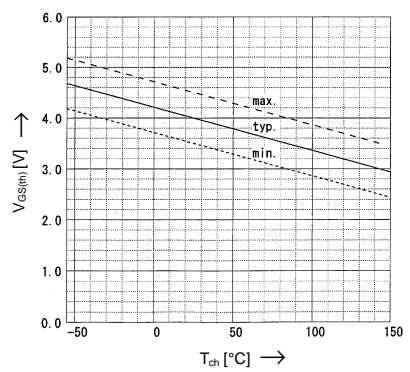

Typical Capacitances vs. V_{DS}
 $C = f(V_{DS})$; $V_{GS}=0\text{V}$; $f=1\text{MHz}$

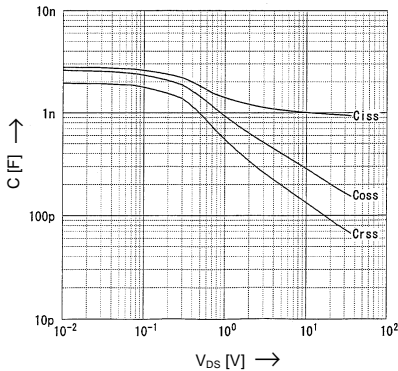

Typical Gate Charge Characteristic
 $V_{GS} = f(Q_g)$; $I_D=10\text{A}$; $T_{ch}=25^\circ\text{C}$

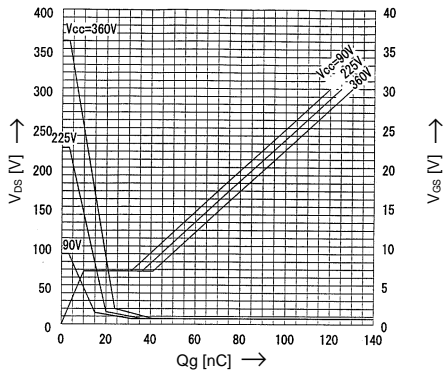

Forward Characteristics of Reverse Diode
 $I_F = f(V_{SD})$; 80μs pulse test; $V_{GS}=0\text{V}$

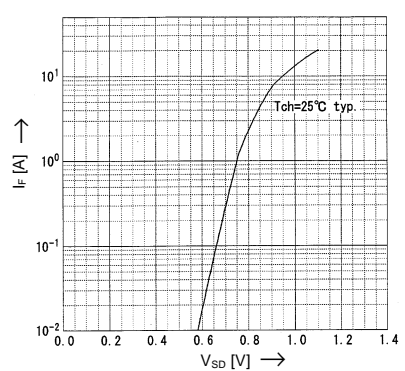

Avalanche Energy Derating
 $E_{as} = f(\text{starting } T_{ch})$; $V_{CC}=45\text{V}$; $I_{AV}=10\text{A}$

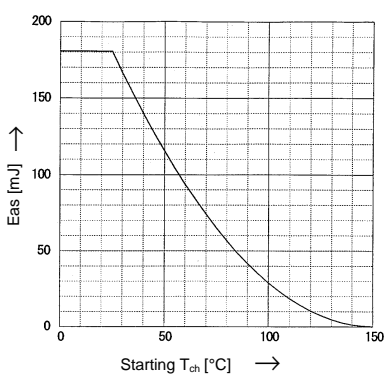

Safe Operation Area
 $I_D = f(V_{DS})$; $D=0,01$; $T_{ch}=25^\circ\text{C}$

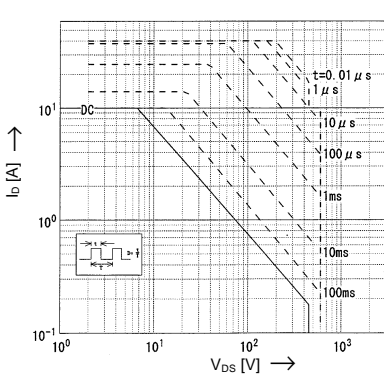

Transient Thermal Impedance
 $Z_{th(jc)} = f(t)$ parameter: $D=t/T$

