



LT1457

Dual, Precision JFET Input Op Amp

FEATURES

- Handles 10,000pF Capacitive Load
- 450 μ V Max Offset Voltage
- 1200 μ V Max Offset Voltage in S8 Package
- 50pA Bias Current at 70°C
- 13nV/ $\sqrt{\text{Hz}}$ Voltage Noise
- 4V/ μ s Slew Rate
- 4 μ V/ $^{\circ}$ C Drift
- 130dB Channel Separation

APPLICATIONS

- Sample-and-Hold (Drives Large Hold Capacitors)
- A/D and D/A Converters
- Photodiode Amplifiers
- Voltage-to-Frequency Converters

DESCRIPTION

The LT1457 is a dual, JFET input op amp optimized for handling large capacitive loads in combination with precision performance.

Precision specifications include 220 μ V offset voltage in plastic and surface mount packages. At 70°C input bias current is 50pA, input offset current is 20pA. Channel separation is 130dB.

Other dual JFET input op amps from Linear Technology include the LT1057, which is three times faster than the LT1457 but at the expense of significantly lower capacitive load handling capability; and the LT1113 with 4.5nV/ $\sqrt{\text{Hz}}$ voltage noise.

TYPICAL PERFORMANCE CHARACTERISTICS

Capacitive Load Handling

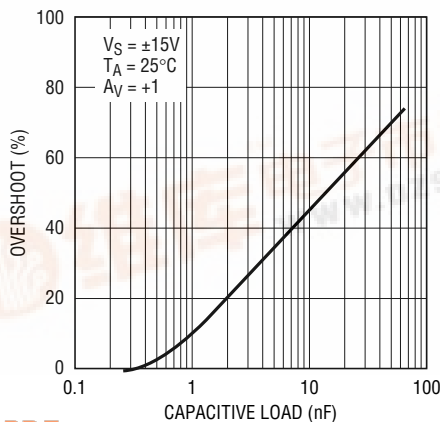

LT1457*TA01

Input Offset Voltage Distribution S8 Package

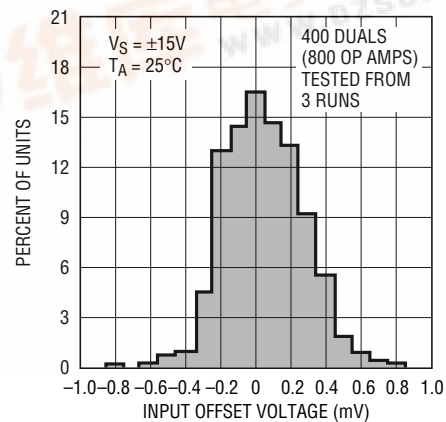

LT1457*TA02



LT1457

ABSOLUTE MAXIMUM RATINGS

Supply Voltage	$\pm 20V$
Differential Input Voltage	$\pm 40V$
Input Voltage	Equal to Supply Voltages
Output Short-Circuit Duration	Indefinite
Operating Temperature Range	$-40^{\circ}C$ to $85^{\circ}C$
Storage Temperature Range	$-65^{\circ}C$ to $150^{\circ}C$
Lead Temperature (Soldering, 10 sec)	$300^{\circ}C$

PACKAGE/ORDER INFORMATION

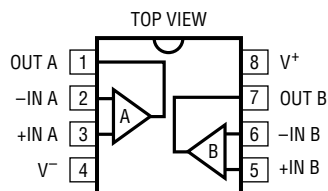
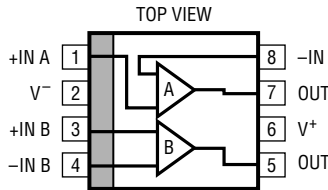
 <p>TOP VIEW</p> <p>N8 PACKAGE 8-LEAD PLASTIC DIP $T_{JMAX} = 115^{\circ}C$, $\theta_{JA} = 130^{\circ}C/W$</p>	ORDER PART NUMBER
	LT1457ACN8 LT1457CN8
 <p>TOP VIEW</p> <p>S8 PACKAGE 8-LEAD PLASTIC SOIC NOTE: THIS PIN CONFIGURATION DIFFERS FROM THE 8-LEAD DIP PIN LOCATIONS. INSTEAD, IT FOLLOWS THE INDUSTRY STANDARD LT1013DS8 SO PACKAGE CONFIGURATION. $T_{JMAX} = 130^{\circ}C$, $\theta_{JA} = 190^{\circ}C/W$</p>	LT1457S8
	S8 PART MARKING
	1457

Consult factory for Industrial and Military grade parts.

ELECTRICAL CHARACTERISTICS $V_S = \pm 15V$, $T_A = 25^{\circ}C$, $V_{CM} = 0V$ unless otherwise noted. (Note 1)

SYMBOL	PARAMETER	CONDITIONS	LT1457AC			LT1457C/LT1457S8			UNITS
			MIN	TYP	MAX	MIN	TYP	MAX	
V_{OS}	Input Offset Voltage	LT1457AC/C LT1457S8		150	450		200	800	μV
I_{OS}	Input Offset Current	Fully Warmed Up		3	40		4	50	μA
I_B	Input Bias Current	Fully Warmed Up		± 5	± 50		± 7	± 75	μA
	Input Resistance-Differential			10^{12}			10^{12}		Ω
	-Common-Mode	$V_{CM} = -11V$ to $8V$ $V_{CM} = 8V$ to $11V$		10^{12}			10^{12}		Ω
				10^{11}			10^{11}		Ω
	Input Capacitance			4			4		μF
e_n	Input Noise Voltage	0.1Hz to 10Hz		2.0			2.1		μV_{P-P}
e_n	Input Noise Voltage Density	$f_0 = 10Hz$ $f_0 = 1kHz$ (Note 2)		26	22		28	24	nV/\sqrt{Hz} nV/\sqrt{Hz}
i_n	Input Noise Current Density	$f_0 = 10Hz, 1kHz$ (Note 3)		1.5	4		1.8	6	fA/\sqrt{Hz}
A_{VOL}	Large-Signal Voltage Gain	$V_O = \pm 10V$, $R_L = 2k$ $V_O = \pm 10V$, $R_L = 1k$	150	350		100	300		V/mV
			120	250		80	220		V/mV
	Input Voltage Range		± 10.5	14.3		± 10.5	14.3		V
				-11.5			-11.5		V
CMRR	Common-Mode Rejection Ratio	$V_{CM} = \pm 10.5V$	86	100		82	98		dB
PSRR	Power Supply Rejection Ratio	$V_S = \pm 4.5V$ to $\pm 18V$	88	103		86	102		dB
V_{OUT}	Output Voltage Swing	$R_L = 2k$	± 12	± 13		± 12	± 13		V
SR	Slew Rate		2	4		2	4		$V/\mu s$

ELECTRICAL CHARACTERISTICS $V_S = \pm 15V, T_A = 25^\circ C, V_{CM} = 0V$ unless otherwise noted. (Note 1)

SYMBOL	PARAMETER	CONDITIONS	LT1457AC			LT1457C/LT1457S8			UNITS
			MIN	TYP	MAX	MIN	TYP	MAX	
GBW	Gain-Bandwidth Product	(Note 5)	1.0	1.7		1.0	1.7		MHz
I_S	Supply Current Per Amplifier			1.8	3.0		1.8	3.0	mA
	Channel Separation	DC to 5kHz, $V_{IN} = \pm 10V$		132			130		dB

ELECTRICAL CHARACTERISTICS $V_S = \pm 15V, V_{CM} = 0V, 0^\circ C \leq T_A \leq 70^\circ C$, unless otherwise noted.

SYMBOL	PARAMETER	CONDITIONS		LT1457AC			LT1457C/LT1457S8			UNITS
				MIN	TYP	MAX	MIN	TYP	MAX	
V_{OS}	Input Offset Voltage	LT1457AC/C LT1457S8	● ●	250	900		330	1500	μV μV	
	Average Temperature Coefficient of Input Offset Voltage (Note 4)		●	3	10		4	16	$\mu V/^\circ C$	
	I_{OS}	Input Offset Current	Warmed Up, $T_A = 70^\circ C$		18	150		20	250	pA
I_B	Input Bias Current	Warmed Up, $T_A = 70^\circ C$		± 50	± 250		± 60	± 350	pA	
A_{VOL}	Large-Signal Voltage Gain	$V_O = \pm 10V, R_L = 2k$	●	70	220		50	200	V/mV	
CMRR	Common-Mode Rejection Ratio	$V_{CM} = \pm 10.4V$	●	85	98		80	96	dB	
PSRR	Power Supply Rejection Ratio	$V_S = \pm 4.5V$ to $\pm 18V$	●	87	102		84	100	dB	
V_{OUT}	Output Voltage Swing	$R_L = 2k$	●	± 12	± 12.8		± 12	± 12.8	V	
I_S	Supply Current Per Amplifier	$T_A = 70^\circ C$	●		3.2			3.2	mA mA	
				1.7			1.7			

ELECTRICAL CHARACTERISTICS $V_S = \pm 15V, V_{CM} = 0V, -40^\circ C \leq T_A \leq 85^\circ C$, unless otherwise noted. (Note 6)

SYMBOL	PARAMETER	CONDITIONS		LT1457AC			LT1457C/LT1457S8			UNITS
				MIN	TYP	MAX	MIN	TYP	MAX	
V_{OS}	Input Offset Voltage	LT1457AC/C LT1457S8	● ●	350	1100		400	1800	μV μV	
	Average Temperature Coefficient of Input Offset Voltage		●	3	10		4	16	$\mu V/^\circ C$	
	I_{OS}	Input Offset Current	Warmed Up, $T_A = 85^\circ C$		0.1	0.5		0.1	0.6	nA
I_B	Input Bias Current	Warmed Up, $T_A = 85^\circ C$		± 0.2	± 0.7		± 0.2	± 0.9	nA	
A_{VOL}	Large-Signal Voltage Gain	$V_O = \pm 10V, R_L = 2k$	●	40	120		30	110	V/mV	
CMRR	Common-Mode Rejection Ratio	$V_{CM} = \pm 10.4V$	●	84	97		80	95	dB	
PSRR	Power Supply Rejection Ratio	$V_S = \pm 5V$ to $\pm 17V$	●	86	100		83	98	dB	
V_{OUT}	Output Voltage Swing	$R_L = 2k$	●	± 12	± 12.7		± 12	± 12.6	V	
I_S	Supply Current Per Amplifier	$T_A = -40^\circ C$ $T_A = 85^\circ C$			3.8			3.8	mA mA	
				1.7			1.7			

The ● denotes the specifications which apply over the full operating temperature range.

Note 1: Typical parameters are defined as the 60% yield of distributions of individual amplifiers; i.e., out of 100 LT1457s (200 op amps) typically 120 will be better than the indicated specification.

Note 2: This parameter is tested on a sample basis only.

Note 3: Current noise is calculated from the formula: $i_n = (2qI_b)^{1/2}$, where $q = 1.6 \times 10^{-19}$ coulomb. The noise of source resistors up to 1GΩ swamps the contribution of current noise.

Note 4: This parameter is not 100% tested.

Note 5: Gain-Bandwidth product is not tested. It is guaranteed by design and by inference from the slew rate measurement.

Note 6: The LT1457 is not tested and not quality-assurance-sampled at $-40^\circ C$ and at $85^\circ C$. These specifications are guaranteed by design, correlation, and/or inference from $0^\circ C$, $25^\circ C$, and $70^\circ C$ tests.

TYPICAL PERFORMANCE CHARACTERISTICS

Input Bias and Offset Current vs Temperature

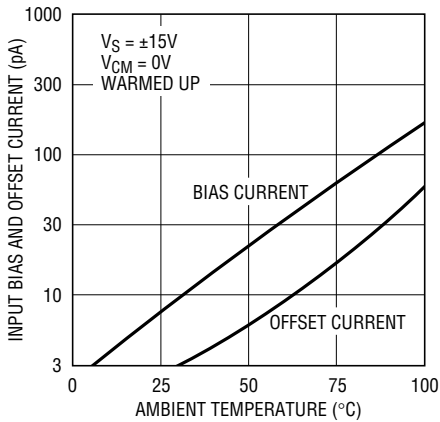

LT1457 • TPC01

Input Bias Current Over the Common-Mode Range

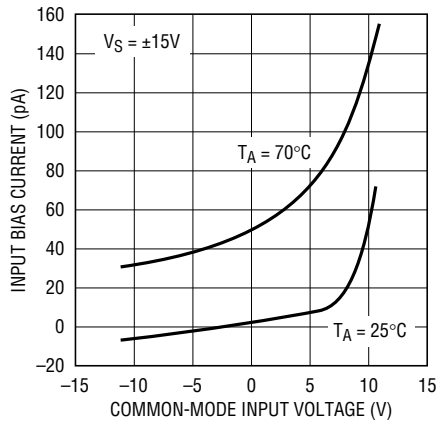

LT1457 • TPC02

Warm-Up Drift

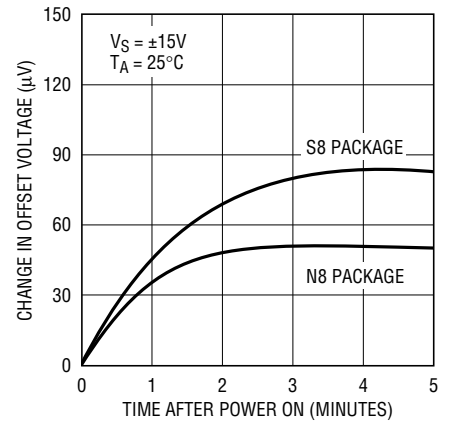

LT1457 • TPC03

Input Offset Voltage Distribution N8 Package

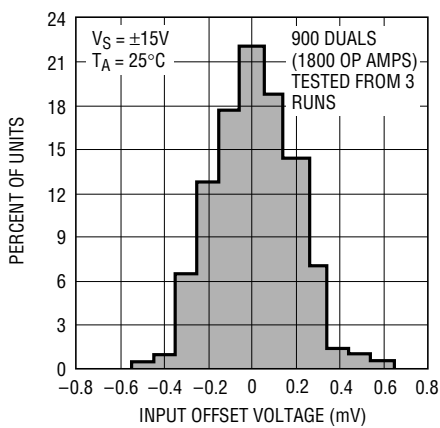

LT1457 • TPC04

Voltage Gain vs Temperature

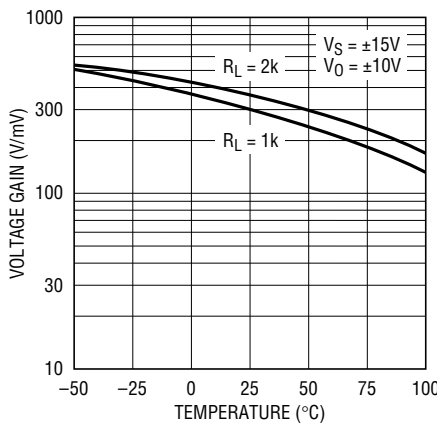

LT1457 • TPC05

Long Term Drift of Representative Units

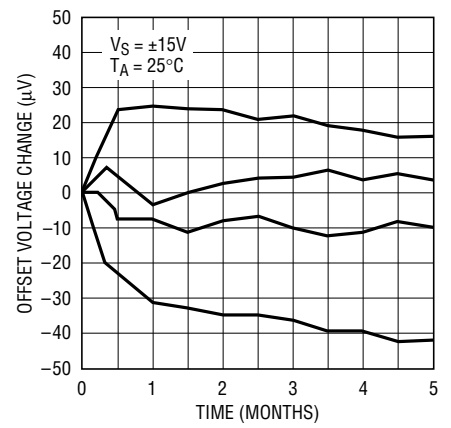

LT1457 • TPC06

Voltage Noise vs Frequency

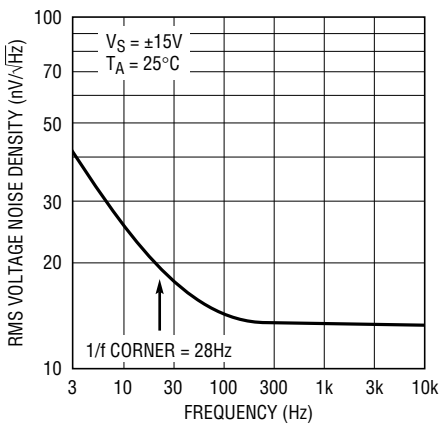

LT1457 • TPC07

0.1Hz to 10Hz Noise

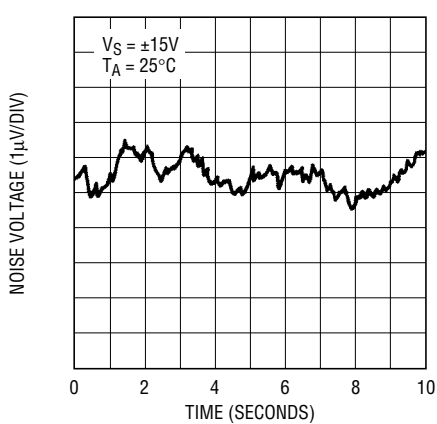

LT1457 • TPC08

Channel Separation vs Frequency

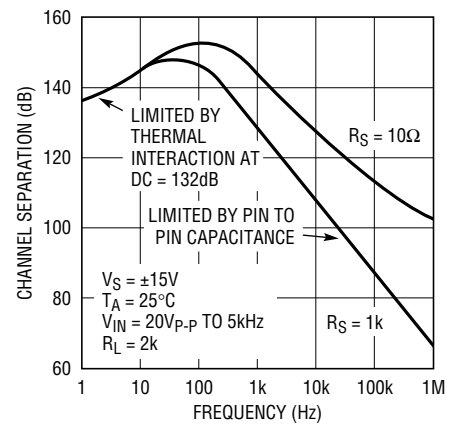

LT1457 • TPC09

TYPICAL PERFORMANCE CHARACTERISTICS

Common-Mode Rejection Ratio vs Frequency

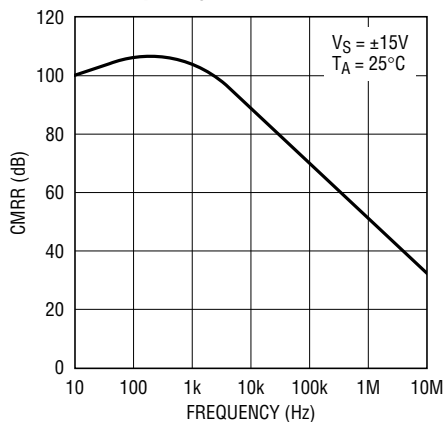

LT1457 • TPC10

Common-Mode Range vs Temperature

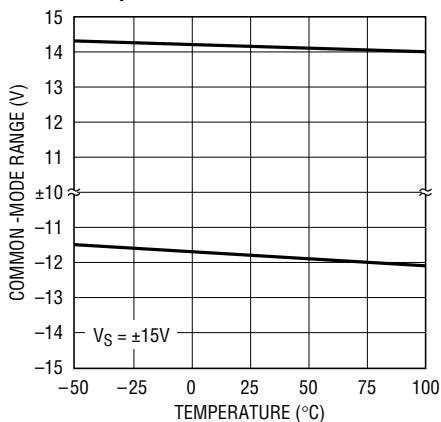

LT1457 • TPC11

Common-Mode and Power Supply Rejections vs Temperature

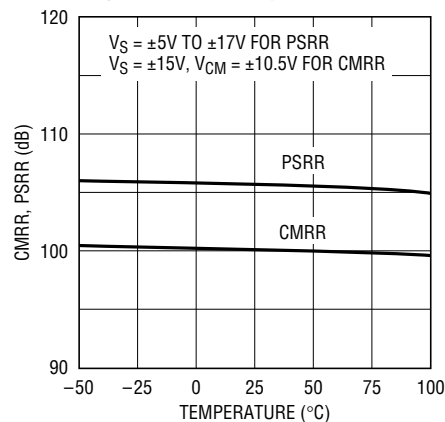

LT1457 • TPC12

Slew Rate, Gain-Bandwidth Product vs Temperature

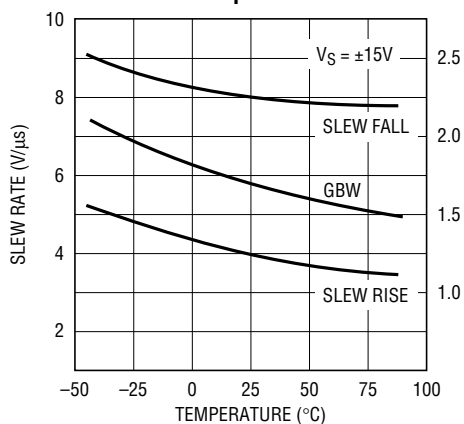

LT1457 • TPC18

Supply Current vs Temperature

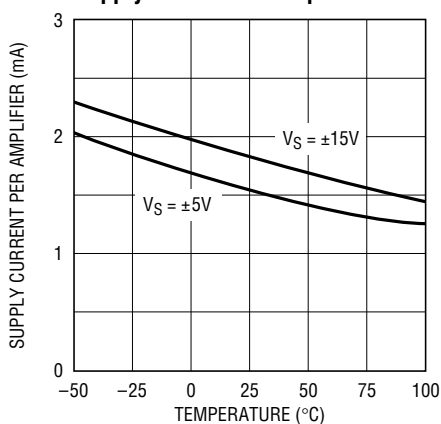

LT1457 • TPC14

Short-Circuit Current vs Time (One Output Shorted to Ground)

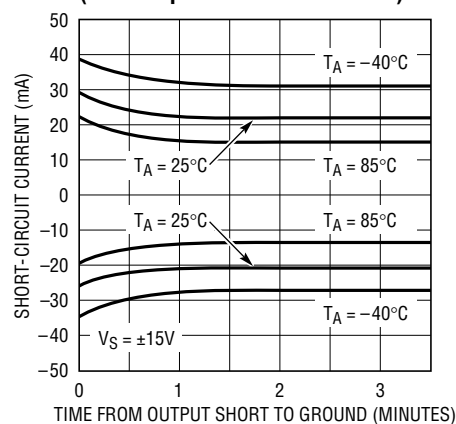

LT1457 • TPC15

Gain, Phase vs Frequency

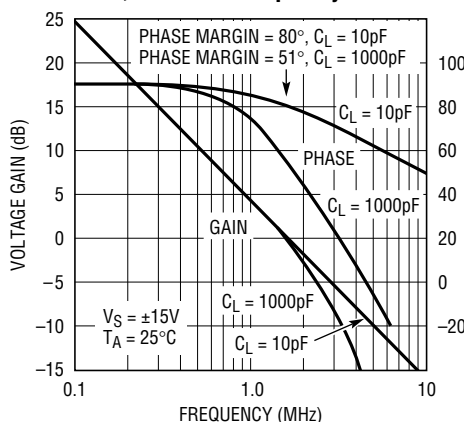

LT1457 • TPC16

Undistorted Output Swing vs Frequency

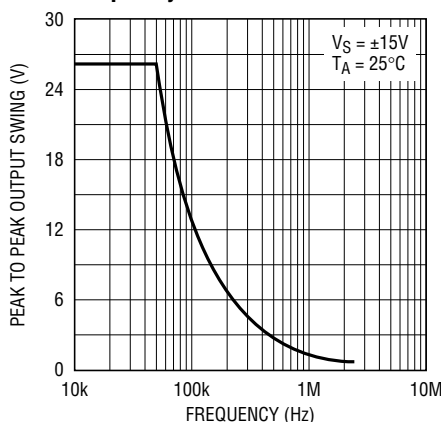

LT1457 • TPC17

Power Supply Rejection Ratio vs Frequency

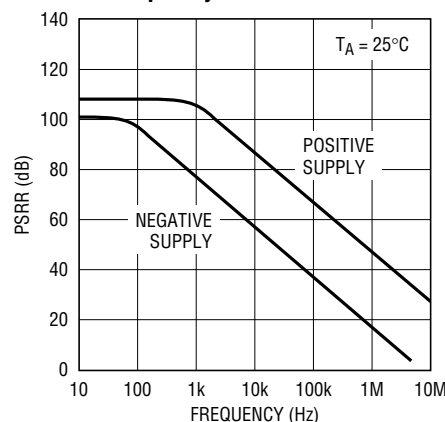

LT1457 • TPC13

TYPICAL PERFORMANCE CHARACTERISTICS

Large-Signal Response
 $A_V = 1, C_L = 100\text{pF}$

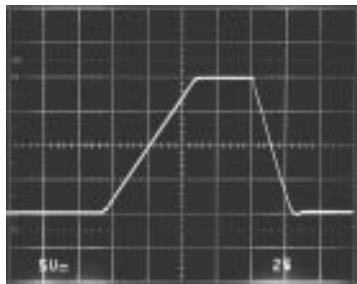

LT1457 TPC19

Small-Signal Response
 $A_V = 1, C_L = 1000\text{pF}$

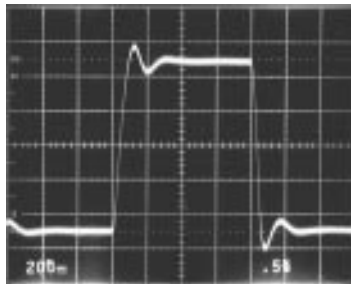

LT1457 TPC20

Small-Signal Response
 $A_V = 1, C_L = 10,000\text{pF}$

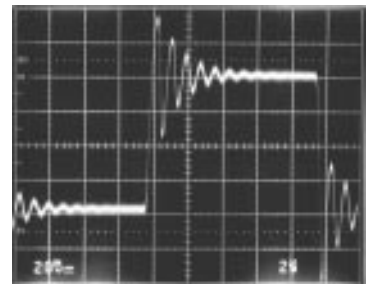

LT1457 TPC21

APPLICATIONS INFORMATION

Phase Reversal Protection

Most industry standard JFET input single, dual, and quad op amps (e.g., LF156, LF351, LF353, LF411, LF412, OP-15, OP-16, OP-215, and TL084) exhibit phase reversal at the output when the negative common-mode limit at the input is exceeded (i.e., below -12V with $\pm 15\text{V}$ supplies). The photos show a $\pm 16\text{V}$ sine wave input (A), the response

of an LF412A in the unity gain follower mode (B), and the response of the LT1457 (C).

The phase reversal of photo (B) can cause lock-up in servo systems. The LT1457 does not phase-reverse due to a unique phase reversal protection circuit.

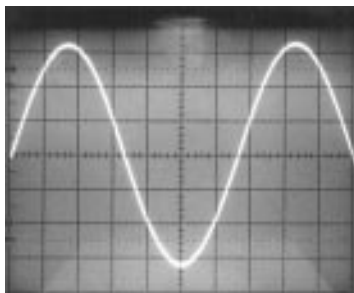

LT1457 A101

(A) $\pm 16\text{V}$ Sine Wave Input

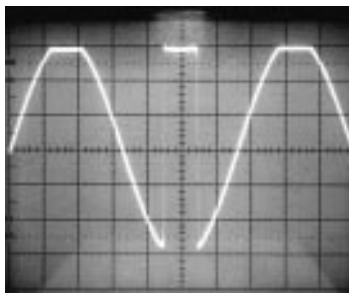

LT1457 A102

(B) LF412A Output

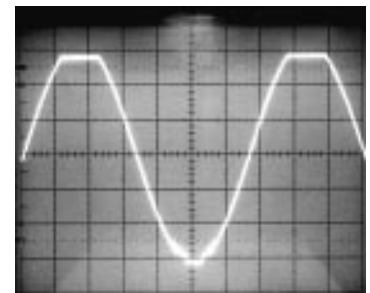

LT1457 A103

(C) LT1457 Output

All Photos 5V/Div Vertical Scale, 50µs/Div Horizontal Scale

APPLICATIONS INFORMATION

High Speed Operation

When the feedback around the op amp is resistive (R_F), a pole will be created with R_F , the source resistance and capacitance (R_S, C_S), and the amplifier input capacitance ($C_{IN} \approx 4\text{pF}$). In low closed loop gain configurations and with R_S and R_F in the kilohm range, this pole can create excess phase shift and even oscillation on high speed amplifiers. Because the LT1457's phase margin is very high, this problem is minimal. However, a small capacitor (C_F) in parallel with R_F eliminates this problem. With $R_S(C_S + C_{IN}) = R_F C_F$, the effect of the feedback pole is completely removed.

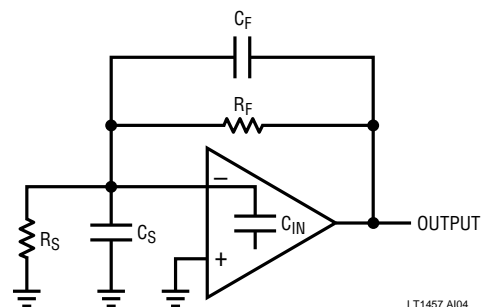

LT1457 A104

PACKAGE DESCRIPTION

Dimension in inches (millimeters) unless otherwise noted.

N8 Package 8-Lead Plastic DIP

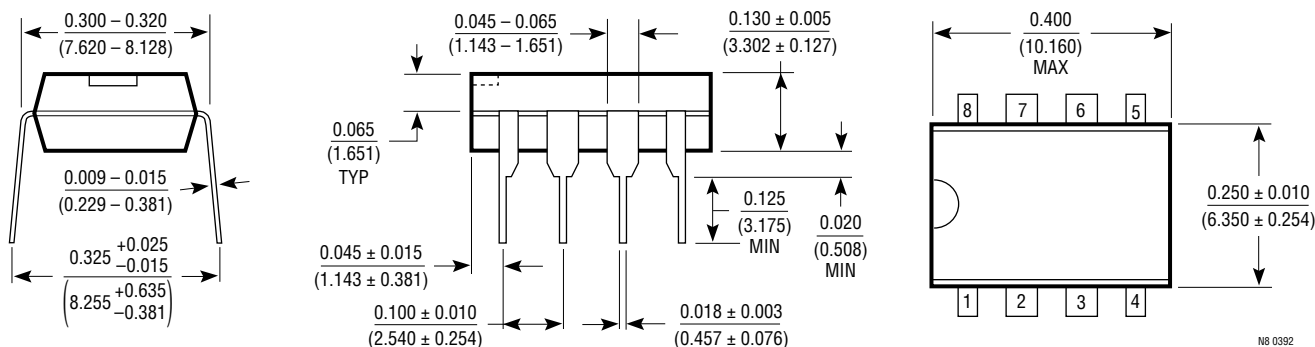

N8 0392

S8 Package 8-Lead Plastic SOIC

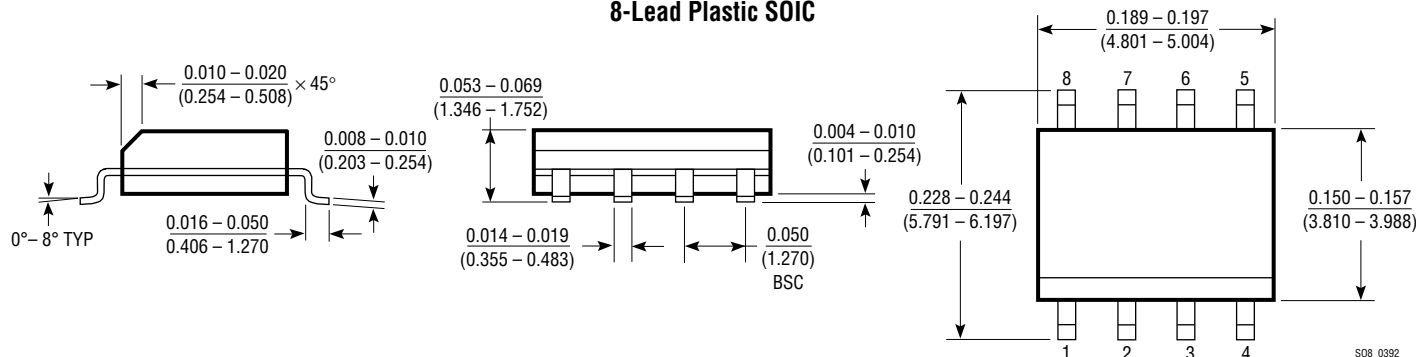

S08 0392

U.S. Area Sales Offices

NORTHEAST REGION

Linear Technology Corporation
 One Oxford Valley
 2300 E. Lincoln Hwy., Suite 306
 Langhorne, PA 19047
 Phone: (215) 757-8578
 FAX: (215) 757-5631

Linear Technology Corporation

266 Lowell St., Suite B-8
 Wilmington, MA 01887
 Phone: (508) 658-3881
 FAX: (508) 658-2701

SOUTHEAST REGION

Linear Technology Corporation
 17060 Dallas Parkway
 Suite 208
 Dallas, TX 75248
 Phone: (214) 733-3071
 FAX: (214) 380-5138

CENTRAL REGION

Linear Technology Corporation
 Chesapeake Square
 229 Mitchell Court, Suite A-25
 Addison, IL 60101
 Phone: (708) 620-6910
 FAX: (708) 620-6977

SOUTHWEST REGION

Linear Technology Corporation
 22141 Ventura Blvd.
 Suite 206
 Woodland Hills, CA 91364
 Phone: (818) 703-0835
 FAX: (818) 703-0517

NORTHWEST REGION

Linear Technology Corporation
 782 Sycamore Dr.
 Milpitas, CA 95035
 Phone: (408) 428-2050
 FAX: (408) 432-6331

International Sales Offices

FRANCE

Linear Technology S.A.R.L.
 Immeuble "Le Quartz"
 58 Chemin de la Justice
 92290 Chatenay Malabry
 France
 Phone: 33-1-41079555
 FAX: 33-1-46314613

GERMANY

Linear Technolgy GmbH
 Untere Hauptstr. 9
 D-85386 Eching
 Germany
 Phone: 49-89-3197410
 FAX: 49-89-3194821

JAPAN

Linear Technology KK
 5F YZ Bldg.
 4-4-12 Iidabashi, Chiyoda-Ku
 Tokyo, 102 Japan
 Phone: 81-3-3237-7891
 FAX: 81-3-3237-8010

KOREA

Linear Technology Korea Branch
 Namsong Building, #505
 Itaewon-Dong 260-199
 Yongsan-Ku, Seoul
 Korea
 Phone: 82-2-792-1617
 FAX: 82-2-792-1619

SINGAPORE

Linear Technology Pte. Ltd.
 101 Boon Keng Road
 #02-15 Kallang Ind. Estates
 Singapore 1233
 Phone: 65-293-5322
 FAX: 65-292-0398

TAIWAN

Linear Technology Corporation
 Rm. 801, No. 46, Sec. 2
 Chung Shan N. Rd.
 Taipei, Taiwan, R.O.C.
 Phone: 886-2-521-7575
 FAX: 886-2-562-2285

UNITED KINGDOM

Linear Technology (UK) Ltd.
 The Coliseum, Riverside Way
 Camberley, Surrey GU15 3YL
 United Kingdom
 Phone: 44-276-677676
 FAX: 44-276-64851

World Headquarters

Linear Technology Corporation
 1630 McCarthy Blvd.
 Milpitas, CA 95035-7487
 Phone: (408) 432-1900
 FAX: (408) 434-0507