



APT6035AVR

600V 16A 0.350Ω

POWER MOS V[®]

Power MOS V[®] is a new generation of high voltage N-Channel enhancement mode power MOSFETs. This new technology minimizes the JFET effect, increases packing density and reduces the on-resistance. Power MOS V[®] also achieves faster switching speeds through optimized gate layout.

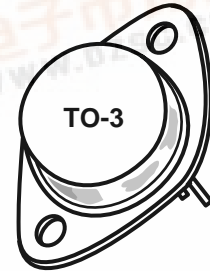

- Faster Switching
- Lower Leakage
- 100% Avalanche Tested
- Popular TO-3 Package



MAXIMUM RATINGS

All Ratings: T_C = 25°C unless otherwise specified.

Symbol	Parameter	APT6035AVR	UNIT
V _{DSS}	Drain-Source Voltage	600	Volts
I _D	Continuous Drain Current @ T _C = 25°C	16	Amps
I _{DM}	Pulsed Drain Current ^①	64	
V _{GS}	Gate-Source Voltage Continuous	±30	Volts
V _{GSM}	Gate-Source Voltage Transient	±40	
P _D	Total Power Dissipation @ T _C = 25°C	200	Watts
	Linear Derating Factor	1.6	W/°C
T _J , T _{STG}	Operating and Storage Junction Temperature Range	-55 to 150	°C
T _L	Lead Temperature: 0.063" from Case for 10 Sec.	300	
I _{AR}	Avalanche Current ^① (Repetitive and Non-Repetitive)	16	Amps
E _{AR}	Repetitive Avalanche Energy ^①	30	mJ
E _{AS}	Single Pulse Avalanche Energy ^④	1210	

STATIC ELECTRICAL CHARACTERISTICS

Symbol	Characteristic / Test Conditions	MIN	TYP	MAX	UNIT
BV _{DSS}	Drain-Source Breakdown Voltage (V _{GS} = 0V, I _D = 250μA)	600			Volts
I _{D(on)}	On State Drain Current ^② (V _{DS} > I _{D(on)} × R _{DS(on)} Max, V _{GS} = 10V)	16			Amps
R _{DS(on)}	Drain-Source On-State Resistance ^② (V _{GS} = 10V, 0.5 I _{D(Cont.)})			0.350	Ohms
I _{DSS}	Zero Gate Voltage Drain Current (V _{DS} = V _{DSS} , V _{GS} = 0V)			25	μA
	Zero Gate Voltage Drain Current (V _{DS} = 0.8 V _{DSS} , V _{GS} = 0V, T _C = 125°C)			250	
I _{GSS}	Gate-Source Leakage Current (V _{GS} = ±30V, V _{DS} = 0V)			±100	nA
V _{GS(th)}	Gate Threshold Voltage (V _{DS} = V _{GS} , I _D = 1.0mA)	2		4	Volts

CAUTION: These Devices are Sensitive to Electrostatic Discharge. Proper Handling Procedures Should Be Followed.

APT Website - <http://www.advancedpower.com>

Bend, Oregon 97702-1035 Phone: (541) 382-8028 FAX: (541) 388-0364



DYNAMIC CHARACTERISTICS

APT6035AVR

Symbol	Characteristic	Test Conditions	MIN	TYP	MAX	UNIT
C_{iss}	Input Capacitance	$V_{GS} = 0V$ $V_{DS} = 25V$ $f = 1 \text{ MHz}$		3450	4140	pF
C_{oss}	Output Capacitance			403	565	
C_{rss}	Reverse Transfer Capacitance			155	235	
Q_g	Total Gate Charge ^③	$V_{GS} = 10V$ $V_{DD} = 0.5 V_{DSS}$ $I_D = I_{D[Cont.]} @ 25^\circ C$		140	210	nC
Q_{gs}	Gate-Source Charge			19	30	
Q_{gd}	Gate-Drain ("Miller") Charge			68	100	
$t_{d(on)}$	Turn-on Delay Time	$V_{GS} = 15V$ $V_{DD} = 0.5 V_{DSS}$ $I_D = I_{D[Cont.]} @ 25^\circ C$ $R_G = 1.6\Omega$		12	24	ns
t_r	Rise Time			12	24	
$t_{d(off)}$	Turn-off Delay Time			40	60	
t_f	Fall Time			8	16	

SOURCE-DRAIN DIODE RATINGS AND CHARACTERISTICS

Symbol	Characteristic / Test Conditions	MIN	TYP	MAX	UNIT
I_S	Continuous Source Current (Body Diode)			16	Amps
I_{SM}	Pulsed Source Current ^① (Body Diode)			64	
V_{SD}	Diode Forward Voltage ^② ($V_{GS} = 0V, I_S = -I_{D[Cont.]}$)			1.3	Volts
t_{rr}	Reverse Recovery Time ($I_S = -I_{D[Cont.]}, di_S/dt = 100A/\mu s$)		450		ns
Q_{rr}	Reverse Recovery Charge ($I_S = -I_{D[Cont.]}, di_S/dt = 100A/\mu s$)		8		μC

THERMAL CHARACTERISTICS

Symbol	Characteristic	MIN	TYP	MAX	UNIT
$R_{\theta JC}$	Junction to Case			0.62	$^\circ C/W$
$R_{\theta JA}$	Junction to Ambient			30	

① Repetitive Rating: Pulse width limited by maximum junction temperature.

③ See MIL-STD-750 Method 3471

② Pulse Test: Pulse width < 380 μs , Duty Cycle < 2%

④ Starting $T_j = +25^\circ C$, $L = 9.45mH$, $R_G = 25\Omega$, Peak $I_L = 16A$

APT Reserves the right to change, without notice, the specifications and information contained herein.

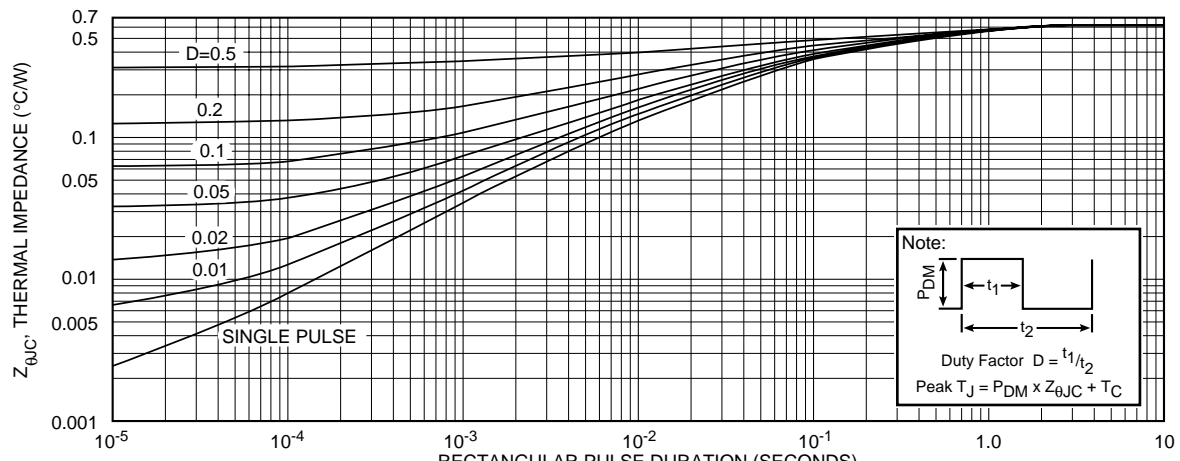

APT6035AVR

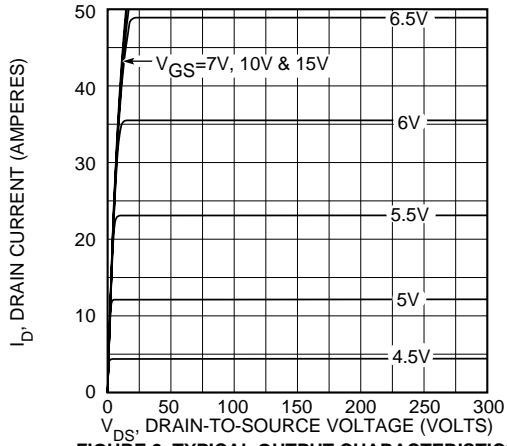

FIGURE 2, TYPICAL OUTPUT CHARACTERISTICS

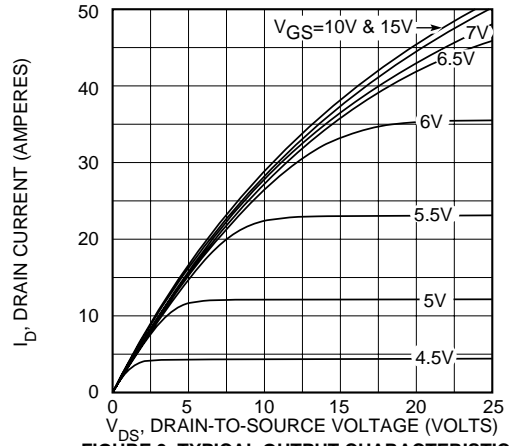

FIGURE 3, TYPICAL OUTPUT CHARACTERISTICS

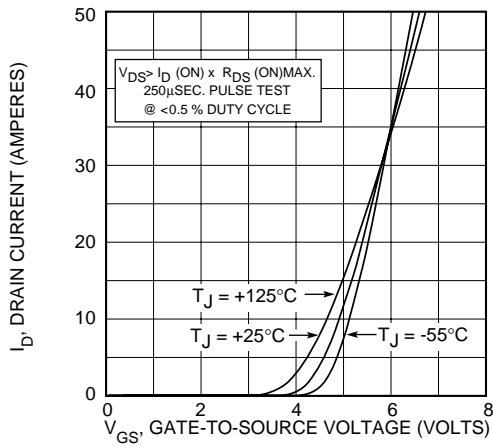

FIGURE 4, TYPICAL TRANSFER CHARACTERISTICS

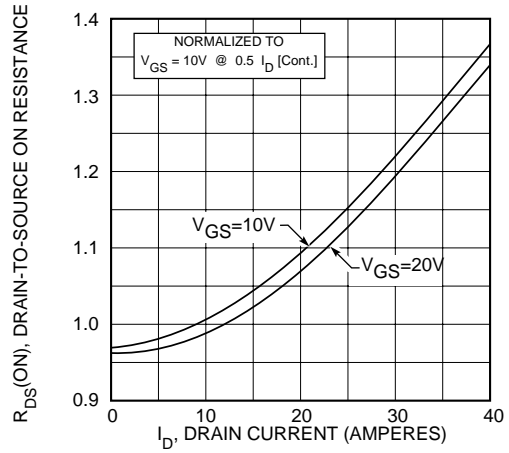

FIGURE 5, $R_{DS(ON)}$ vs DRAIN CURRENT

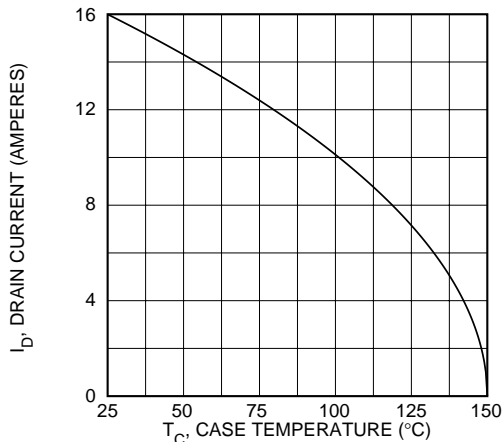

FIGURE 6, MAXIMUM DRAIN CURRENT vs CASE TEMPERATURE

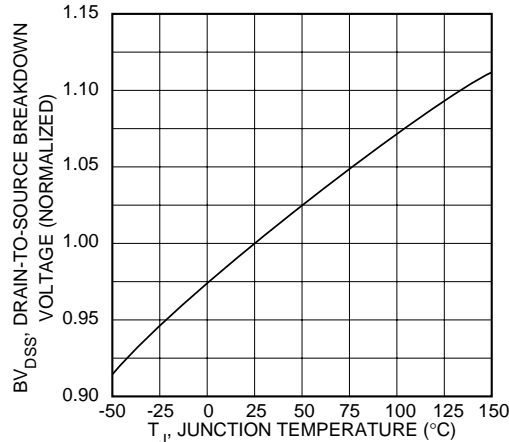

FIGURE 7, BREAKDOWN VOLTAGE vs TEMPERATURE

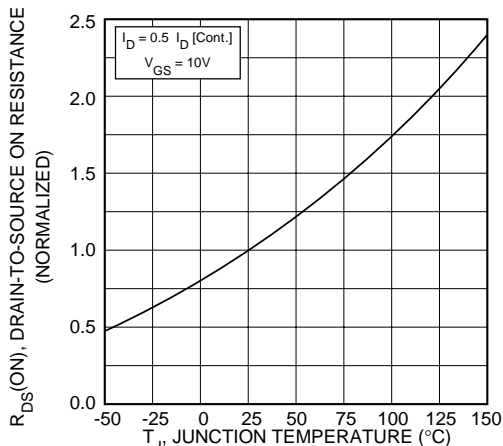

FIGURE 8, ON-RESISTANCE vs. TEMPERATURE

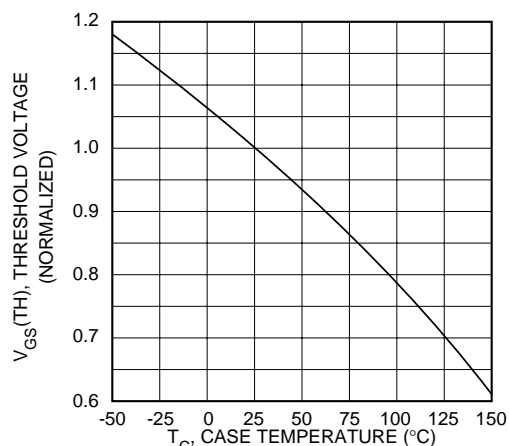

FIGURE 9, THRESHOLD VOLTAGE vs TEMPERATURE

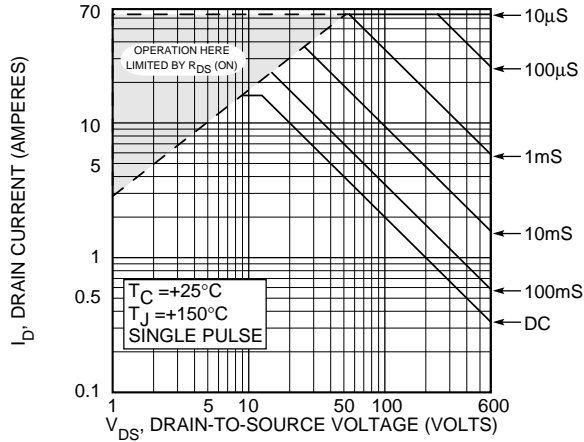

FIGURE 10, MAXIMUM SAFE OPERATING AREA

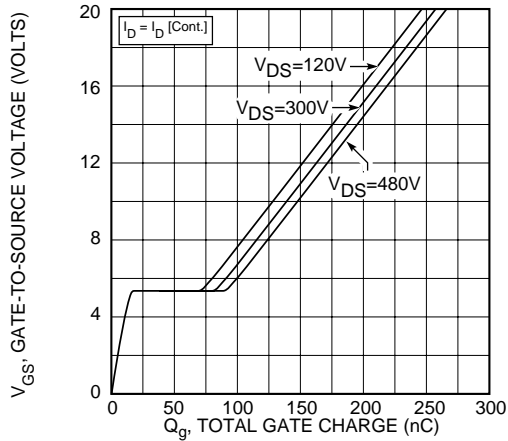

FIGURE 12, GATE CHARGES vs GATE-TO-SOURCE VOLTAGE

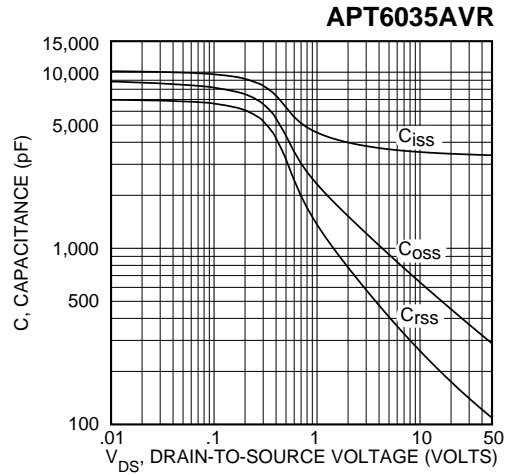

FIGURE 11, TYPICAL CAPACITANCE vs DRAIN-TO-SOURCE VOLTAGE

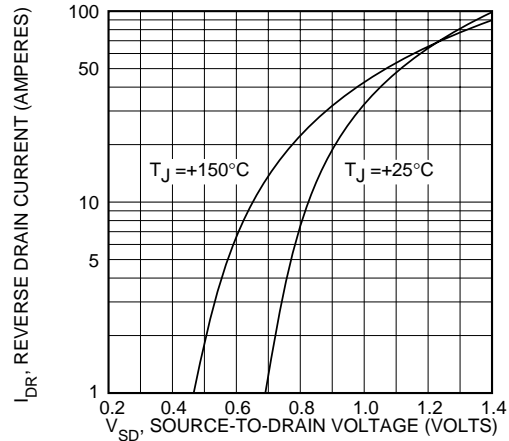
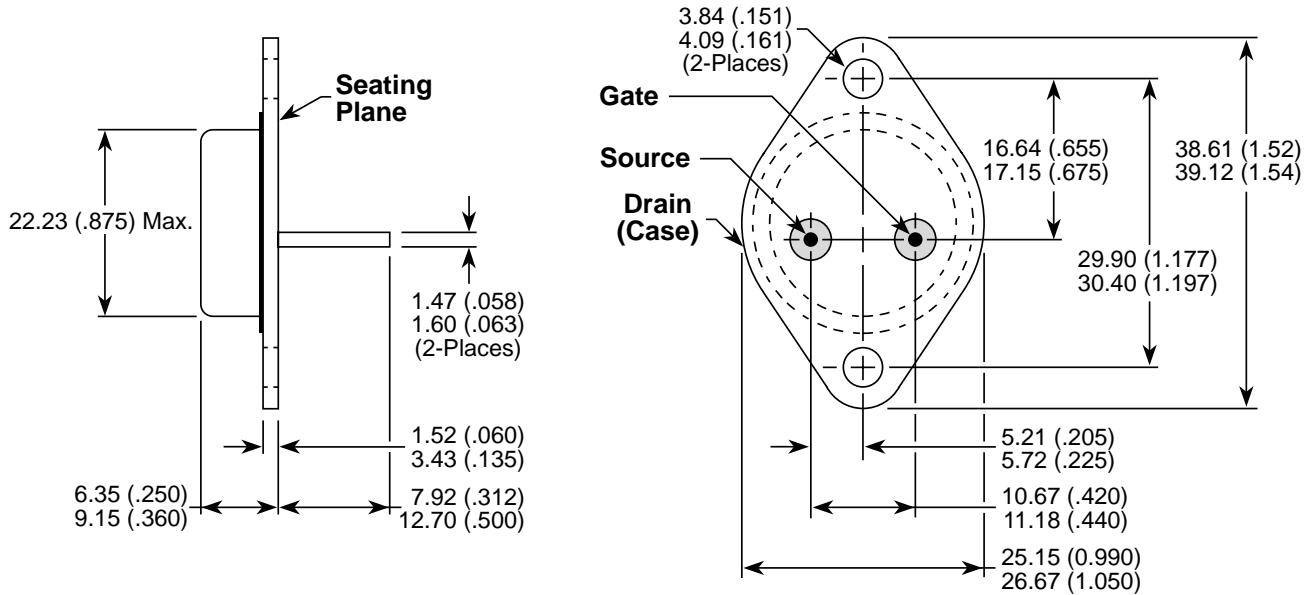

FIGURE 13, TYPICAL SOURCE-DRAIN DIODE FORWARD VOLTAGE

TO-3 (TO-204AE) Package Outline



Dimensions in Millimeters and (Inches)