

# International IOR Rectifier

SMPS MOSFET

# IRFP15N60L

PD - 94415

HEXFET® Power MOSFET

### Applications

- Zero Voltage Switching SMPS
- Telecom and Server Power Supplies
- Uninterruptible Power Supplies
- Motor Control applications

V <sub>DSS</sub>	R <sub>DS(on)</sub> typ.	T <sub>rr</sub> typ.	I <sub>D</sub>
600V	385mΩ	130ns	15A

### Features and Benefits

- SuperFast body diode eliminates the need for external diodes in ZVS applications.
- Lower Gate charge results in simpler drive requirements.
- Enhanced dv/dt capabilities offer improved ruggedness.
- Higher Gate voltage threshold offers improved noise immunity.



### Absolute Maximum Ratings

	Parameter	Max.	Units
I <sub>D</sub> @ T <sub>C</sub> = 25°C	Continuous Drain Current, V <sub>GS</sub> @ 10V	15	A
I <sub>D</sub> @ T <sub>C</sub> = 100°C	Continuous Drain Current, V <sub>GS</sub> @ 10V	9.7	
I <sub>DM</sub>	Pulsed Drain Current ①	60	
P <sub>D</sub> @ T <sub>C</sub> = 25°C	Power Dissipation	280	W
	Linear Derating Factor	2.3	W/°C
V <sub>GS</sub>	Gate-to-Source Voltage	±30	V
dv/dt	Peak Diode Recovery dv/dt ②	10	V/ns
T <sub>J</sub> T <sub>STG</sub>	Operating Junction and Storage Temperature Range	-55 to + 150	°C
	Soldering Temperature, for 10 seconds	300 (1.6mm from case )	
	Mounting torque, 6-32 or M3 screw	1.1(10)	

### Diode Characteristics

Symbol	Parameter	Min.	Typ.	Max.	Units	Conditions
I <sub>S</sub>	Continuous Source Current (Body Diode)	—	—	15	A	MOSFET symbol showing the integral reverse p-n junction diode.
I <sub>SM</sub>	Pulsed Source Current (Body Diode) ①	—	—	60		
V <sub>SD</sub>	Diode Forward Voltage	—	—	1.5	V	T <sub>J</sub> = 25°C, I <sub>S</sub> = 15A, V <sub>GS</sub> = 0V ④
t <sub>rr</sub>	Reverse Recovery Time	—	130	200	ns	T <sub>J</sub> = 25°C, I <sub>F</sub> = 15A
		—	240	360		T <sub>J</sub> = 125°C, di/dt = 100A/μs ④
Q <sub>rr</sub>	Reverse Recovery Charge	—	450	670	nC	T <sub>J</sub> = 25°C, I <sub>S</sub> = 15A, V <sub>GS</sub> = 0V ④
		—	1080	1620		T <sub>J</sub> = 125°C, di/dt = 100A/μs ④
I <sub>RRM</sub>	Reverse Recovery Current	—	5.8	8.7	A	T <sub>J</sub> = 25°C
t <sub>on</sub>	Forward Turn-On Time	Intrinsic turn-on time is negligible (turn-on is dominated by LS+LD)				



# IRFP15N60L

International  
IR Rectifier

## Static @ $T_J = 25^\circ\text{C}$ (unless otherwise specified)

Symbol	Parameter	Min.	Typ.	Max.	Units	Conditions
$V_{(BR)DSS}$	Drain-to-Source Breakdown Voltage	600	—	—	V	$V_{GS} = 0V, I_D = 250\mu A$
$\Delta V_{(BR)DSS}/\Delta T_J$	Breakdown Voltage Temp. Coefficient	—	0.39	—	V/°C	Reference to $25^\circ\text{C}$ , $I_D = 1\text{mA}$
$R_{DS(on)}$	Static Drain-to-Source On-Resistance	—	385	460	m $\Omega$	$V_{GS} = 10V, I_D = 9.0A$ ④
$V_{GS(th)}$	Gate Threshold Voltage	3.0	—	5.0	V	$V_{DS} = V_{GS}, I_D = 250\mu A$
$I_{DSS}$	Drain-to-Source Leakage Current	—	—	50	$\mu A$	$V_{DS} = 600V, V_{GS} = 0V$
		—	—	2.0	mA	$V_{DS} = 480V, V_{GS} = 0V, T_J = 125^\circ\text{C}$
$I_{GSS}$	Gate-to-Source Forward Leakage	—	—	100	nA	$V_{GS} = 30V$
	Gate-to-Source Reverse Leakage	—	—	-100	nA	$V_{GS} = -30V$
$R_G$	Internal Gate Resistance	—	0.79	—	$\Omega$	$f = 1\text{MHz}$ , open drain

## Dynamic @ $T_J = 25^\circ\text{C}$ (unless otherwise specified)

Symbol	Parameter	Min.	Typ.	Max.	Units	Conditions
$g_{fs}$	Forward Transconductance	8.3	—	—	S	$V_{DS} = 50V, I_D = 9.0A$
$Q_g$	Total Gate Charge	—	—	100	nC	$I_D = 15A$ $V_{DS} = 480V$ $V_{GS} = 10V$ , See Fig. 7 & 15 ④
$Q_{gs}$	Gate-to-Source Charge	—	—	30		
$Q_{gd}$	Gate-to-Drain ("Miller") Charge	—	—	46		
$t_{d(on)}$	Turn-On Delay Time	—	20	—	ns	$V_{DD} = 300V$ $I_D = 15A$ $R_G = 1.8\Omega$ $V_{GS} = 10V$ , See Fig. 11a & 11b ④
$t_r$	Rise Time	—	44	—		
$t_{d(off)}$	Turn-Off Delay Time	—	28	—		
$t_f$	Fall Time	—	5.5	—		
$C_{iss}$	Input Capacitance	—	2720	—	pF	$V_{GS} = 0V$ $V_{DS} = 25V$ $f = 1.0\text{MHz}$ , See Fig. 5 $V_{GS} = 0V, V_{DS} = 0V$ to $480V$ ⑤
$C_{oss}$	Output Capacitance	—	260	—		
$C_{rss}$	Reverse Transfer Capacitance	—	20	—		
$C_{oss\ eff.}$	Effective Output Capacitance	—	120	—		
$C_{oss\ eff. (ER)}$	Effective Output Capacitance (Energy Related)	—	100	—		

## Avalanche Characteristics

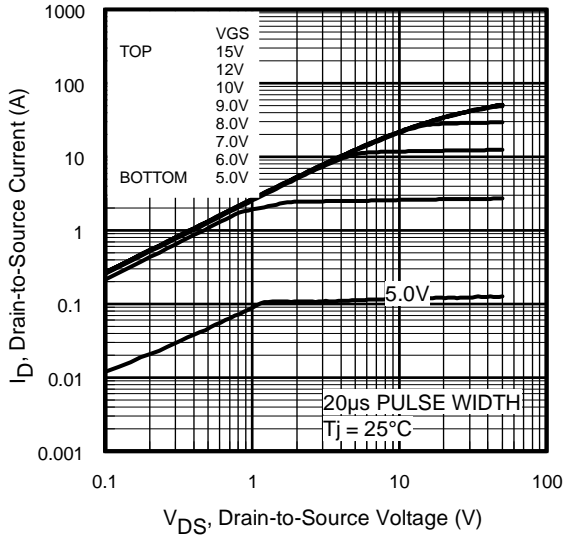
Symbol	Parameter	Typ.	Max.	Units
$E_{AS}$	Single Pulse Avalanche Energy ②	—	320	mJ
$I_{AR}$	Avalanche Current ①	—	15	A
$E_{AR}$	Repetitive Avalanche Energy ①	—	28	mJ

## Thermal Resistance

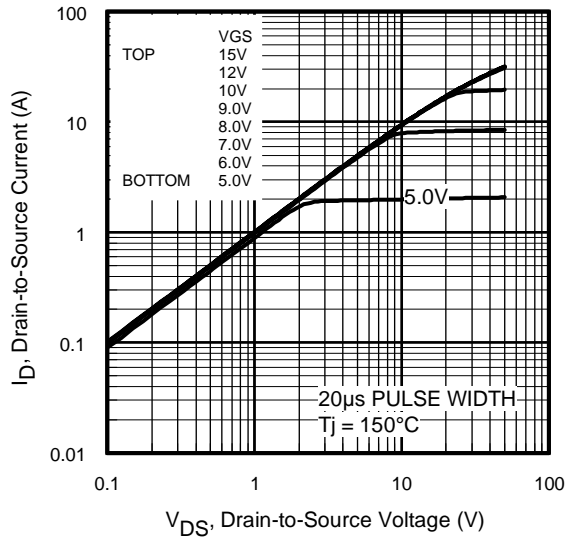
Symbol	Parameter	Typ.	Max.	Units
$R_{\theta JC}$	Junction-to-Case	—	0.44	°C/W
$R_{\theta CS}$	Case-to-Sink, Flat, Greased Surface	0.24	—	
$R_{\theta JA}$	Junction-to-Ambient	—	40	

### Notes:

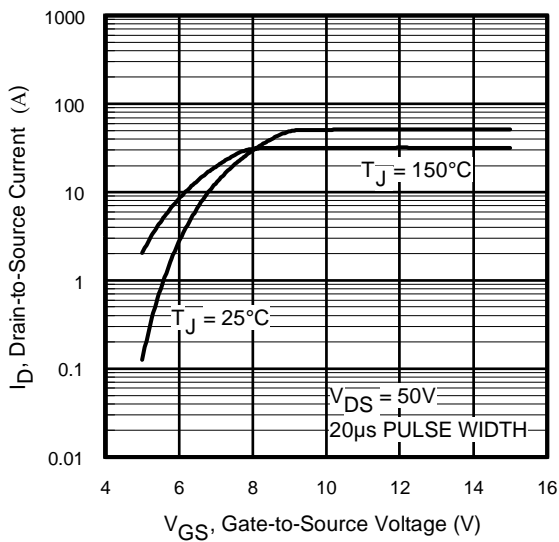
- ① Repetitive rating; pulse width limited by max. junction temperature. (See Fig. 11)
- ② Starting  $T_J = 25^\circ\text{C}$ ,  $L = 2.9\text{mH}$ ,  $R_G = 25\Omega$ ,  $I_{AS} = 15A$ ,  $dv/dt = 10V/ns$ . (See Figure 12a)
- ③  $I_{SD} \leq 15A$ ,  $di/dt \leq 340A/\mu s$ ,  $V_{DD} \leq V_{(BR)DSS}$ ,  $T_J \leq 150^\circ\text{C}$ .
- ④ Pulse width  $\leq 300\mu s$ ; duty cycle  $\leq 2\%$ .
- ⑤  $C_{oss\ eff.}$  is a fixed capacitance that gives the same charging time as  $C_{oss}$  while  $V_{DS}$  is rising from 0 to  $80\% V_{DSS}$ .  
 $C_{oss\ eff. (ER)}$  is a fixed capacitance that stores the same energy as  $C_{oss}$  while  $V_{DS}$  is rising from 0 to  $80\% V_{DSS}$ .



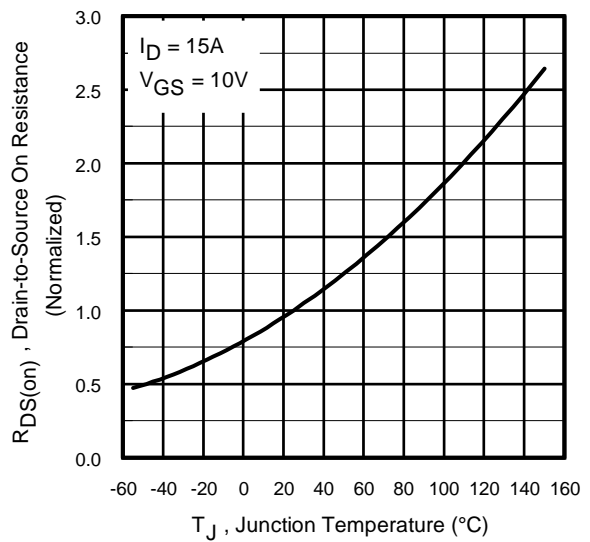
**Fig 1.** Typical Output Characteristics



**Fig 2.** Typical Output Characteristics

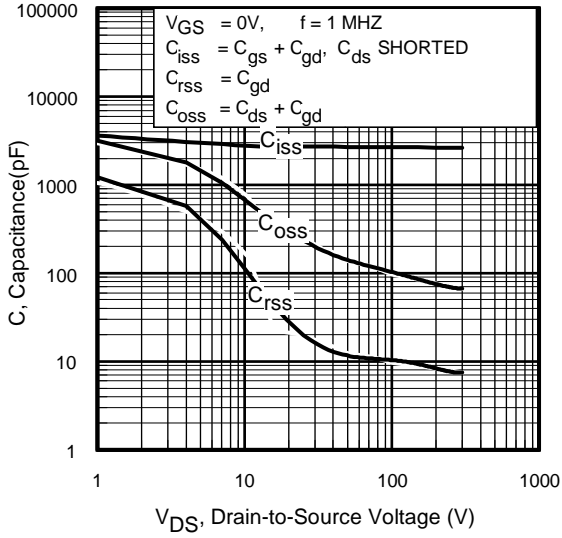


**Fig 3.** Typical Transfer Characteristics

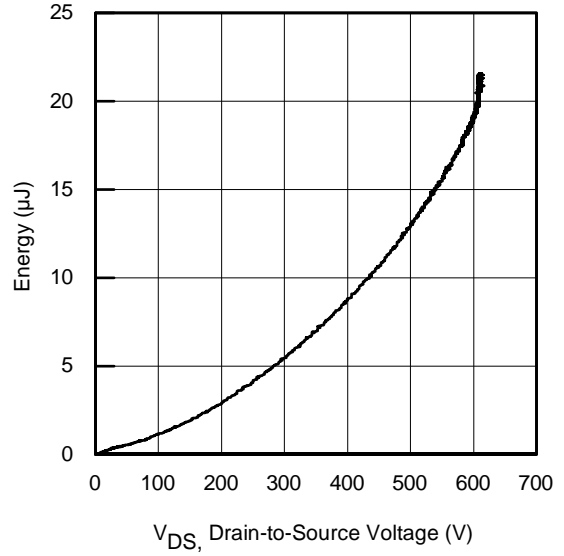


**Fig 4.** Normalized On-Resistance vs. Temperature

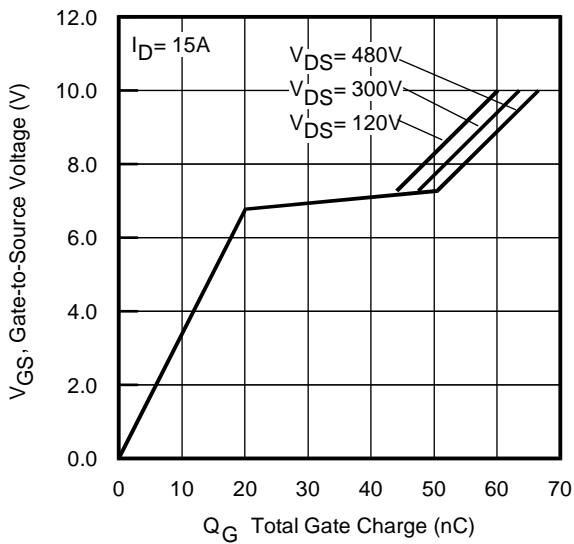
# IRFP15N60L



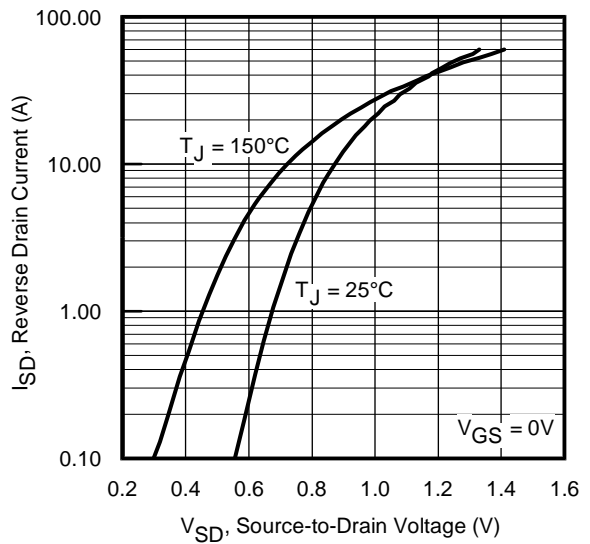
**Fig 5.** Typical Capacitance vs. Drain-to-Source Voltage



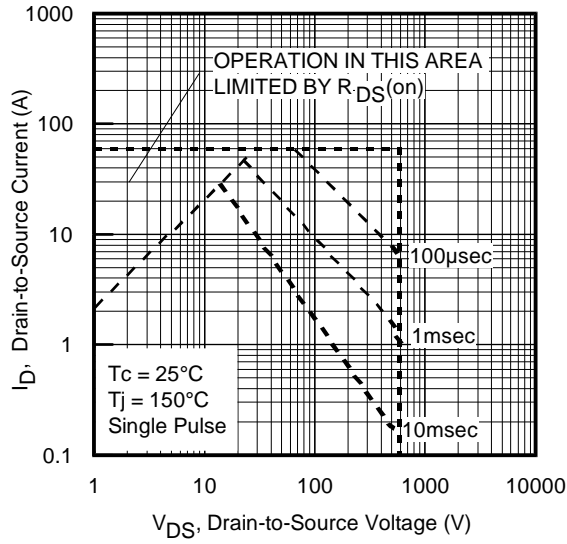
**Fig 6.** Typ. Output Capacitance Stored Energy vs.  $V_{DS}$



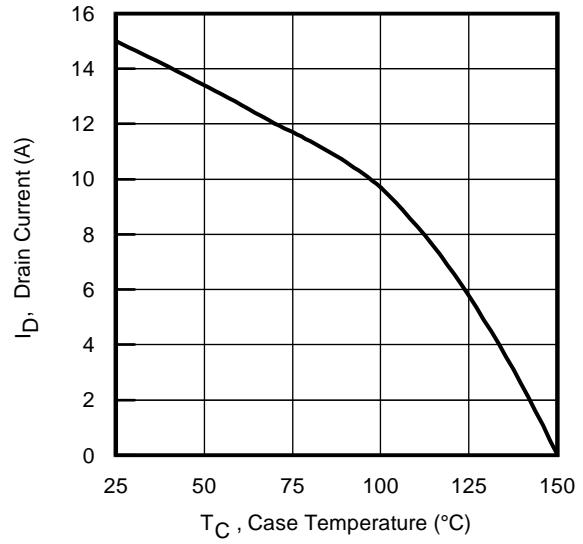
**Fig 7.** Typical Gate Charge vs. Gate-to-Source Voltage



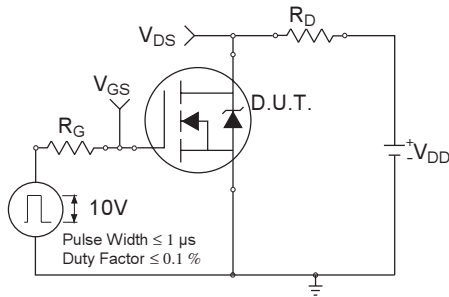
**Fig 8.** Typical Source-Drain Diode Forward Voltage



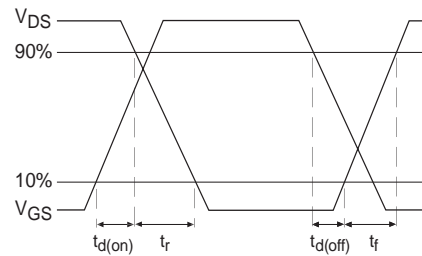
**Fig 9.** Maximum Safe Operating Area



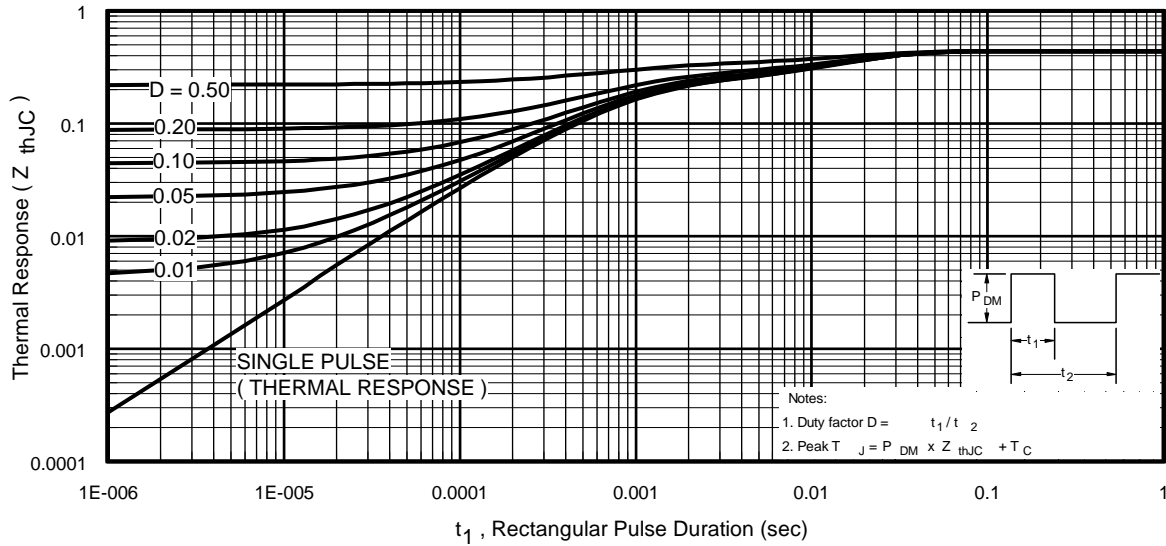
**Fig 10.** Maximum Drain Current vs. Case Temperature



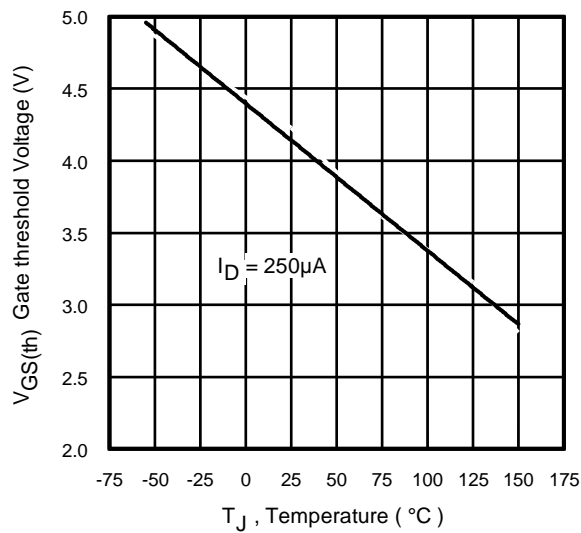
**Fig 11a.** Switching Time Test Circuit



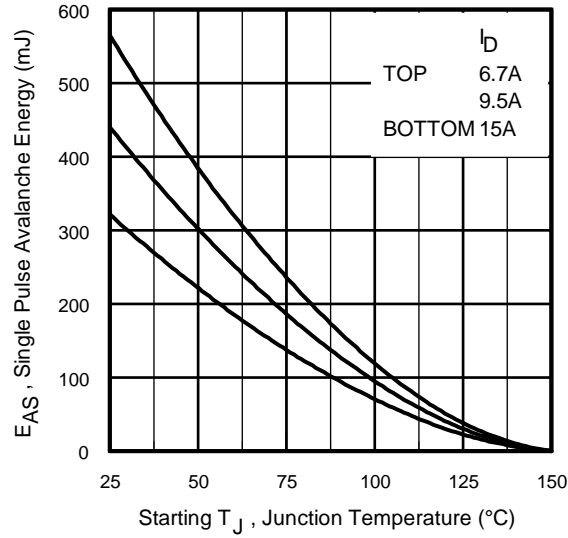
**Fig 11b.** Switching Time Waveforms



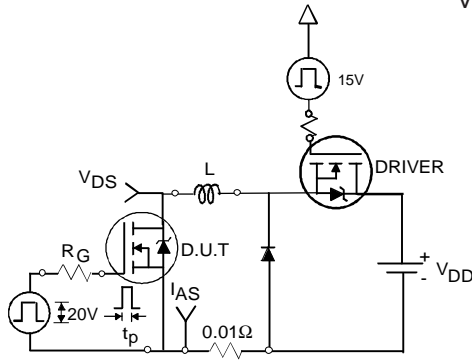
**Fig 12.** Maximum Effective Transient Thermal Impedance, Junction-to-Case



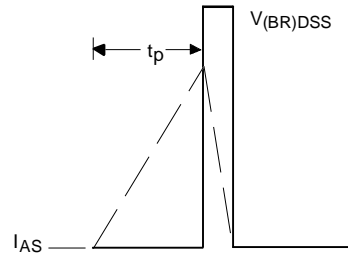
**Fig 13.** Threshold Voltage vs. Temperature



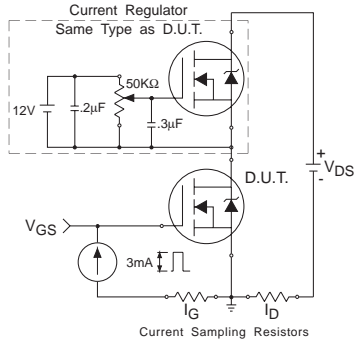
**Fig 14a.** Maximum Avalanche Energy vs. Drain Current



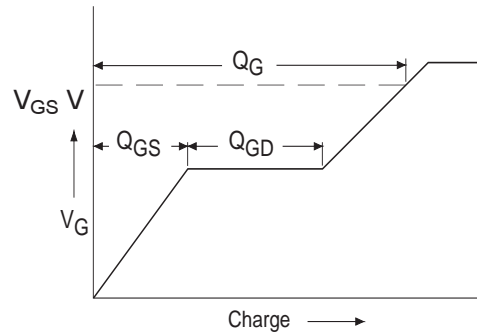
**Fig 14b.** Unclamped Inductive Test Circuit



**Fig 14c.** Unclamped Inductive Waveforms

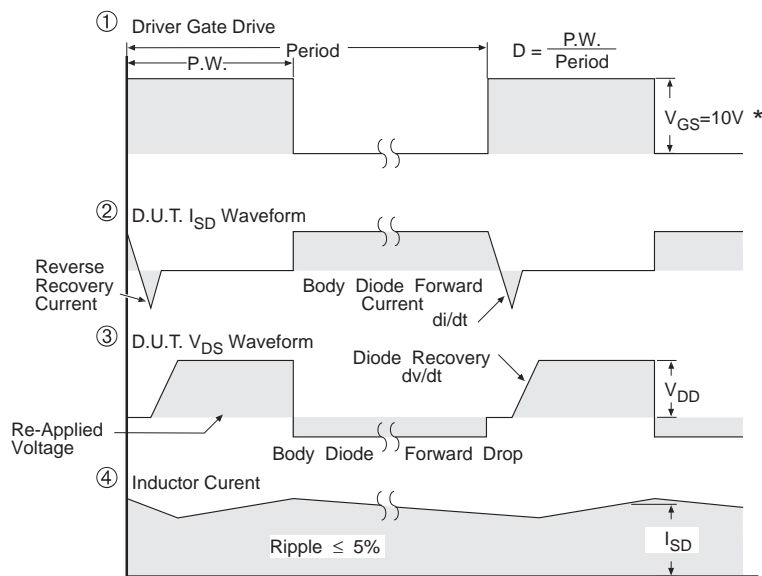
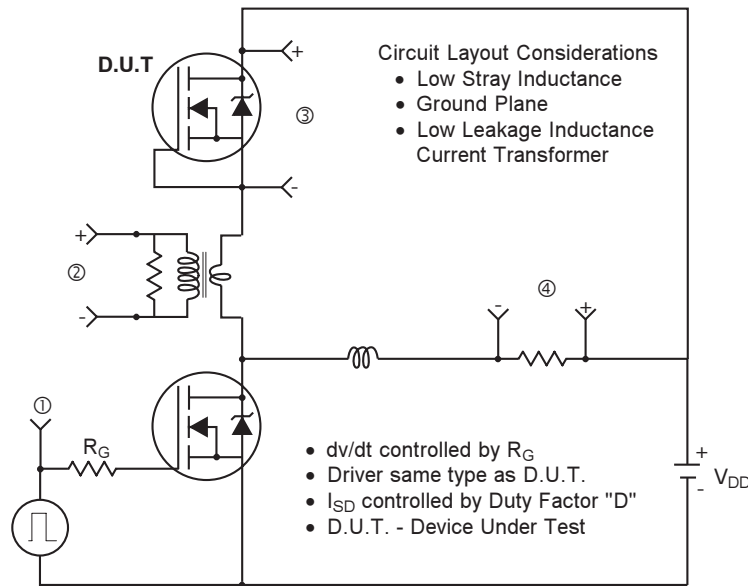


**Fig 15a.** Gate Charge Test Circuit



**Fig 15b.** Basic Gate Charge Waveform

## Peak Diode Recovery dv/dt Test Circuit



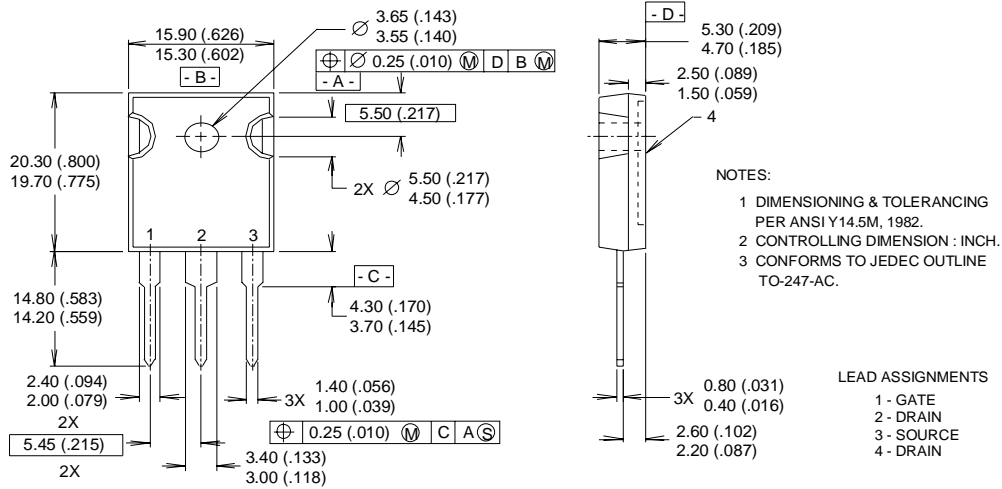
\*  $V_{GS} = 5V$  for Logic Level Devices

**Fig 16.** For N-Channel HEXFET<sup>®</sup> Power MOSFETs



## TO-247AC Package Outline

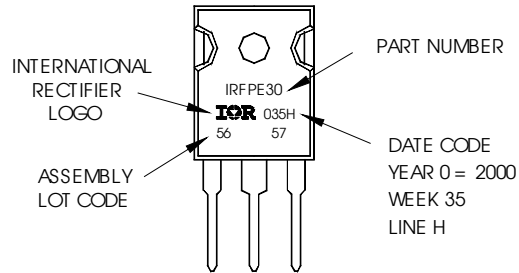
Dimensions are shown in millimeters (inches)



## TO-247AC Part Marking Information

Notes: This part marking information applies to devices produced after 02/26/2001

EXAMPLE: THIS IS AN IRFPE30  
 WITH ASSEMBLY  
 LOT CODE 5657  
 ASSEMBLED ON WW 35, 2000  
 IN THE ASSEMBLY LINE "H"



**TO-247AC package is not recommended for Surface Mount Application.**

Data and specifications subject to change without notice.  
 This product has been designed and qualified for the Industrial market.  
 Qualification Standards can be found on IR's Web site.