

> Features

- High Speed Switching
- Low On-Resistance
- No Secondary Breakdown
- Low Driving Power
- High Voltage
- $V_{GS} = \pm 30V$  Guarantee
- Repetitive Avalanche Rated

> Applications

- Switching Regulators
- UPS
- DC-DC converters
- General Purpose Power Amplifier

> Outline Drawing

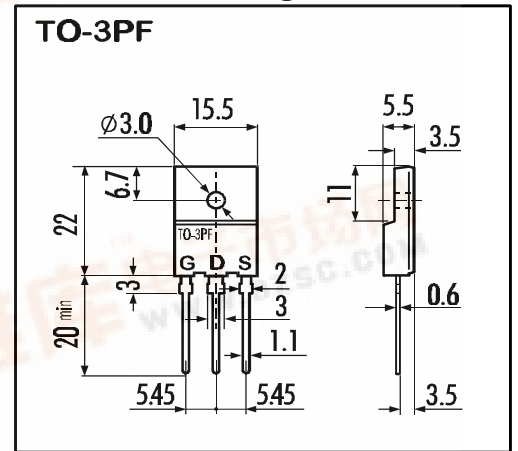

> Maximum Ratings and Characteristics

- Absolute Maximum Ratings ( $T_C=25^\circ C$ ), unless otherwise specified

Item	Symbol	Rating	Unit
Drain-Source-Voltage	$V_{DS}$	600	V
Continous Drain Current	$I_D$	9	A
Pulsed Drain Current	$I_{D(puls)}$	32	A
Gate-Source-Voltage	$V_{GS}$	$\pm 30$	V
Repetitive or Non-Repetitive ( $T_{ch} \leq 150^\circ C$ )	$I_{AR}$	9	A
Avalanche Energy	$E_{AS}$	117,6	mJ
Max. Power Dissipation	$P_D$	60	W
Operating and Storage Temperature Range	$T_{ch}$	150	$^\circ C$
	$T_{stg}$	-55 ~ +150	$^\circ C$

> Equivalent Circuit

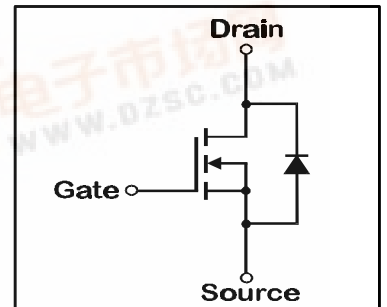

- Electrical Characteristics ( $T_C=25^\circ C$ ), unless otherwise specified

Item	Symbol	Test conditions	Min.	Typ.	Max.	Unit
Drain-Source Breakdown-Voltage	$V_{(BR)DSS}$	$I_D=1mA$ $V_{GS}=0V$	600			V
Gate Threshold Voltage	$V_{GS(th)}$	$I_D=1mA$ $V_{DS}=V_{GS}$	3,5	4,0	4,5	V
Zero Gate Voltage Drain Current	$I_{DSS}$	$V_{DS}=600V$ $T_{ch}=25^\circ C$		10	500	$\mu A$
		$V_{GS}=0V$ $T_{ch}=125^\circ C$		0,2	1,0	mA
Gate Source Leakage Current	$I_{GSS}$	$V_{GS}=\pm 30V$ $V_{DS}=0V$		10	100	nA
Drain Source On-State Resistance	$R_{DS(on)}$	$I_D=4A$ $V_{GS}=10V$		1,0	1,2	$\Omega$
Forward Transconductance	$g_{fs}$	$I_D=4A$ $V_{DS}=25V$	2,5	5		S
Input Capacitance	$C_{iss}$	$V_{DS}=25V$		900	1400	pF
Output Capacitance	$C_{oss}$	$V_{GS}=0V$		150	230	pF
Reverse Transfer Capacitance	$C_{rss}$	$f=1MHz$		70	110	pF
Turn-On-Time $t_{on}$ ( $t_{on}=t_{d(on)}+t_r$ )	$t_{d(on)}$	$V_{CC}=300V$		25	40	ns
	$t_r$	$I_D=9A$		70	110	ns
Turn-Off-Time $t_{off}$ ( $t_{off}=t_{d(off)}+t_f$ )	$t_{d(off)}$	$V_{GS}=10V$		60	90	ns
	$t_f$	$R_{GS}=10\Omega$		35	60	ns
Avalanche Capability	$I_{AV}$	$L=100\mu H$ $T_{ch}=25^\circ C$	9			A
Diode Forward On-Voltage	$V_{SD}$	$I_F=2I_{DR}$ $V_{GS}=0V$ $T_{ch}=25^\circ C$		1,0	1,50	V
Reverse Recovery Time	$t_{rr}$	$I_F=I_{DR}$ $V_{GS}=0V$		550		ns
Reverse Recovery Charge	$Q_{rr}$	$-di_F/dt=100A/\mu s$ $T_{ch}=25^\circ C$		7,0		$\mu C$

- Thermal Characteristics

Item	Symbol	Test conditions	Min.	Typ.	Max.	Unit
Thermal Resistance	$R_{th(ch-a)}$	channel to air			30	$^\circ C/W$
	$R_{th(ch-c)}$	channel to case			2,08	$^\circ C/W$



N-channel MOS-FET			
600V	1,2Ω	9A	60W

# 2SK2760-01

## FAP-IIS Series



### > Characteristics

Typical Output Characteristics  
 $I_D = f(V_{DS})$ ; 80μs pulse test;  $T_{ch} = 25^\circ\text{C}$

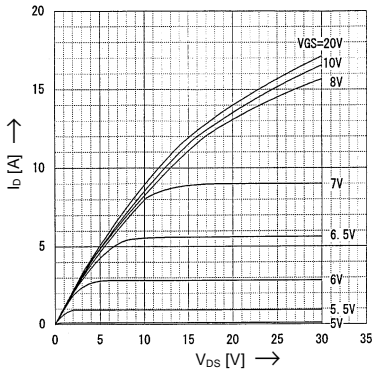

Drain-Source On-State Resistance vs.  $T_{ch}$   
 $R_{DS(on)} = f(T_{ch})$ ;  $I_D = 4\text{A}$ ;  $V_{GS} = 10\text{V}$

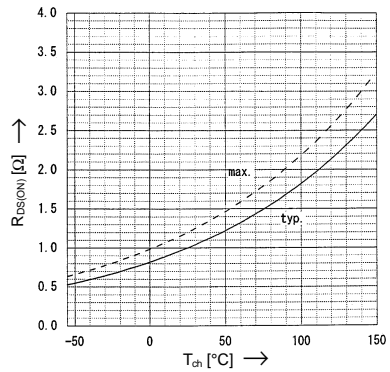

Typical Transfer Characteristics  
 $I_D = f(V_{GS})$ ; 80μs pulse test;  $V_{DS} = 25\text{V}$ ;  $T_{ch} = 25^\circ\text{C}$

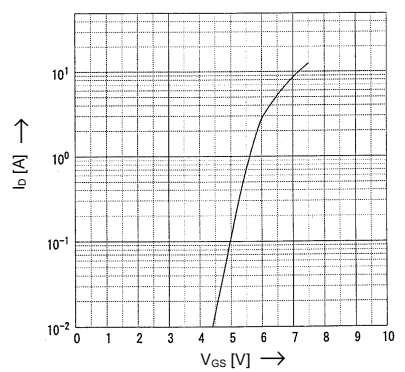

Typical Drain-Source On-State-Resistance vs.  $I_D$   
 $R_{DS(on)} = f(I_D)$ ; 80μs pulse test;  $T_{ch} = 25^\circ\text{C}$

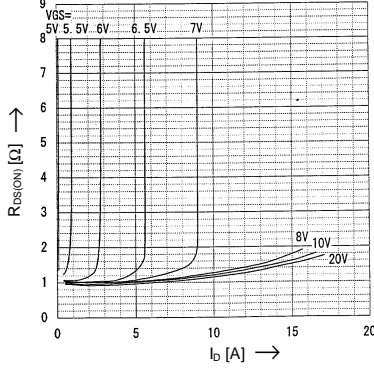

Typical Forward Transconductance vs.  $I_D$   
 $g_m = f(I_D)$ ; 80μs pulse test;  $V_{DS} = 25\text{V}$ ;  $T_{ch} = 25^\circ\text{C}$

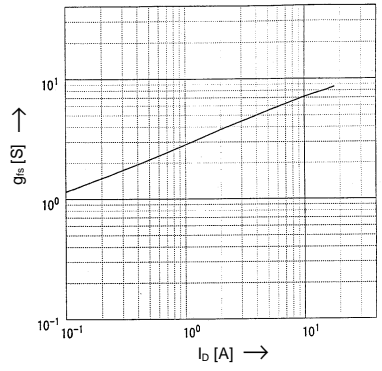

Gate Threshold Voltage vs.  $T_{ch}$   
 $V_{GS(th)} = f(T_{ch})$ ;  $I_D = 1\text{mA}$ ;  $V_{DS} = V_{GS}$

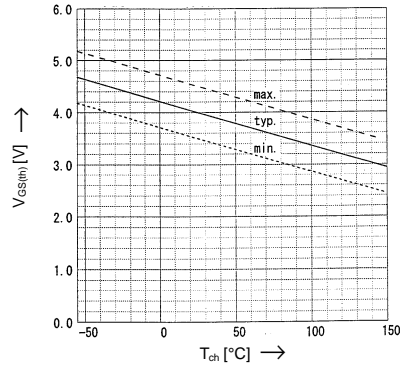

Typical Capacitances vs.  $V_{DS}$   
 $C = f(V_{DS})$ ;  $V_{GS} = 0\text{V}$ ;  $f = 1\text{MHz}$

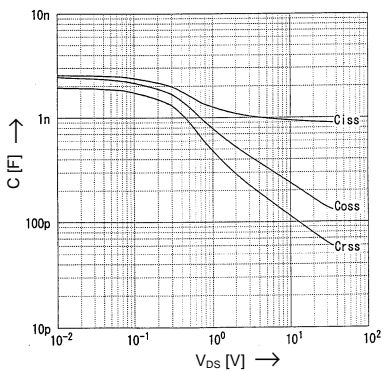

Typical Gate Charge Characteristic  
 $V_{GS} = f(Q_g)$ ;  $I_D = 9\text{A}$ ;  $T_{ch} = 25^\circ\text{C}$

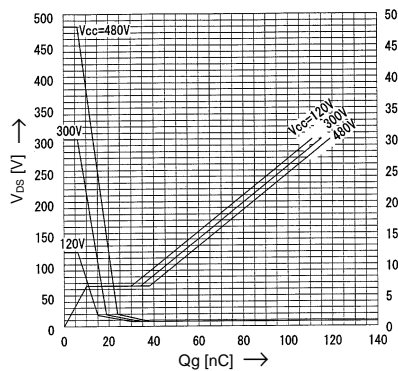

Forward Characteristics of Reverse Diode  
 $I_F = f(V_{SD})$ ; 80μs pulse test;  $V_{GS} = 0\text{V}$

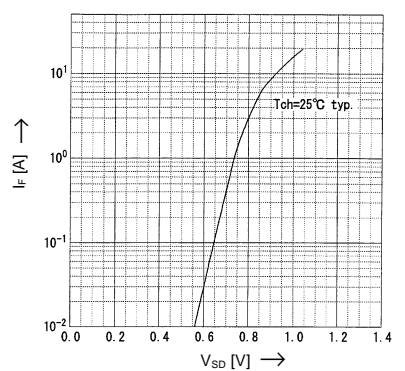

Avalanche Energy Derating  
 $E_{as} = f(\text{starting } T_{ch})$ ;  $V_{CC} = 60\text{V}$ ;  $I_{AV} = 9\text{A}$

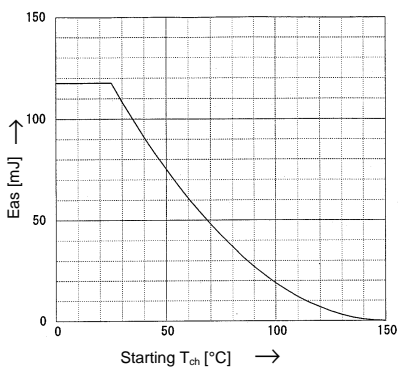

Safe Operation Area  
 $I_D = f(V_{DS})$ ;  $D = 0.01$ ;  $T_{ch} = 25^\circ\text{C}$

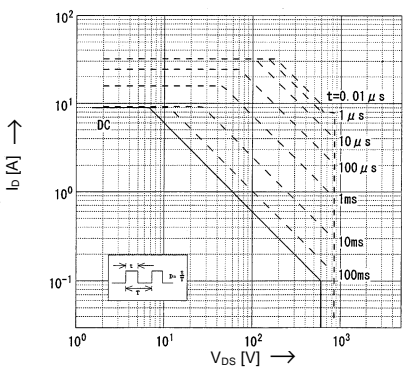

Transient Thermal Impedance  
 $Z_{th(jc)} = f(t)$  parameter:  $D = t/T$

