

TLV2361, TLV2361Y, TLV2362, TLV2362Y HIGH-PERFORMANCE LOW-VOLTAGE OPERATIONAL AMPLIFIERS

SLOS195B – FEBRUARY 1997 – REVISED OCTOBER 1998

- **Low Supply-Voltage Operation . . . $V_{CC} = \pm 1$ V Min**
- **Wide Bandwidth . . . 7 MHz Typ at $V_{CC\pm} = \pm 2.5$ V**
- **High Slew Rate . . . 3 V/ μ s Typ at $V_{CC\pm} = \pm 2.5$ V**
- **Wide Output Voltage Swing . . . ± 2.4 V Typ at $V_{CC\pm} = \pm 2.5$ V, $R_L = 10$ k Ω**
- **Low Noise . . . 8 nV/ $\sqrt{\text{Hz}}$ Typ at $f = 1$ kHz**
- **Package Options Include SOT-23 (DBV) Package for the TLV2361 and Plastic Small-Outline (D), Thin Shrink Small-Outline (PW), and Dual-In-Line (P) Packages for the TLV2362**

TLV2361 . . . DBV PACKAGE (TOP VIEW)

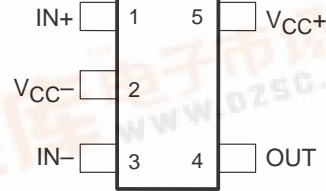

TLV2362 . . . D, P, OR PW PACKAGE (TOP VIEW)

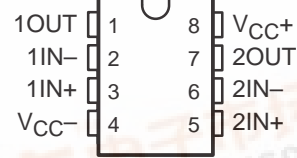

description

The TLV236x devices are high-performance dual operational amplifiers built using an original Texas Instruments bipolar process. These devices can be operated at a very low supply voltage (± 1 V), while maintaining a wide output swing. The TLV236x devices offer a dramatically improved dynamic range of signal conditioning in low-voltage systems. The TLV236x devices also provide higher performance than other general-purpose operational amplifiers by combining higher unity-gain bandwidth and faster slew rate. With their low distortion and low-noise performance, these devices are well suited for audio applications.

The C-suffix devices are characterized for operation from 0°C to 70°C and the I-suffix devices are characterized for operation from -40°C to 85°C.

TLV2361 AVAILABLE OPTIONS

T _A	PACKAGED DEVICES		SYMBOL	CHIP FORM‡ (Y)
	SOT-23 (DBV)†			
0°C to 70°C	TLV2361CDBV		VAAC	TLV2361Y
-40°C to 85°C	TLV2361IDBV		VAAI	

† The DBV packages are only available taped and reeled.

‡ Chip forms are specified for operation at 25°C only.

TLV2362 AVAILABLE OPTIONS

T _A	PACKAGED DEVICES			CHIP FORM‡ (Y)
	SMALL OUTLINE§ (D)	PLASTIC DIP (P)	TSSOP¶ (PW)	
-20°C to 85°C	TLV2362ID	TLV2362IP	TLV2362IPWR	TLV2362Y

‡ Chip forms are specified for operation at 25°C only.

§ The D packages are available taped and reeled. Add an R to the package suffix (e.g., TLV2362IDR).

¶ The PW packages are available left-ended taped and reeled only, (e.g., TLV2362IPWR).

Please be aware that an important notice concerning availability, standard warranty, and use in critical applications of Texas Instruments semiconductor products and disclaimers thereto appears at the end of this data sheet.

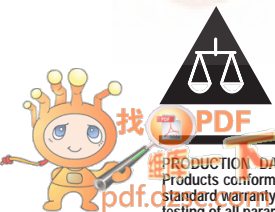

TLV2361, TLV2361Y, TLV2362, TLV2362Y HIGH-PERFORMANCE LOW-VOLTAGE OPERATIONAL AMPLIFIERS

SLOS195B – FEBRUARY 1997 – REVISED OCTOBER 1998

equivalent schematic (each amplifier)

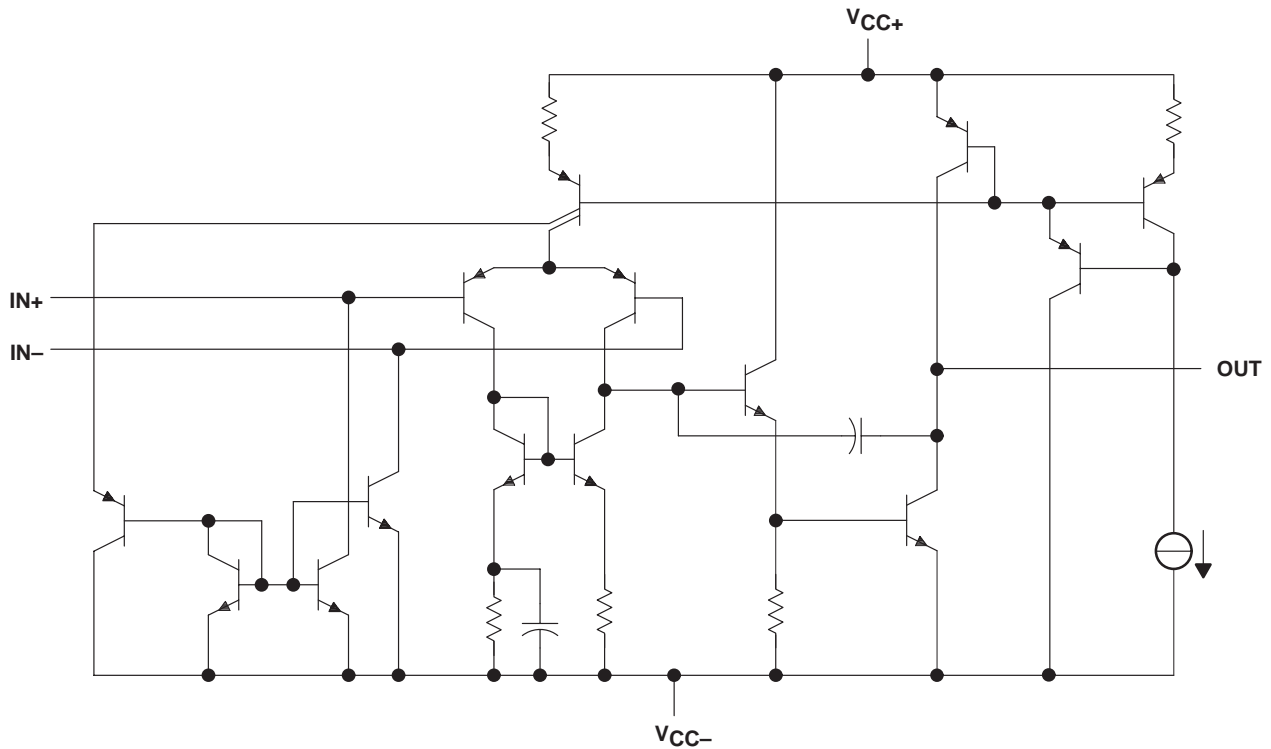

ACTUAL DEVICE COMPONENT COUNT		
COMPONENT	TLV2361	TLV2362
Transistors	30	46
Resistors	6	11
Diodes	1	1
Capacitors	2	4
JFET	1	1

TLV2361, TLV2361Y, TLV2362, TLV2362Y HIGH-PERFORMANCE LOW-VOLTAGE OPERATIONAL AMPLIFIERS

SLOS195B – FEBRUARY 1997 – REVISED OCTOBER 1998

TLV2361Y chip information

This chip, when properly assembled, has characteristics similar to the TLV2361. Thermal compression or ultrasonic bonding can be used on the doped-aluminum bonding pads. This chip can be mounted with conductive epoxy or a gold-silicon preform.

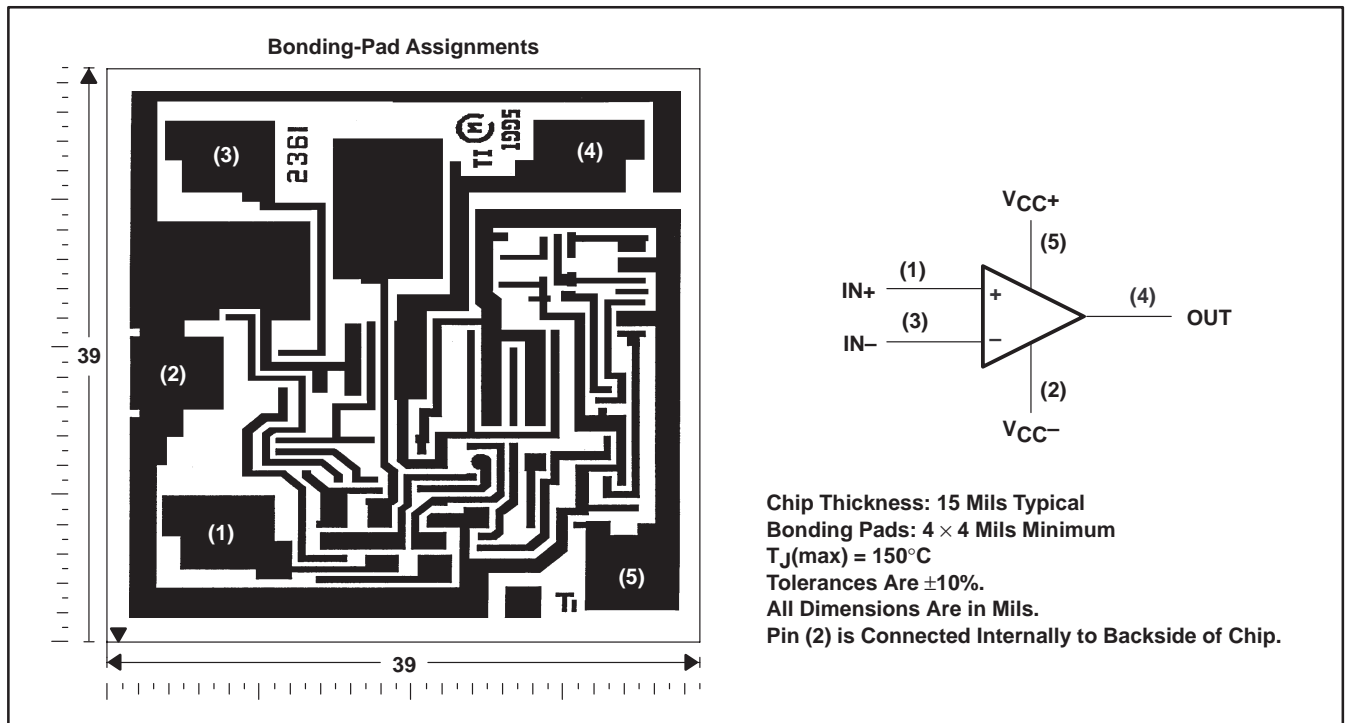

TLV2361, TLV2361Y, TLV2362, TLV2362Y HIGH-PERFORMANCE LOW-VOLTAGE OPERATIONAL AMPLIFIERS

SLOS195B – FEBRUARY 1997 – REVISED OCTOBER 1998

TLV2362Y chip information

This chip, when properly assembled, has characteristics similar to the TLV2362. Thermal compression or ultrasonic bonding can be used on the doped-aluminum bonding pads. Chips can be mounted with conductive epoxy or a gold-silicon preform.

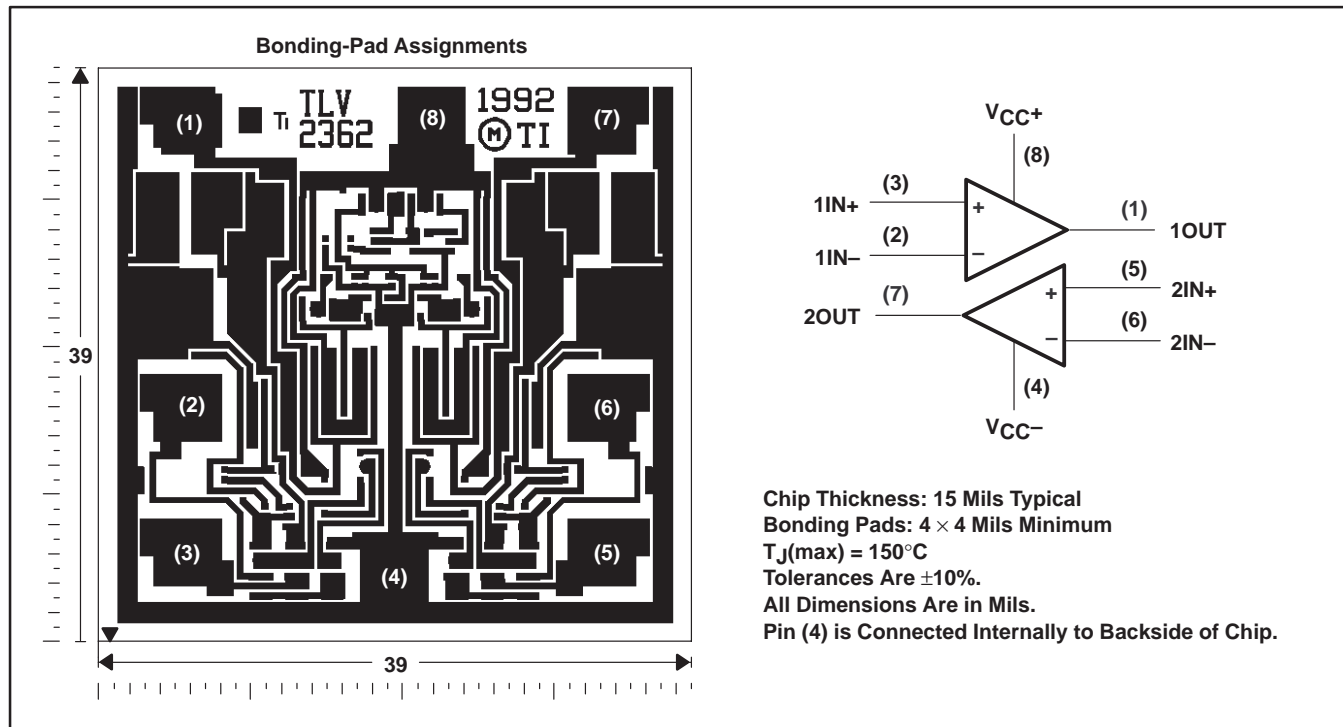

TLV2361, TLV2361Y, TLV2362, TLV2362Y HIGH-PERFORMANCE LOW-VOLTAGE OPERATIONAL AMPLIFIERS

SLOS195B – FEBRUARY 1997 – REVISED OCTOBER 1998

absolute maximum ratings over operating free-air temperature range (unless otherwise noted)†

Supply voltage, V_{CC+} (see Note 1)	3.5 V
Supply voltage, V_{CC-} (see Note 1)	–3.5 V
Differential input voltage, V_{ID} (see Note 2)	± 3.5 V
Input voltage, V_I (any input) (see Notes 1 and 3)	$V_{CC\pm}$
Output voltage, V_O	± 3.5 V
Output current, I_O	20 mA
Duration of short-circuit current at (or below) 25°C (output shorted to GND)	Unlimited
Package thermal impedance, θ_{JA} (see Note 4): D package	197°C/W
DBV package	347°C/W
P package	104°C/W
PW package	243°C/W
Storage temperature range, T_{stg}	–65°C to 150°C
Lead temperature 1,6 mm (1/16 inch) from case for 10 seconds	260°C

† Stresses beyond those listed under “absolute maximum ratings” may cause permanent damage to the device. These are stress ratings only, and functional operation of the device at these or any other conditions beyond those indicated under “recommended operating conditions” is not implied. Exposure to absolute-maximum-rated conditions for extended periods may affect device reliability.

- NOTES:
1. All voltage values, except differential voltages, are with respect to the midpoint between V_{CC+} and V_{CC-} .
 2. Differential voltages are at $IN+$ with respect to $IN-$.
 3. All input voltage values must not exceed V_{CC} .
 4. The package thermal impedance is calculated in accordance with JESD 51, except for through-hole packages, which use a trace length of zero.

recommended operating conditions

	C SUFFIX		I SUFFIX		UNIT
	MIN	MAX	MIN	MAX	
Supply voltage, V_{CC}	± 1	± 2.5	± 1	± 2.5	V
Operating free-air temperature, T_A	0	70	–40	85	°C

TLV2361, TLV2361Y, TLV2362, TLV2362Y HIGH-PERFORMANCE LOW-VOLTAGE OPERATIONAL AMPLIFIERS

SLOS195B – FEBRUARY 1997 – REVISED OCTOBER 1998

TLV2361C electrical characteristics, $V_{CC\pm} = \pm 1.5\text{ V}$ (unless otherwise noted)

PARAMETER	TEST CONDITIONS	T_A	TLV2361C			UNIT
			MIN	TYP	MAX	
V_{IO} Input offset voltage	$V_O = 0, V_{IC} = 0$	25°C		1	6	mV
		0°C to 70°C			7.5	
I_{IO} Input offset current	$V_O = 0, V_{IC} = 0$	25°C		5	100	nA
		0°C to 70°C			150	
I_{IB} Input bias current	$V_O = 0, V_{IC} = 0$	25°C		20	150	nA
		0°C to 70°C			250	
V_{IC} Common-mode input voltage	$ V_{IO} \leq 7.5\text{ mV}$	25°C		± 0.5		V
		0°C to 70°C		± 0.5		
V_{OM+} Maximum positive-peak output voltage	$R_L = 10\text{ k}\Omega$	25°C	1.2	1.4		V
	$R_L \geq 10\text{ k}\Omega$	0°C to 70°C	1.2			
V_{OM-} Maximum negative-peak output voltage	$R_L = 10\text{ k}\Omega$	25°C	-1.2	-1.4		V
	$R_L \geq 10\text{ k}\Omega$	0°C to 70°C	-1.2			
I_{CC} Supply current (package)	$V_O = 0, \text{ No load}$	25°C		1.4	2.25	mA
		0°C to 70°C			2.75	
A_{VD} Large-signal differential voltage amplification	$V_O = \pm 1\text{ V}, R_L = 10\text{ k}\Omega$	25°C	60	80		dB
CMRR Common-mode rejection ratio	$V_{IC} = \pm 0.5\text{ V}$	25°C		75		dB
k_{SVR} Supply-voltage rejection ratio	$V_{CC\pm} = \pm 1.5\text{ V to } \pm 2.5\text{ V}$	25°C		80		dB

TLV2361C operating characteristics, $V_{CC\pm} = \pm 1.5\text{ V}, T_A = 25^\circ\text{C}$

PARAMETER	TEST CONDITIONS	TLV2361C			UNIT
		MIN	TYP	MAX	
SR Slew rate	$A_V = 1, V_I = \pm 0.5\text{ V}$		2.5		V/ μs
B_1 Unity-gain bandwidth	$A_V = 40, R_L = 10\text{ k}\Omega, C_L = 100\text{ pF}$		6		MHz
V_n Equivalent input noise voltage	$R_S = 100\ \Omega, R_F = 10\text{ k}\Omega, f = 1\text{ kHz}$		9		nV/ $\sqrt{\text{Hz}}$

TLV2361, TLV2361Y, TLV2362, TLV2362Y

HIGH-PERFORMANCE LOW-VOLTAGE OPERATIONAL AMPLIFIERS

SLOS195B – FEBRUARY 1997 – REVISED OCTOBER 1998

TLV2361C electrical characteristics, $V_{CC\pm} = \pm 2.5\text{ V}$ (unless otherwise noted)

PARAMETER		TEST CONDITIONS	T_A	TLV2361C			UNIT
				MIN	TYP	MAX	
V_{IO}	Input offset voltage	$V_O = 0, V_{IC} = 0$	25°C	1	6	mV	
			0°C to 70°C		7.5		
I_{IO}	Input offset current	$V_O = 0, V_{IC} = 0$	25°C	5	100	nA	
			0°C to 70°C		150		
I_{IB}	Input bias current	$V_O = 0, V_{IC} = 0$	25°C	20	150	nA	
			0°C to 70°C		250		
V_{IC}	Common-mode input voltage	$ V_{IO} \leq 7.5\text{ mV}$	25°C	± 1.5		V	
			0°C to 70°C	± 1.4			
V_{OM+}	Maximum positive-peak output voltage	$R_L = 10\text{ k}\Omega$	25°C	2	2.4	V	
		$R_L \geq 10\text{ k}\Omega$	0°C to 70°C	2			
V_{OM-}	Maximum negative-peak output voltage	$R_L = 10\text{ k}\Omega$	25°C	-2	-2.4	V	
		$R_L \geq 10\text{ k}\Omega$	0°C to 70°C	-2			
I_{CC}	Supply current (package)	$V_O = 0, \text{ No load}$	25°C	1.75	2.5	mA	
			0°C to 70°C	3			
A_{VD}	Large-signal differential voltage amplification	$V_O = \pm 1\text{ V}, R_L = 10\text{ k}\Omega$	25°C	60	80	dB	
CMRR	Common-mode rejection ratio	$V_{IC} = \pm 0.5\text{ V}$	25°C	85		dB	
kSVR	Supply-voltage rejection ratio	$V_{CC\pm} = \pm 1.5\text{ V to } \pm 2.5\text{ V}$	25°C	80		dB	

TLV2361C operating characteristics, $V_{CC\pm} = \pm 2.5\text{ V}, T_A = 25^\circ\text{C}$

PARAMETER		TEST CONDITIONS	TLV2361C			UNIT
			MIN	TYP	MAX	
SR	Slew rate	$A_V = 1, V_I = \pm 0.5\text{ V}$		3		V/ μs
B_1	Unity-gain bandwidth	$A_V = 40, R_L = 10\text{ k}\Omega, C_L = 100\text{ pF}$		7		MHz
V_n	Equivalent input noise voltage	$R_S = 100\ \Omega, R_F = 10\text{ k}\Omega, f = 1\text{ kHz}$		8		nV/ $\sqrt{\text{Hz}}$
THD + N	Total harmonic distortion plus noise	$A_V = 1, f = 3\text{ kHz}, V_O = \pm 1.2\text{ V}, R_L = 10\text{ k}\Omega$		0.004%		

TLV2361, TLV2361Y, TLV2362, TLV2362Y HIGH-PERFORMANCE LOW-VOLTAGE OPERATIONAL AMPLIFIERS

SLOS195B – FEBRUARY 1997 – REVISED OCTOBER 1998

TLV2361I electrical characteristics, $V_{CC\pm} = \pm 1.5\text{ V}$ (unless otherwise noted)

PARAMETER	TEST CONDITIONS	T _A	TLV2361I			UNIT
			MIN	TYP	MAX	
V _{IO} Input offset voltage	V _O = 0, V _{IC} = 0	25°C		1	6	mV
		-40°C to 85°C			7.5	
I _{IO} Input offset current	V _O = 0, V _{IC} = 0	25°C		5	100	nA
		-40°C to 85°C			150	
I _{IB} Input bias current	V _O = 0, V _{IC} = 0	25°C		20	150	nA
		-40°C to 85°C			250	
V _{IC} Common-mode input voltage	V _{IO} ≤ 7.5 mV	25°C	±0.5			V
		-40°C to 85°C	±0.5			
V _{OM+} Maximum positive-peak output voltage	R _L = 10 kΩ	25°C	1.2	1.4		V
	R _L ≥ 10 kΩ	-40°C to 85°C	1.2			
V _{OM-} Maximum negative-peak output voltage	R _L = 10 kΩ	25°C	-1.2	-1.4		V
	R _L ≥ 10 kΩ	-40°C to 85°C	-1.2			
I _{CC} Supply current (package)	V _O = 0, No load	25°C		1.4	2.25	mA
		-40°C to 85°C			2.75	
A _{VD} Large-signal differential voltage amplification	V _O = ±1 V, R _L = 10 kΩ	25°C	60	80		dB
CMRR Common-mode rejection ratio	V _{IC} = ±0.5 V	25°C		75		dB
k _{SVR} Supply-voltage rejection ratio	V _{CC±} = ±1.5 V to ±2.5 V	25°C		80		dB

TLV2361I operating characteristics, $V_{CC\pm} = \pm 1.5\text{ V}$, T_A = 25°C

PARAMETER	TEST CONDITIONS	TLV2361I			UNIT
		MIN	TYP	MAX	
SR Slew rate	A _V = 1, V _I = ±0.5 V		2.5		V/μs
B ₁ Unity-gain bandwidth	A _V = 40, R _L = 10 kΩ, C _L = 100 pF		6		MHz
V _n Equivalent input noise voltage	R _S = 100 Ω, R _F = 10 kΩ, f = 1 kHz		9		nV/√Hz

TLV2361, TLV2361Y, TLV2362, TLV2362Y

HIGH-PERFORMANCE LOW-VOLTAGE OPERATIONAL AMPLIFIERS

SLOS195B – FEBRUARY 1997 – REVISED OCTOBER 1998

TLV2361I electrical characteristics, $V_{CC\pm} = \pm 2.5$ V (unless otherwise noted)

PARAMETER	TEST CONDITIONS	T _A	TLV2361I			UNIT
			MIN	TYP	MAX	
V _{IO} Input offset voltage	V _O = 0, V _{IC} = 0	25°C		1	6	mV
		-40°C to 85°C			7.5	
I _{IO} Input offset current	V _O = 0, V _{IC} = 0	25°C		5	100	nA
		-40°C to 85°C			150	
I _{IB} Input bias current	V _O = 0, V _{IC} = 0	25°C		20	150	nA
		-40°C to 85°C			250	
V _{IC} Common-mode input voltage	V _{IO} ≤ 7.5 mV	25°C	±1.5		V	
		-40°C to 85°C	±1.4			
V _{OM+} Maximum positive-peak output voltage	R _L = 10 kΩ	25°C	2	2.4	V	
	R _L ≥ 10 kΩ	-40°C to 85°C	2			
V _{OM-} Maximum negative-peak output voltage	R _L = 10 kΩ	25°C	-2	-2.4	V	
	R _L ≥ 10 kΩ	-40°C to 85°C	-2			
I _{CC} Supply current (package)	V _O = 0, No load	25°C	1.75	2.5	mA	
		-40°C to 85°C	3			
A _{VD} Large-signal differential voltage amplification	V _O = ±1 V, R _L = 10 kΩ	25°C	60	80	dB	
CMRR Common-mode rejection ratio	V _{IC} = ±0.5 V	25°C	85		dB	
k _{SVR} Supply-voltage rejection ratio	V _{CC±} = ±1.5 V to ±2.5 V	25°C	80		dB	

TLV2361I operating characteristics, $V_{CC\pm} = \pm 2.5$ V, T_A = 25°C

PARAMETER	TEST CONDITIONS	TLV2361I			UNIT
		MIN	TYP	MAX	
SR Slew rate	A _V = 1, V _I = ±0.5 V		3		V/μs
B ₁ Unity-gain bandwidth	A _V = 40, R _L = 10 kΩ, C _L = 100 pF		7		MHz
V _n Equivalent input noise voltage	R _S = 100 Ω, R _F = 10 kΩ, f = 1 kHz		8		nV/√Hz

TLV2361, TLV2361Y, TLV2362, TLV2362Y

HIGH-PERFORMANCE LOW-VOLTAGE OPERATIONAL AMPLIFIERS

SLOS195B – FEBRUARY 1997 – REVISED OCTOBER 1998

TLV2361Y electrical characteristics, $V_{CC\pm} = \pm 1.5\text{ V}$, $T_A = 25^\circ\text{C}$ (unless otherwise noted)

PARAMETER		TEST CONDITIONS		TLV2361Y			UNIT
				MIN	TYP	MAX	
V_{IO}	Input offset voltage	$V_O = 0,$	$V_{IC} = 0$		1		mV
I_{IO}	Input offset current	$V_O = 0,$	$V_{IC} = 0$		5		nA
I_{IB}	Input bias current	$V_O = 0,$	$V_{IC} = 0$		20		nA
V_{OM+}	Maximum positive-peak output voltage	$R_L = 10\text{ k}\Omega$			1.4		V
V_{OM-}	Maximum negative-peak output voltage	$R_L = 10\text{ k}\Omega$			-1.4		V
I_{CC}	Supply current	$V_O = 0,$	No load		1.4		mA
A_{VD}	Large-signal differential voltage amplification	$V_O = \pm 1\text{ V},$	$R_L = 10\text{ k}\Omega$		80		dB
CMRR	Common-mode rejection ratio	$V_{IC} = \pm 0.5\text{ V}$			75		dB
kSVR	Supply-voltage rejection ratio	$V_{CC\pm} = \pm 1.5\text{ V to } \pm 2.5\text{ V}$			80		dB

TLV2361Y operating characteristics, $V_{CC\pm} = \pm 1.5\text{ V}$, $T_A = 25^\circ\text{C}$

PARAMETER		TEST CONDITIONS			TLV2361Y			UNIT
					MIN	TYP	MAX	
SR	Slew rate	$A_V = 1,$	$V_I = \pm 0.5\text{ V}$			2.5		V/ μs
B_1	Unity-gain bandwidth	$A_V = 40,$	$R_L = 10\text{ k}\Omega,$	$C_L = 100\text{ pF}$		6		MHz
V_n	Equivalent input noise voltage	$R_S = 100\ \Omega,$	$R_F = 10\text{ k}\Omega,$	$f = 1\text{ kHz}$		9		nV/ $\sqrt{\text{Hz}}$

TLV2361Y electrical characteristics, $V_{CC\pm} = \pm 2.5\text{ V}$, $T_A = 25^\circ\text{C}$ (unless otherwise noted)

PARAMETER		TEST CONDITIONS		TLV2361Y			UNIT
				MIN	TYP	MAX	
V_{IO}	Input offset voltage	$V_O = 0,$	$V_{IC} = 0$		1		mV
I_{IO}	Input offset current	$V_O = 0,$	$V_{IC} = 0$		5		nA
I_{IB}	Input bias current	$V_O = 0,$	$V_{IC} = 0$		20		nA
V_{OM+}	Maximum positive-peak output voltage	$R_L = 10\text{ k}\Omega$			2.4		V
V_{OM-}	Maximum negative-peak output voltage	$R_L = 10\text{ k}\Omega$			-2.4		V
I_{CC}	Supply current	$V_O = 0,$	No load		1.75		mA
A_{VD}	Large-signal differential voltage amplification	$V_O = \pm 1\text{ V},$	$R_L = 10\text{ k}\Omega$		80		dB
CMRR	Common-mode rejection ratio	$V_{IC} = \pm 0.5\text{ V}$			85		dB
kSVR	Supply-voltage rejection ratio	$V_{CC\pm} = \pm 1.5\text{ V to } \pm 2.5\text{ V}$			80		dB

TLV2361Y operating characteristics, $V_{CC\pm} = \pm 2.5\text{ V}$, $T_A = 25^\circ\text{C}$

PARAMETER		TEST CONDITIONS			TLV2361Y			UNIT
					MIN	TYP	MAX	
SR	Slew rate	$A_V = 1,$	$V_I = \pm 0.5\text{ V}$			3		V/ μs
B_1	Unity-gain bandwidth	$A_V = 40,$	$R_L = 10\text{ k}\Omega,$	$C_L = 100\text{ pF}$		7		MHz
V_n	Equivalent input noise voltage	$R_S = 100\ \Omega,$	$R_F = 10\text{ k}\Omega,$	$f = 1\text{ kHz}$		8		nV/ $\sqrt{\text{Hz}}$

TLV2361, TLV2361Y, TLV2362, TLV2362Y

HIGH-PERFORMANCE LOW-VOLTAGE OPERATIONAL AMPLIFIERS

SLOS195B – FEBRUARY 1997 – REVISED OCTOBER 1998

TLV2362I electrical characteristics, $V_{CC\pm} = \pm 1.5\text{ V}$ (unless otherwise noted)

PARAMETER	TEST CONDITIONS	T_A	TLV2362I			UNIT
			MIN	TYP	MAX	
V_{IO} Input offset voltage	$V_O = 0, V_{IC} = 0$	25°C		1	6	mV
		-20°C to 85°C			7.5	
I_{IO} Input offset current	$V_O = 0, V_{IC} = 0$	25°C		5	100	nA
		-20°C to 85°C			150	
I_{IB} Input bias current	$V_O = 0, V_{IC} = 0$	25°C		20	150	nA
		-20°C to 85°C			250	
V_{ICR} Common-mode input voltage	$ V_{IO} \leq 3.75\text{ mV}$	25°C		± 0.5		V
		-20°C to 85°C		± 0.5		
V_{OM+} Maximum positive-peak output voltage	$R_L = 10\text{ k}\Omega$	25°C		1.2	1.4	V
	$R_L \geq 10\text{ k}\Omega$	-20°C to 85°C		1.2		
V_{OM-} Maximum negative-peak output voltage	$R_L = 10\text{ k}\Omega$	25°C		-1.2	-1.4	V
	$R_L \geq 10\text{ k}\Omega$	-20°C to 85°C		-1.2		
I_{CC} Supply current (both amplifiers)	$V_O = 0, \text{ No load}$	25°C		2.8	4.5	mA
		-20°C to 85°C			5.5	
A_{VD} Large-signal differential voltage amplification	$V_O = \pm 1\text{ V}, R_L = 10\text{ k}\Omega$	25°C		55		dB
CMRR Common-mode rejection ratio	$V_{IC} = \pm 0.5\text{ V}$	25°C		75		dB
k_{SVR} Supply-voltage rejection ratio	$V_{CC\pm} = \pm 1.5\text{ V to } \pm 2.5\text{ V}$	25°C		80		dB

TLV2362I operating characteristics, $V_{CC\pm} = \pm 1.5\text{ V}, T_A = 25^\circ\text{C}$

PARAMETER	TEST CONDITIONS	TLV2362I			UNIT
		MIN	TYP	MAX	
SR Slew rate	$A_V = 1, V_I = \pm 0.5\text{ V}$		2.5		V/ μs
B_1 Unity-gain bandwidth	$A_V = 40, R_L = 10\text{ k}\Omega, C_L = 100\text{ pF}$		6		MHz
V_n Equivalent input noise voltage	$R_S = 100\ \Omega, R_F = 10\text{ k}\Omega, f = 1\text{ kHz}$		9		nV/ $\sqrt{\text{Hz}}$

TLV2361, TLV2361Y, TLV2362, TLV2362Y

HIGH-PERFORMANCE LOW-VOLTAGE OPERATIONAL AMPLIFIERS

SLOS195B – FEBRUARY 1997 – REVISED OCTOBER 1998

TLV2362I electrical characteristics, $V_{CC\pm} = \pm 2.5$ V (unless otherwise noted)

PARAMETER	TEST CONDITIONS	T_A	TLV2362I			UNIT
			MIN	TYP	MAX	
V_{IO} Input offset voltage	$V_O = 0, V_{IC} = 0$	25°C		1	6	mV
		-20°C to 85°C			7.5	
I_{IO} Input offset current	$V_O = 0, V_{IC} = 0$	25°C		5	100	nA
		-20°C to 85°C			150	
I_{IB} Input bias current	$V_O = 0, V_{IC} = 0$	25°C		20	150	nA
		-20°C to 85°C			250	
V_{ICR} Common-mode input voltage	$ V_{IO} \leq 7.5$ mV	25°C		± 1.5		V
		-20°C to 85°C		± 1.4		
V_{OM+} Maximum positive-peak output voltage	$R_L = 10$ k Ω	25°C		2	2.4	V
	$R_L \geq 10$ k Ω	-20°C to 85°C		2		
V_{OM-} Maximum negative-peak output voltage	$R_L = 10$ k Ω	25°C		-2	-2.4	V
	$R_L \geq 10$ k Ω	-20°C to 85°C		-2		
I_{CC} Supply current (both amplifiers)	$V_O = 0, \text{ No load}$	25°C		3.5	5	mA
		-20°C to 85°C			6	
A_{VD} Large-signal differential voltage amplification	$V_O = \pm 1$ V, $R_L = 10$ k Ω	25°C		60		dB
CMRR Common-mode rejection ratio	$V_{IC} = \pm 0.5$ V	25°C		85		dB
k_{SVR} Supply-voltage rejection ratio	$V_{CC\pm} = \pm 1.5$ V to ± 2.5 V	25°C		80		dB

TLV2362I operating characteristics, $V_{CC\pm} = \pm 2.5$ V, $T_A = 25^\circ\text{C}$

PARAMETER	TEST CONDITIONS	TLV2362I			UNIT
		MIN	TYP	MAX	
SR Slew rate	$A_V = 1, V_I = \pm 0.5$ V		3		V/ μ s
B_1 Unity-gain bandwidth	$A_V = 40, R_L = 10$ k $\Omega, C_L = 100$ pF		7		MHz
V_n Equivalent input noise voltage	$R_S = 100$ $\Omega, R_F = 10$ k $\Omega, f = 1$ kHz		8		nV/ $\sqrt{\text{Hz}}$

TLV2361, TLV2361Y, TLV2362, TLV2362Y

HIGH-PERFORMANCE LOW-VOLTAGE OPERATIONAL AMPLIFIERS

SLOS195B – FEBRUARY 1997 – REVISED OCTOBER 1998

TLV2362Y electrical characteristics, $V_{CC\pm} = \pm 1.5\text{ V}$, $T_A = 25^\circ\text{C}$ (unless otherwise noted)

PARAMETER		TEST CONDITIONS		TLV2362Y			UNIT
				MIN	TYP	MAX	
V_{IO}	Input offset voltage	$V_O = 0$,	$V_{IC} = 0$		1		mV
I_{IO}	Input offset current	$V_O = 0$,	$V_{IC} = 0$		5		nA
I_{IB}	Input bias current	$V_O = 0$,	$V_{IC} = 0$		20		nA
V_{OM+}	Maximum positive-peak output voltage	$R_L = 10\text{ k}\Omega$			1.4		V
V_{OM-}	Maximum negative-peak output voltage	$R_L = 10\text{ k}\Omega$			-1.4		V
I_{CC}	Supply current (both amplifiers)	$V_O = 0$,	No load		2.8		mA
A_{VD}	Large-signal differential voltage amplification	$V_O = \pm 1\text{ V}$,	$R_L = 10\text{ k}\Omega$		55		dB
CMRR	Common-mode rejection ratio	$V_{IC} = \pm 0.5\text{ V}$			75		dB
kSVR	Supply-voltage rejection ratio	$V_{CC\pm} = \pm 1.5\text{ V to } \pm 2.5\text{ V}$			80		dB

TLV2362Y operating characteristics, $V_{CC\pm} = \pm 1.5\text{ V}$, $T_A = 25^\circ\text{C}$

PARAMETER		TEST CONDITIONS			TLV2362Y			UNIT
					MIN	TYP	MAX	
SR	Slew rate	$A_V = 1$,	$V_I = \pm 0.5\text{ V}$			2.5		V/ μs
B_1	Unity-gain bandwidth	$A_V = 40$,	$R_L = 10\text{ k}\Omega$,	$C_L = 100\text{ pF}$		6		MHz
V_n	Equivalent input noise voltage	$R_S = 100\ \Omega$,	$R_F = 10\text{ k}\Omega$,	$f = 1\text{ kHz}$		9		nV/ $\sqrt{\text{Hz}}$

TLV2362Y electrical characteristics, $V_{CC\pm} = \pm 2.5\text{ V}$, $T_A = 25^\circ\text{C}$ (unless otherwise noted)

PARAMETER		TEST CONDITIONS		TLV2362Y			UNIT
				MIN	TYP	MAX	
V_{IO}	Input offset voltage	$V_O = 0$,	$V_{IC} = 0$		1		mV
I_{IO}	Input offset current	$V_O = 0$,	$V_{IC} = 0$		5		nA
I_{IB}	Input bias current	$V_O = 0$,	$V_{IC} = 0$		20		nA
V_{OM+}	Maximum positive-peak output voltage	$R_L = 10\text{ k}\Omega$			2.4		V
V_{OM-}	Maximum negative-peak output voltage	$R_L = 10\text{ k}\Omega$			-2.4		V
I_{CC}	Supply current (both amplifiers)	$V_O = 0$,	No load		3.5		mA
A_{VD}	Large-signal differential voltage amplification	$V_O = \pm 1\text{ V}$,	$R_L = 10\text{ k}\Omega$		60		dB
CMRR	Common-mode rejection ratio	$V_{IC} = \pm 0.5\text{ V}$			85		dB
kSVR	Supply-voltage rejection ratio	$V_{CC\pm} = \pm 1.5\text{ V to } \pm 2.5\text{ V}$			80		dB

TLV2362Y operating characteristics, $V_{CC\pm} = \pm 2.5\text{ V}$, $T_A = 25^\circ\text{C}$

PARAMETER		TEST CONDITIONS			TLV2362Y			UNIT
					MIN	TYP	MAX	
SR	Slew rate	$A_V = 1$,	$V_I = \pm 0.5\text{ V}$			3		V/ μs
B_1	Unity-gain bandwidth	$A_V = 40$,	$R_L = 10\text{ k}\Omega$,	$C_L = 100\text{ pF}$		7		MHz
V_n	Equivalent input noise voltage	$R_S = 100\ \Omega$,	$R_F = 10\text{ k}\Omega$,	$f = 1\text{ kHz}$		8		nV/ $\sqrt{\text{Hz}}$

TLV2361, TLV2361Y, TLV2362, TLV2362Y HIGH-PERFORMANCE LOW-VOLTAGE OPERATIONAL AMPLIFIERS

SLOS195B – FEBRUARY 1997 – REVISED OCTOBER 1998

TYPICAL CHARACTERISTICS

Table of Graphs

GRAPH TITLE	FIGURE
Supply current vs Free-air temperature	1
Supply current vs Supply voltage	2
Maximum positive output voltage vs Output current	3
Maximum negative output voltage vs Output current	4
Maximum peak-to-peak output voltage vs Frequency	5
Equivalent input noise voltage vs Frequency	6
Total harmonic distortion vs Frequency	7
Total harmonic distortion vs Output voltage	8

TLV2361, TLV2361Y, TLV2362, TLV2362Y HIGH-PERFORMANCE LOW-VOLTAGE OPERATIONAL AMPLIFIERS

SLOS195B – FEBRUARY 1997 – REVISED OCTOBER 1998

TYPICAL CHARACTERISTICS

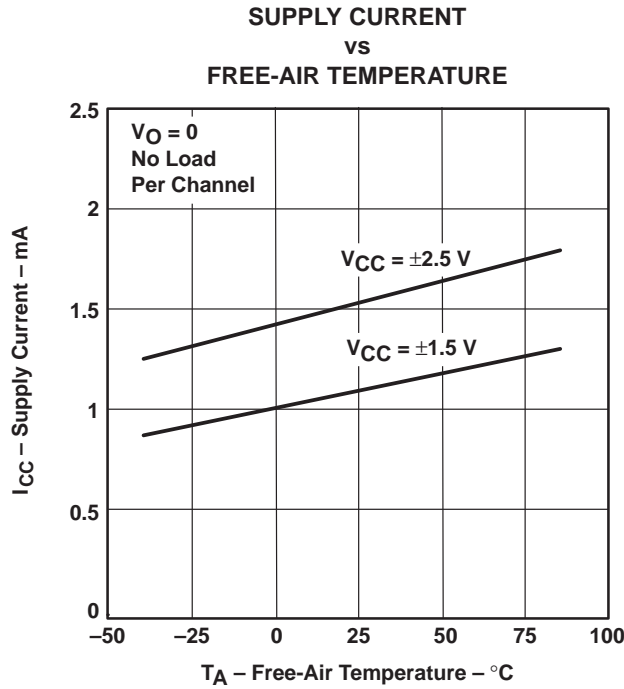

Figure 1

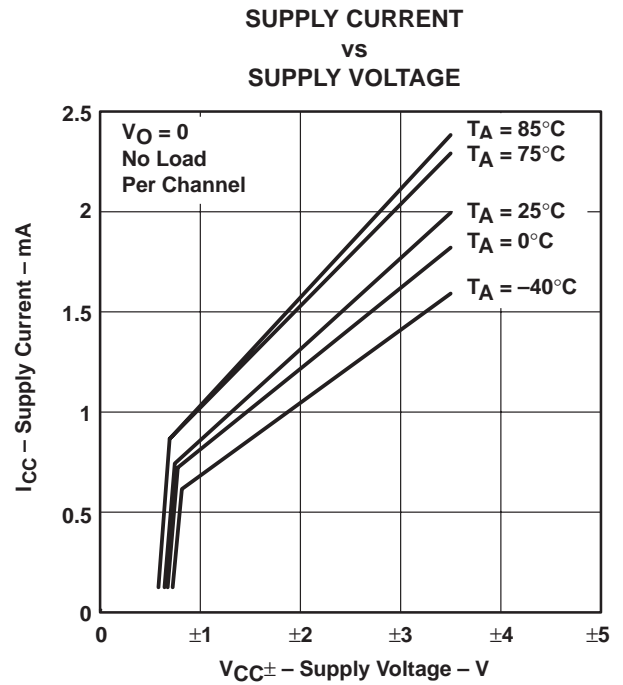

Figure 2

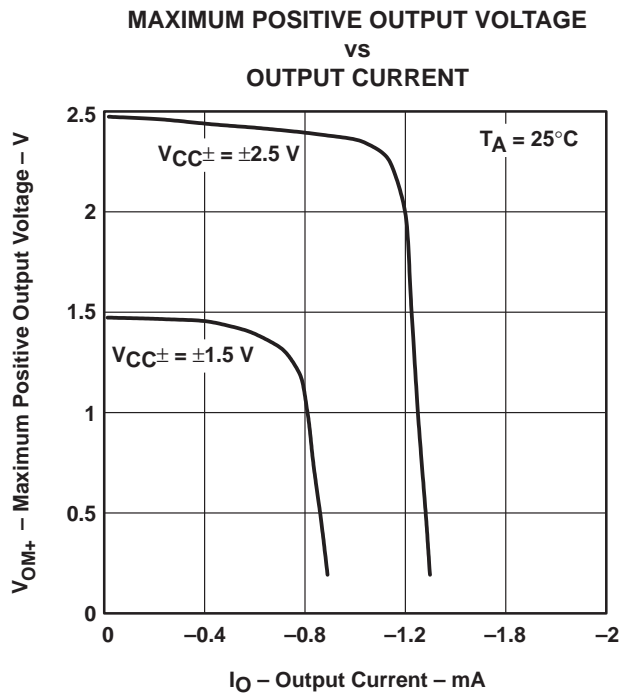

Figure 3

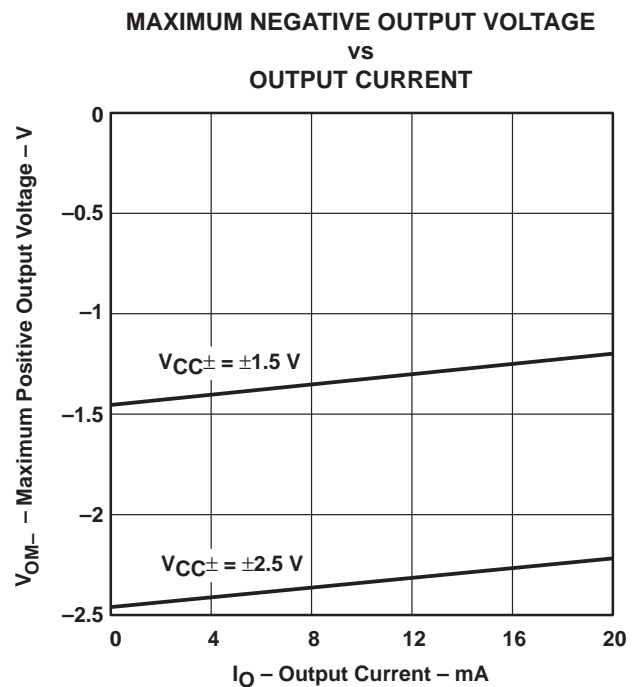

Figure 4

TLV2361, TLV2361Y, TLV2362, TLV2362Y HIGH-PERFORMANCE LOW-VOLTAGE OPERATIONAL AMPLIFIERS

SLOS195B – FEBRUARY 1997 – REVISED OCTOBER 1998

TYPICAL CHARACTERISTICS

MAXIMUM PEAK-TO-PEAK OUTPUT VOLTAGE
VS
FREQUENCY

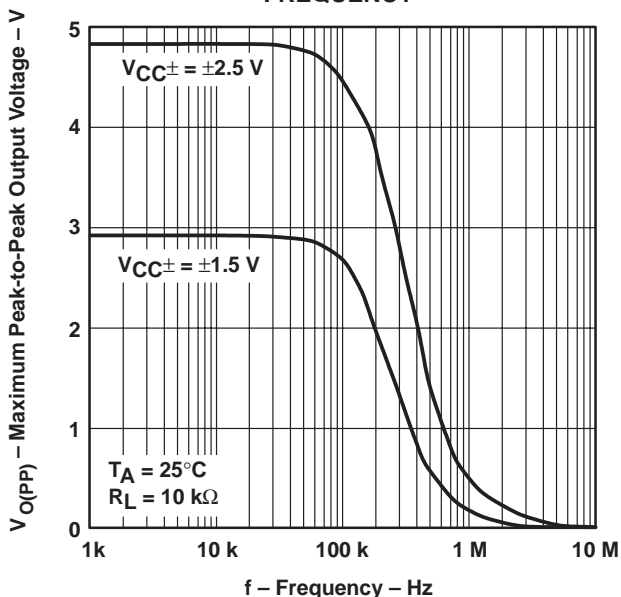

Figure 5

EQUIVALENT INPUT NOISE VOLTAGE
VS
FREQUENCY

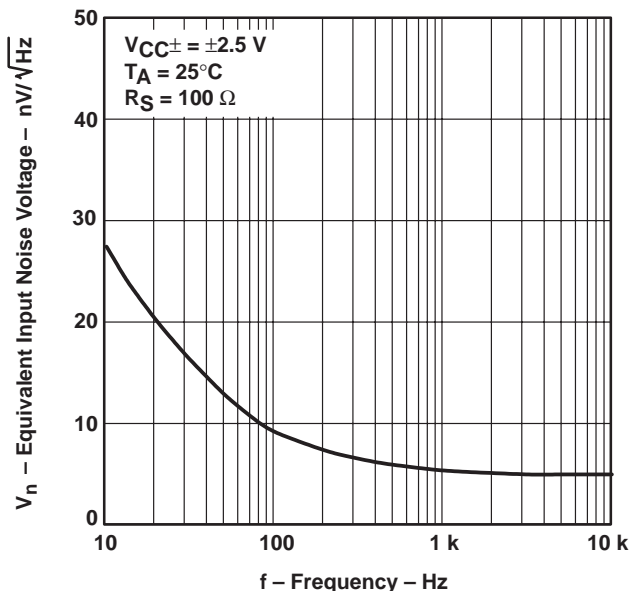

Figure 6

TOTAL HARMONIC DISTORTION
VS
FREQUENCY

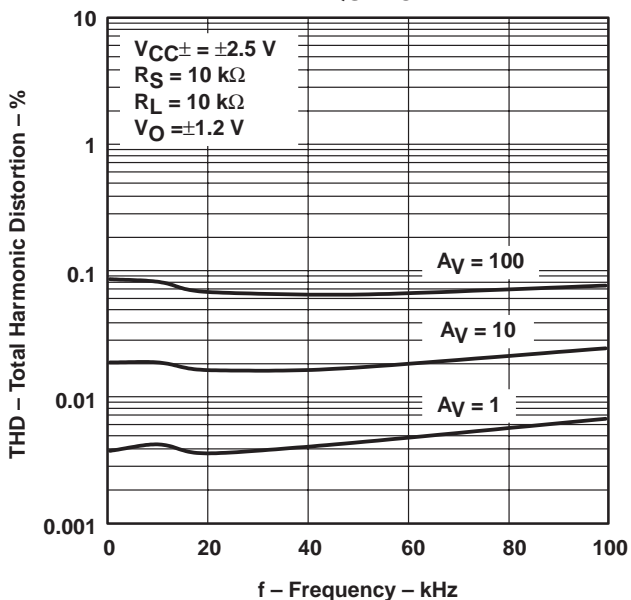

Figure 7

TOTAL HARMONIC DISTORTION
VS
OUTPUT VOLTAGE

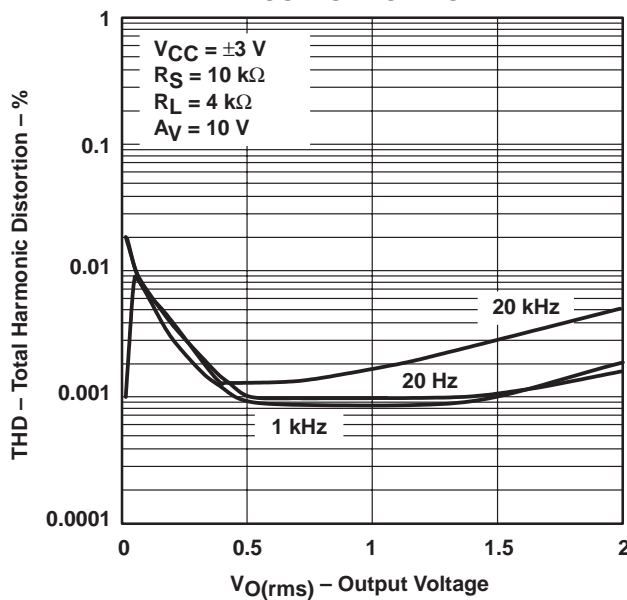

Figure 8

IMPORTANT NOTICE

Texas Instruments and its subsidiaries (TI) reserve the right to make changes to their products or to discontinue any product or service without notice, and advise customers to obtain the latest version of relevant information to verify, before placing orders, that information being relied on is current and complete. All products are sold subject to the terms and conditions of sale supplied at the time of order acknowledgement, including those pertaining to warranty, patent infringement, and limitation of liability.

TI warrants performance of its semiconductor products to the specifications applicable at the time of sale in accordance with TI's standard warranty. Testing and other quality control techniques are utilized to the extent TI deems necessary to support this warranty. Specific testing of all parameters of each device is not necessarily performed, except those mandated by government requirements.

CERTAIN APPLICATIONS USING SEMICONDUCTOR PRODUCTS MAY INVOLVE POTENTIAL RISKS OF DEATH, PERSONAL INJURY, OR SEVERE PROPERTY OR ENVIRONMENTAL DAMAGE ("CRITICAL APPLICATIONS"). TI SEMICONDUCTOR PRODUCTS ARE NOT DESIGNED, AUTHORIZED, OR WARRANTED TO BE SUITABLE FOR USE IN LIFE-SUPPORT DEVICES OR SYSTEMS OR OTHER CRITICAL APPLICATIONS. INCLUSION OF TI PRODUCTS IN SUCH APPLICATIONS IS UNDERSTOOD TO BE FULLY AT THE CUSTOMER'S RISK.

In order to minimize risks associated with the customer's applications, adequate design and operating safeguards must be provided by the customer to minimize inherent or procedural hazards.

TI assumes no liability for applications assistance or customer product design. TI does not warrant or represent that any license, either express or implied, is granted under any patent right, copyright, mask work right, or other intellectual property right of TI covering or relating to any combination, machine, or process in which such semiconductor products or services might be or are used. TI's publication of information regarding any third party's products or services does not constitute TI's approval, warranty or endorsement thereof.