



**TC4426
TC4427
TC4428**

1.5A DUAL HIGH-SPEED, POWER MOSFET DRIVERS

FEATURES

- High Peak Output Current 1.5A
- Wide Operating Range 4.5V to 18V
- High Capacitive Load Drive Capability 1000 pF in 25 nsec
- Short Delay Time <40nsec Typ
- Consistent Delay Times With Changes in Supply Voltage
- Low Supply Current
 - With Logic “1” Input 4mA
 - With Logic “0” Input 400µA
- Low Output Impedance 7Ω
- Latch-Up Protected: Will Withstand >0.5A Reverse Current Down to - 5V
- Input Will Withstand Negative Inputs
- ESD Protected 4kV
- Pinout Same as TC426/TC427/TC428

ORDERING INFORMATION

Part No.	Package	Temperature Range
TC4426COA	8-Pin SOIC	0°C to +70°C
TC4426CPA	8-Pin Plastic DIP	0°C to +70°C
TC4426EOA	8-Pin SOIC	- 40°C to +85°C
TC4426EPA	8-Pin Plastic DIP	- 40°C to +85°C
TC4426MJA	8-Pin CerDIP	- 55°C to +125°C
TC4427COA	8-Pin SOIC	0°C to +70°C
TC4427CPA	8-Pin Plastic DIP	0°C to +70°C
TC4427EOA	8-Pin SOIC	- 40°C to +85°C
TC4427EPA	8-Pin Plastic DIP	- 40°C to +85°C
TC4427MJA	8-Pin CerDIP	- 55°C to +125°C
TC4428COA	8-Pin SOIC	0°C to +70°C
TC4428CPA	8-Pin Plastic DIP	0°C to +70°C
TC4428EOA	8-Pin SOIC	- 40°C to +85°C
TC4428EPA	8-Pin Plastic DIP	- 40°C to +85°C
TC4428MJA	8-Pin CerDIP	- 55°C to +125°C

GENERAL DESCRIPTION

The TC4426/4427/4428 are improved versions of the earlier TC426/427/428 family of buffer/drivers (with which they are pin compatible). They will not latch up under any conditions within their power and voltage ratings. They are not subject to damage when up to 5V of noise spiking (of either polarity) occurs on the ground pin. They can accept, without damage or logic upset, up to 500mA of reverse current (of either polarity) being forced back into their outputs. All terminals are fully protected against up to 4kV of electrostatic discharge.

As MOSFET drivers, the TC4426/4427/4428 can easily switch 1000 pF gate capacitances in under 30nsec, and provide low enough impedances in both the ON and OFF states to ensure the MOSFET's intended state will not be affected, even by large transients.

Other compatible drivers are the TC4426A/27A/28A. These drivers have matched input to output leading edge and falling edge delays, tD1 and tD2, for processing short duration pulses in the 25 nanoseconds range. They are pin compatible with the TC4426/27/28.

FUNCTIONAL BLOCK DIAGRAM

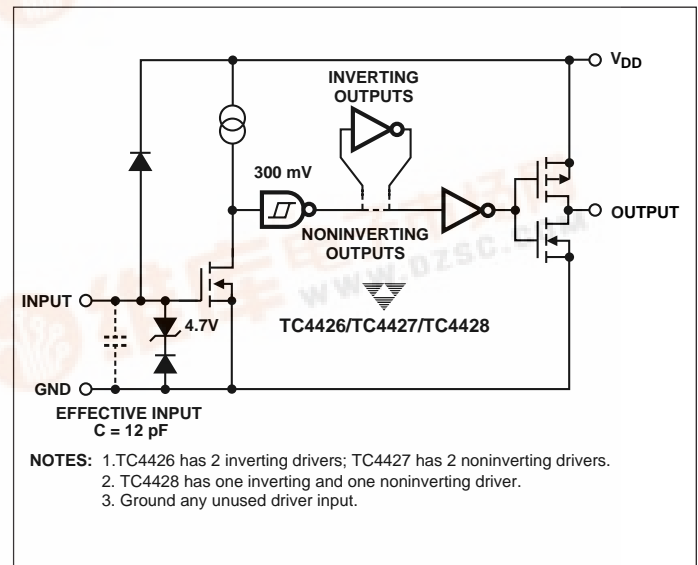

1.5A DUAL HIGH-SPEED POWER MOSFET DRIVERS

TC4426
TC4427
TC4428

ABSOLUTE MAXIMUM RATINGS*

Supply Voltage	+22V
Input Voltage, IN A or IN B. ($V_{DD} + 0.3V$) to (GND - 5.0V)	
Maximum Chip Temperature	+150°C
Storage Temperature Range	- 65°C to +150°C
Lead Temperature (Soldering, 10 sec)	+300°C
Package Thermal Resistance	
CerDIP $R_{\theta J-A}$	150°C/W
CerDIP $R_{\theta J-C}$	50°C/W
PDIP $R_{\theta J-A}$	125°C/W
PDIP $R_{\theta J-C}$	42°C/W
SOIC $R_{\theta J-A}$	155°C/W
SOIC $R_{\theta J-C}$	45°C/W

Operating Temperature Range

C Version	0°C to +70°C
E Version	- 40°C to +85°C
M Version	- 55°C to +125°C
Package Power Dissipation ($T_A \leq 70^\circ C$)	
Plastic	730mW
CerDIP	800mW
SOIC	470mW

*Static-sensitive device. Unused devices must be stored in conductive material. Protect devices from static discharge and static fields. Stresses above those listed under "Absolute Maximum Ratings" may cause permanent damage to the device. These are stress ratings only and functional operation of the device at these or any other conditions above those indicated in the operation sections of the specifications is not implied. Exposure to absolute maximum rating conditions for extended periods may affect device reliability.

PIN CONFIGURATIONS

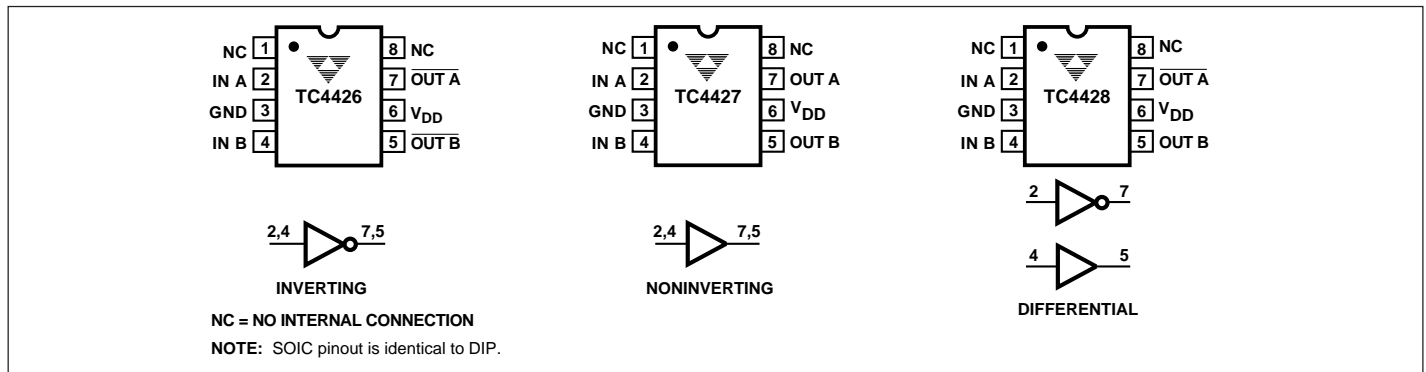

ELECTRICAL CHARACTERISTICS: $T_A = +25^\circ C$ with $4.5V \leq V_{DD} \leq 18V$, unless otherwise specified.

Symbol	Parameter	Test Conditions	Min	Typ	Max	Unit
Input						
V_{IH}	Logic 1 High Input Voltage		2.4	—	—	V
V_{IL}	Logic 0 Low Input Voltage		—	—	0.8	V
I_{IN}	Input Current	$0V \leq V_{IN} \leq V_{DD}$	- 1	—	1	μA
Output						
V_{OH}	High Output Voltage		$V_{DD} - 0.025$	—	—	V
V_{OL}	Low Output Voltage		—	—	0.025	V
R_O	Output Resistance	$V_{DD} = 18V, I_O = 10\text{ mA}$	—	7	10	Ω
I_{PK}	Peak Output Current	Duty Cycle $\leq 2\%$, $t \leq 30\ \mu\text{sec}$	—	1.5	—	A
I_{REV}	Latch-Up Protection Withstand Reverse Current	Duty Cycle $\leq 2\%$, $t \leq 30\ \mu\text{sec}$	> 0.5	—	—	A
Switching Time (Note 1)						
t_R	Rise Time	Figure 1	—	19	30	nsec
t_F	Fall Time	Figure 1	—	19	30	nsec
t_{D1}	Delay Time	Figure 1	—	20	30	nsec
t_{D2}	Delay Time	Figure 1	—	40	50	nsec
Power Supply						
I_S	Power Supply Current	$V_{IN} = 3V$ (Both Inputs) $V_{IN} = 0V$ (Both Inputs)	—	—	4.5	mA
			—	—	0.4	mA

NOTE: 1. Switching times are measured at $V_{DD} = 18V$.

1.5A DUAL HIGH-SPEED POWER MOSFET DRIVERS

TC4426
TC4427
TC4428

ELECTRICAL CHARACTERISTICS (CONT.): Specifications measured over operating temperature range with $4.5V \leq V_{DD} \leq 18V$, unless otherwise specified.

Symbol	Parameter	Test Conditions	Min	Typ	Max	Unit
Input						
V_{IH}	Logic 1 High Input Voltage		2.4	—	—	V
V_{IL}	Logic 0 Low Input Voltage		—	—	0.8	V
I_{IN}	Input Current	$0V \leq V_{IN} \leq V_{DD}$	-10	—	10	μA
Output						
V_{OH}	High Output Voltage		$V_{DD} - 0.025$	—	—	V
V_{OL}	Low Output Voltage		—	—	0.025	V
R_O	Output Resistance	$V_{DD} = 18V, I_O = 10\text{ mA}$	—	9	12	Ω
I_{PK}	Peak Output Current	Duty Cycle $\leq 2\%$, $t \leq 300\mu\text{sec}$	—	1.5	—	A
I_{REV}	Latch-Up Protection Withstand Reverse Current	Duty Cycle $\leq 2\%$, $t \leq 300\mu\text{sec}$	> 0.5	—	—	A
Switching Time (Note 1)						
t_R	Rise Time	Figure 1	—	—	40	nsec
t_F	Fall Time	Figure 1	—	—	40	nsec
t_{D1}	Delay Time	Figure 1	—	—	40	nsec
t_{D2}	Delay Time	Figure 1	—	—	60	nsec
Power Supply						
I_S	Power Supply Current	$V_{IN} = 3V$ (Both Inputs) $V_{IN} = 0V$ (Both Inputs)	—	—	8	mA

NOTE: 1. Switching times are guaranteed by design.

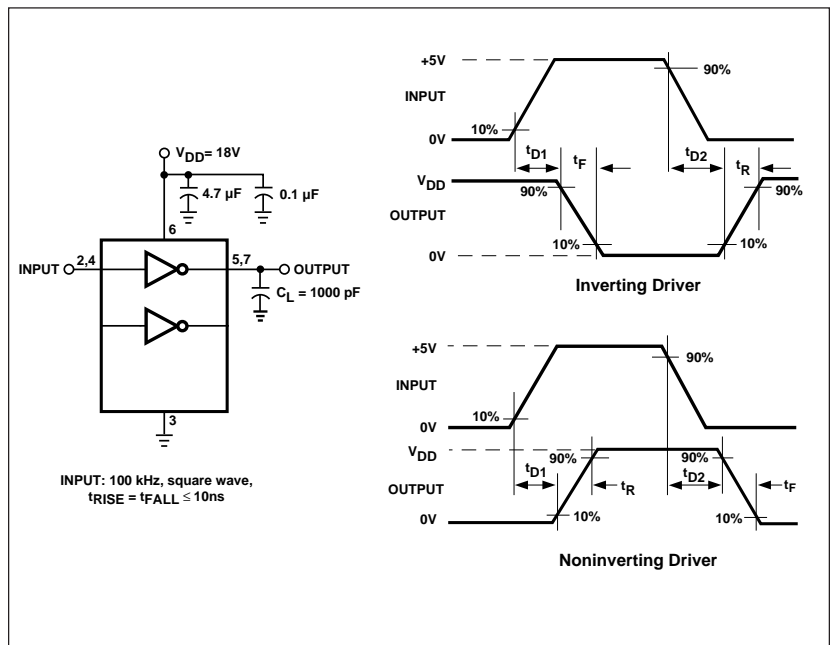
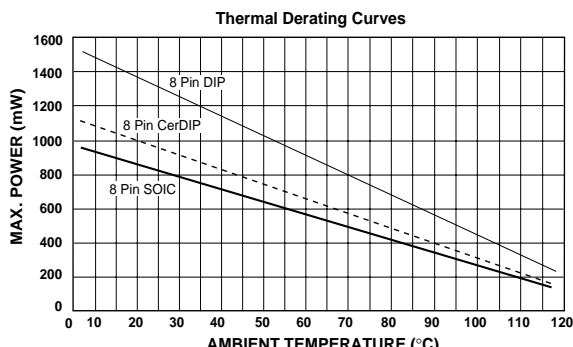
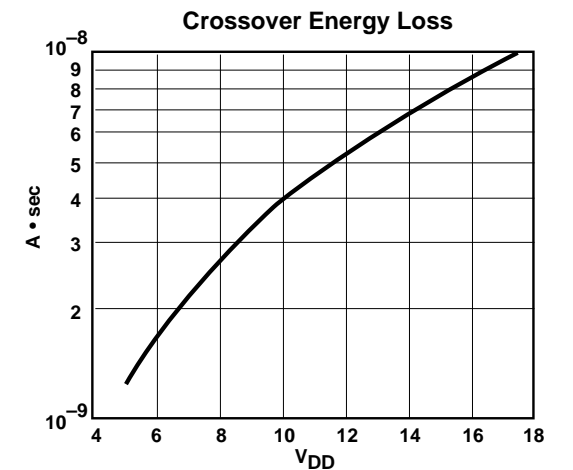

Figure 1. Switching Time Test Circuit

NOTE: The values on this graph represent the loss seen by both drivers in a package during one complete cycle. For a single driver, divide the stated values by 2. For a single transition of a single driver, divide the stated value by 4.

1.5A DUAL HIGH-SPEED POWER MOSFET DRIVERS

TC4426
TC4427
TC4428

TYPICAL CHARACTERISTICS

Rise Time vs. Supply Voltage

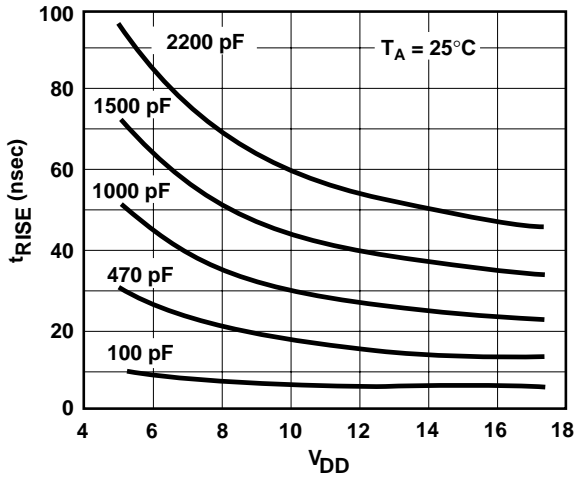

Fall Time vs. Supply Voltage

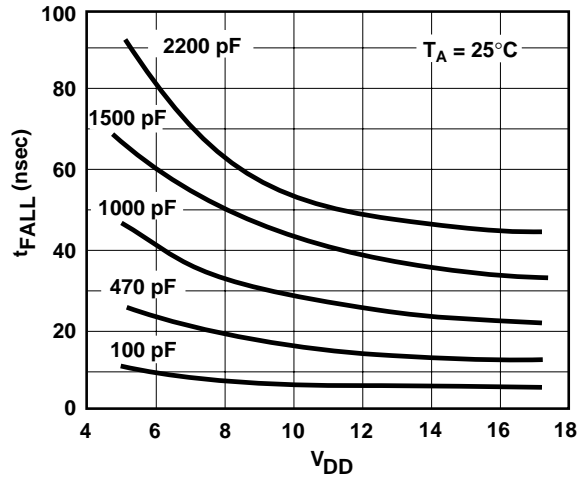

Rise Time vs. Capacitive Load

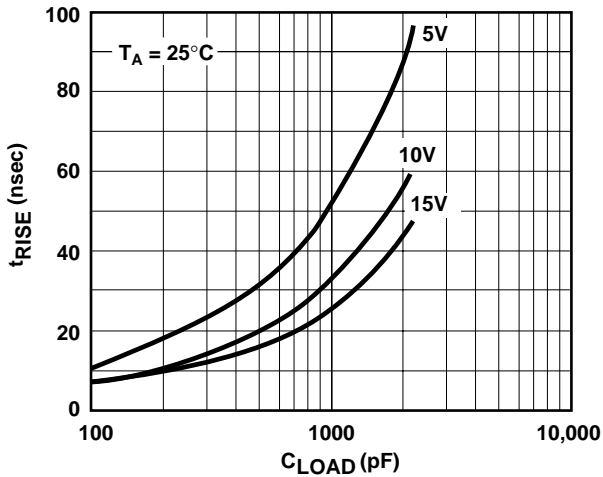

Fall Time vs. Capacitive Load

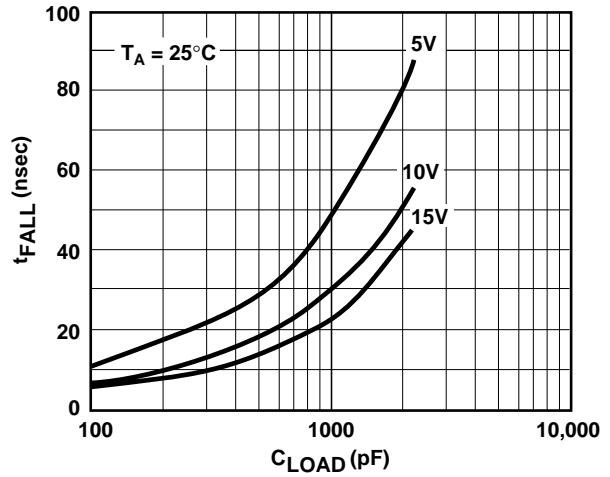

Rise and Fall Times vs. Temperature

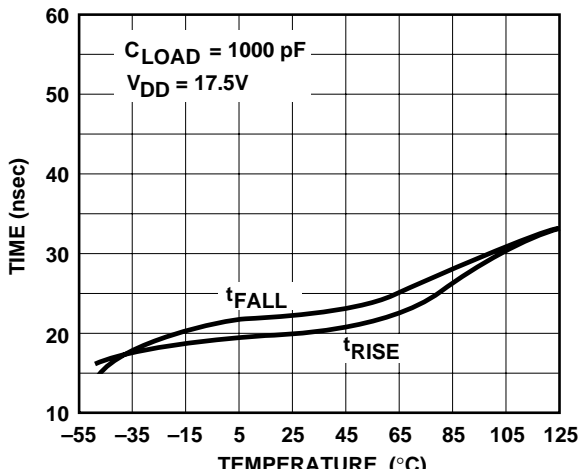

Propagation Delay vs. Supply Voltage

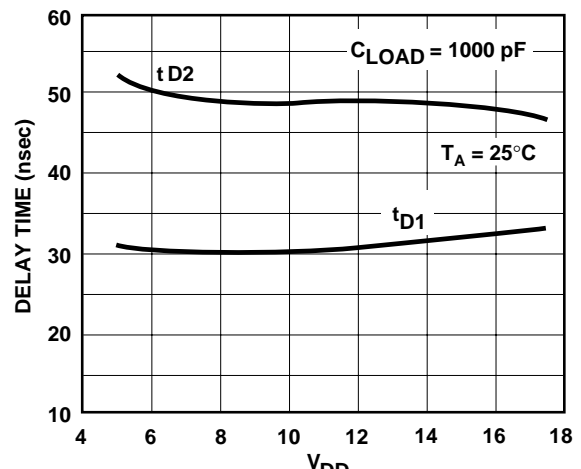

1.5A DUAL HIGH-SPEED POWER MOSFET DRIVERS

TC4426
TC4427
TC4428

TYPICAL CHARACTERISTICS (Cont.)

Effect of Input Amplitude on Delay Time

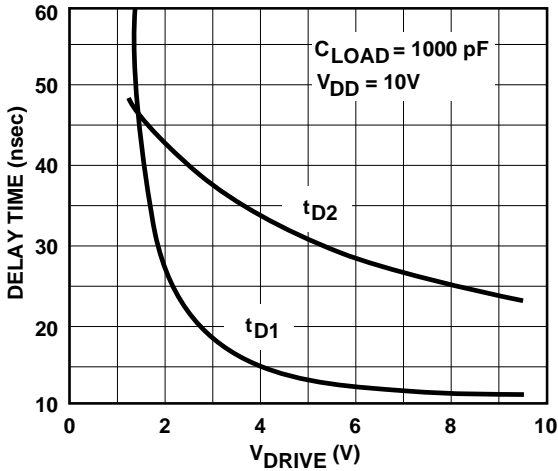

Propagation Delay Time vs. Temperature

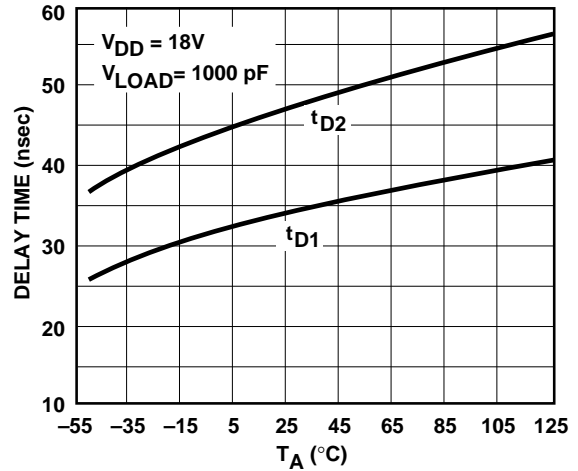

Quiescent Supply Current vs. Voltage

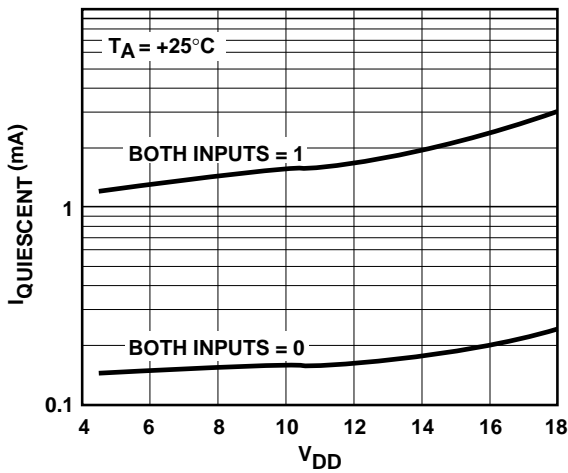

Quiescent Supply Current vs. Temperature

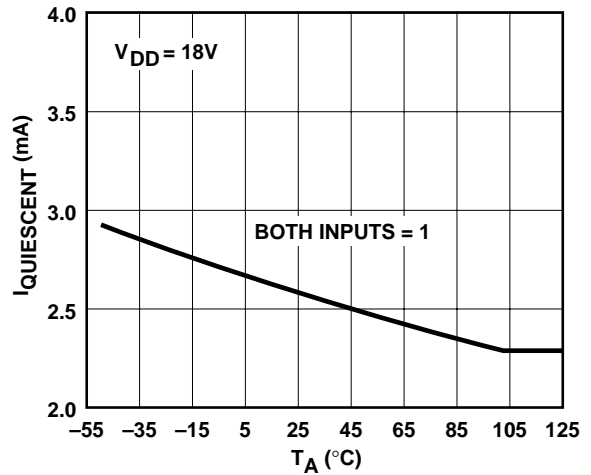

High-State Output Resistance

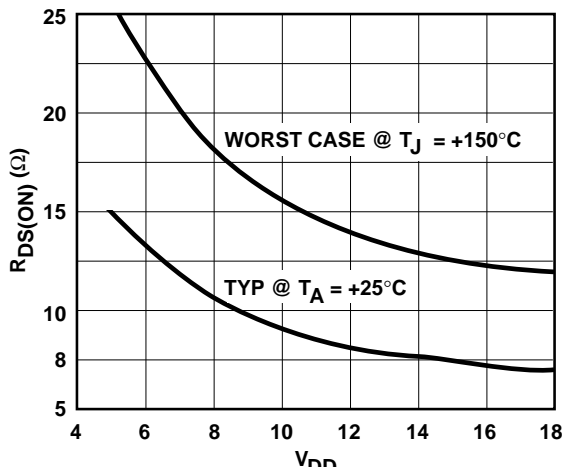

Low-State Output Resistance

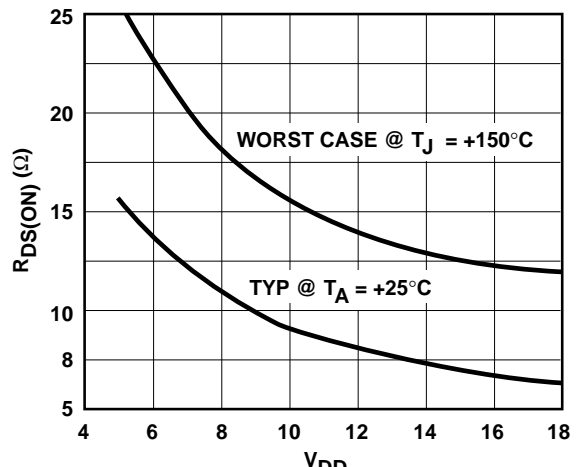

1.5A DUAL HIGH-SPEED POWER MOSFET DRIVERS

TC4426
TC4427
TC4428

SUPPLY CURRENT CHARACTERISTICS (Load on Single Output Only)

