

EVALUATION KIT
AVAILABLE

MAXIM

High-Speed, Low-Distortion, Differential Line Receivers

General Description

The MAX4144/MAX4145/MAX4146 differential line receivers offer unparalleled high-speed, low-distortion performance. Using a three op-amp instrumentation amplifier architecture, these ICs have fully symmetrical differential inputs and a single-ended output. They operate from $\pm 5V$ power supplies and are capable of driving a 150Ω load to $\pm 3.7V$. The MAX4144 has an internally set closed-loop gain of $+2V/V$. The MAX4145 is optimized for gains from $+1V/V$ to $+10V/V$, while the MAX4146 is optimized for gains from $+10V/V$ to $+100V/V$. The MAX4145/MAX4146 require a single external resistor to set the closed-loop gain.

These amplifiers use laser-trimmed, matched thin-film resistors to deliver a common-mode rejection (CMR) of up to 90dB at 10MHz. Using current-feedback techniques, the MAX4144 achieves a 130MHz bandwidth and a $1000V/\mu s$ slew rate. The MAX4145 achieves a bandwidth of 180MHz and a slew rate of $600V/\mu s$ while operating with a closed-loop gain of $+1V/V$, and the MAX4146 features a bandwidth of 70MHz and a slew rate of $800V/\mu s$ with a gain of $+10V/V$. Excellent differential gain/phase and noise specifications make these amplifiers ideal for a wide variety of video and RF signal-processing applications.

For a complete differential transmission link, use the MAX4144/MAX4145/MAX4146 with the MAX4147 differential line driver (see the MAX4147 data sheet for more information).

Applications

Differential to Single-Ended Conversion
Twisted-Pair to Coaxial Converter
High-Speed Instrumentation Amplifier
Data Acquisition
Medical Instrumentation
High-Speed Differential Line Receiver

Pin Configurations appear at end of data sheet.

Typical Application Circuit appears at end of data sheet.

Features

MAX4144:

- ◆ $+2V/V$ Internally Fixed Gain
- ◆ 130MHz Bandwidth
- ◆ $1000V/\mu s$ Slew Rate
- ◆ 70dB CMR at 10MHz
- ◆ -90dBc SFDR ($f = 10kHz$)
- ◆ Low Differential Gain/Phase: 0.03%/0.03°
- ◆ 800 μA Shutdown

MAX4145:

- ◆ External Gain Selection from $+1V/V$ to $+10V/V$
- ◆ 180MHz Bandwidth
- ◆ 90MHz 0.1dB Gain Flatness
- ◆ $600V/\mu s$ Slew Rate
- ◆ 75dB CMR at 10MHz
- ◆ -92dBc SFDR ($f = 10kHz$)
- ◆ Very Low Noise: $3.8nV/\sqrt{Hz}$ ($G = +10V/V$)
- ◆ 800 μA Shutdown

MAX4146:

- ◆ External Gain Selection from $+10V/V$ to $+100V/V$
- ◆ 70MHz Bandwidth ($A_V = +10V/V$)
- ◆ $800V/\mu s$ Slew Rate
- ◆ 90dB CMR at 10MHz
- ◆ -82dBc SFDR ($f = 10kHz$)
- ◆ Very Low Noise: $3.45nV/\sqrt{Hz}$ ($G = +100V/V$)
- ◆ 800 μA Shutdown

Ordering Information

PART	TEMP. RANGE	PIN-PACKAGE
MAX4144ESD	-40°C to +85°C	14 SO
MAX4144EEE	-40°C to +85°C	16 QSOP
MAX4145ESD	-40°C to +85°C	14 SO
MAX4145EEE	-40°C to +85°C	16 QSOP
MAX4146ESD	-40°C to +85°C	14 SO
MAX4146EEE	-40°C to +85°C	16 QSOP

MAX4144/MAX4145/MAX4146



High-Speed, Low-Distortion, Differential Line Receivers

ABSOLUTE MAXIMUM RATINGS

Supply Voltage (V_{CC} to V_{EE})12V
 Voltage on IN_{-} , SHDN, REF, OUT,
 SENSE, RG_{-} ($V_{EE} - 0.3V$) to ($V_{CC} + 0.3V$)
 Short-Circuit Duration to Ground10sec
 Input Current (IN_{-} , RG_{-}) $\pm 10mA$
 Output Current $\pm 120mA$

Continuous Power Dissipation ($T_A = +70^{\circ}C$)
 14-Pin SO (derate 8.33mW/ $^{\circ}C$ above $+70^{\circ}C$)667mW
 16-Pin QSOP (derate 8.33mW/ $^{\circ}C$ above $+70^{\circ}C$)667mW
 Operating Temperature Range $-40^{\circ}C$ to $+85^{\circ}C$
 Storage Temperature Range $-65^{\circ}C$ to $+150^{\circ}C$
 Lead Temperature (soldering, 10sec) $+300^{\circ}C$

Stresses beyond those listed under "Absolute Maximum Ratings" may cause permanent damage to the device. These are stress ratings only, and functional operation of the device at these or any other conditions beyond those indicated in the operational sections of the specifications is not implied. Exposure to absolute maximum rating conditions for extended periods may affect device reliability.

DC ELECTRICAL CHARACTERISTICS

($V_{CC} = +5V$, $V_{EE} = -5V$, SHDN = 0V, $R_L = \infty$, $T_A = T_{MIN}$ to T_{MAX} , unless otherwise noted. Typical values are at $T_A = +25^{\circ}C$.)

PARAMETER	SYMBOL	CONDITIONS		MIN	TYP	MAX	UNITS
Operating Supply Voltage		Guaranteed by PSR test		± 4.5		± 5.5	V
Input Offset Voltage	V_{OS}	$V_{IN} = 0V$			0.6	8	mV
Input Offset Voltage Drift	TC_{VOS}	$V_{IN} = 0V$			5		$\mu V/^{\circ}C$
Input Bias Current	I_B	$V_{IN} = 0V$			9	20	μA
Input Offset Current	I_{OS}	$V_{IN} = 0V$			0.1	2.5	μA
Input Capacitance	C_{IN}				1		pF
Differential Input Resistance	R_{IN}				1		$M\Omega$
Differential Input Voltage Range		$R_L = 150\Omega$	MAX4144	-1.55		1.55	V
			MAX4145	-2.8/G		2.8/G	
			MAX4146	-3.1/G		3.1/G	
Common-Mode Input Voltage Range	V_{CM}	Guaranteed by CMR test		-2.8		2.8	V
Gain	A_V	$-1V \leq V_{OUT} \leq +1V$, $R_L = 150\Omega$	MAX4144	2			V/V
			MAX4145	$1 + (1.4k\Omega/R_G)$			
			MAX4146	$10 + (14k\Omega/R_G)$			
Gain Error		$-1V \leq V_{OUT} \leq +1V$, $R_L = 150\Omega$	MAX4144	$A_V = 2V/V$	0.02	2	%
			MAX4145	$A_V = 1V/V$	0.5	2	
				$A_V = 10V/V$	1.5	5	
			MAX4146	$A_V = 10V/V$	0.5	2	
Gain Drift		$-1V \leq V_{OUT} \leq +1V$, $R_L = 150\Omega$	MAX4144	20			ppm/ $^{\circ}C$
			MAX4145	$5 + 15G$			
			MAX4146	$14 + 0.9G$			
Common-Mode Rejection	CMR	$V_{CM} = \pm 2.8V$		60	80		dB
Power-Supply Rejection	PSR	$V_S = \pm 4.5V$ to $\pm 5.5V$		70	85		dB
Quiescent Supply Current					11	16	mA
Shutdown Supply Current	I_{SHDN}	$V_{SHDN} \geq 2V$			0.8	2	mA
Shutdown Output Impedance		$V_{SHDN} \geq 2V$	MAX4144	1.4			k Ω
			MAX4145	1.4			
			MAX4146	2			
Output Voltage Swing	V_{OUT}	$R_L = 100\Omega$			± 3.6		V
		$R_L = 150\Omega$	± 3.1	± 3.7			
		$R_L = \infty$	± 3.4	± 3.8			

High-Speed, Low-Distortion, Differential Line Receivers

MAX4144/MAX4145/MAX4146

DC ELECTRICAL CHARACTERISTICS (continued)

($V_{CC} = +5V$, $V_{EE} = -5V$, $SHDN = 0V$, $R_L = \infty$, $T_A = T_{MIN}$ to T_{MAX} , unless otherwise noted. Typical values are at $T_A = +25^\circ C$.)

PARAMETER	SYMBOL	CONDITIONS		MIN	TYP	MAX	UNITS
Output Current Drive	I_{OUT}	$V_{OUT} = \pm 1.7V$	$0^\circ C \leq T_A \leq +85^\circ C$	80	100		mA
			$-40^\circ C \leq T_A \leq 0^\circ C$	60			
SHDN High Threshold	V_{IH}					2	V
SHDN Low Threshold	V_{IL}			0.8			V
SHDN Input Bias Current	I_{SHDN}	$V_{SHDN} \leq 0.8V$			75	150	μA
		$V_{SHDN} \geq 2V$			0.06	2	

AC ELECTRICAL CHARACTERISTICS

($V_{CC} = +5V$, $V_{EE} = -5V$, $SHDN = 0V$, $R_L = 150\Omega$, $T_A = T_{MIN}$ to T_{MAX} , unless otherwise noted. Typical values are at $T_A = +25^\circ C$.)

PARAMETER	SYMBOL	CONDITIONS		MIN	TYP	MAX	UNITS	
-3dB Bandwidth	$BW_{(-3dB)}$	$V_{OUT} \leq 0.1V_{RMS}$	MAX4144	$A_V = 2V/V$		130	MHz	
			MAX4145	$A_V = 1V/V$		180		
			MAX4146	$A_V = 10V/V$		70		
				$A_V = 100V/V$		30		
Full-Power Bandwidth	FPBW	$V_{OUT} = 2V_{p-p}$	MAX4144	$A_V = 2V/V$		110	MHz	
			MAX4145	$A_V = 1V/V$		180		
			MAX4146	$A_V = 10V/V$		70		
				$A_V = 100V/V$		30		
0.1dB Bandwidth	$BW_{(0.1dB)}$	$V_{OUT} \leq 0.1V_{RMS}$	MAX4144	$A_V = 2V/V$		30	MHz	
			MAX4145	$A_V = 1V/V$		90		
			MAX4146	$A_V = 10V/V$		50		
Input Voltage Noise Density	e_n	$f = 1MHz$	MAX4144			12	nV/\sqrt{Hz}	
			MAX4145			$1.8 + (20/G)$		
			MAX4146			$2.1 + (135/G)$		
Input Current Noise Density	i_n	$f = 1MHz$			1.7	pA/\sqrt{Hz}		
Common-Mode Rejection	CMR	$f = 10MHz$	MAX4144			70	dB	
			MAX4145			75		
			MAX4146			90		
Slew Rate	SR	$-2V \leq V_{OUT} \leq +2V$	MAX4144			1000	$V/\mu s$	
			MAX4145			600		
			MAX4146			800		
Settling Time to 0.1%	t_s	$-2V \leq V_{OUT} \leq +2V$	to 0.1%	MAX4144			23	ns
				MAX4145			20	
				MAX4146			17	
			to 0.01%	MAX4144			36	
				MAX4145			38	
				MAX4146			40	
Enable Time from Shutdown					45	ns		
Disable Time to Shutdown					40	μs		
Differential Gain (Note 1)	DG	$f = 3.58MHz$	MAX4144			0.03	%	
			MAX4145			0.01		
			MAX4146			0.12		

High-Speed, Low-Distortion, Differential Line Receivers

AC ELECTRICAL CHARACTERISTICS (continued)

(VCC = +5V, VEE = -5V, SHDN = 0V, RL = 150Ω, TA = TMIN to TMAX, unless otherwise noted. Typical values are at TA = +25°C.)

PARAMETER	SYMBOL	CONDITIONS		MIN	TYP	MAX	UNITS
Differential Phase (Note 1)	DP	f = 3.58MHz	MAX4144		0.03		Degrees
			MAX4145		0.06		
			MAX4146		0.07		
Spurious-Free Dynamic Range	SFDR	f = 10kHz, VOUT = 2Vp-p	MAX4144	AV = 2V/V	-90		dBc
			MAX4145	AV = 1V/V	-92		
			MAX4146	AV = 10V/V	-82		
		f = 5MHz, VOUT = 2Vp-p	MAX4144	AV = 2V/V	-66		
			MAX4145	AV = 1V/V	-67		
			MAX4146	AV = 10V/V	-48		

Note 1: Differential gain and phase are tested using a modulated ramp, 100 IRE (0.714V).

Typical Operating Characteristics

(VCC = +5V, VEE = -5V, SHDN = 0V, RL = 150Ω, TA = +25°C, unless otherwise noted.)

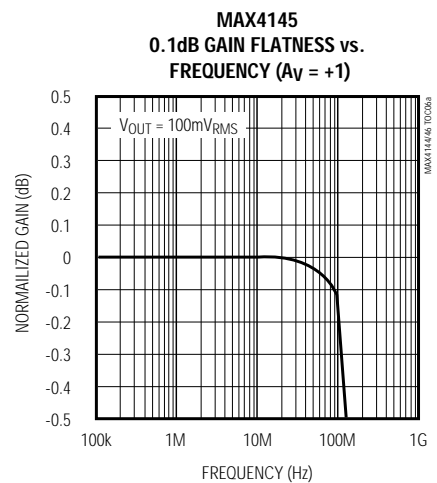
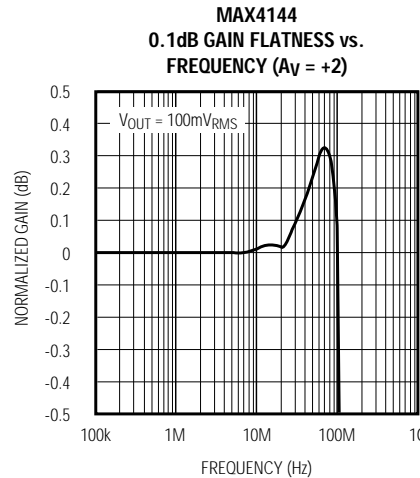
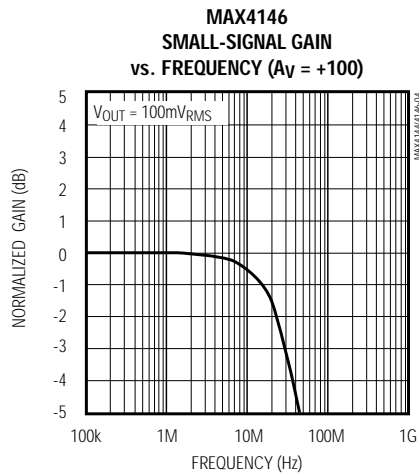
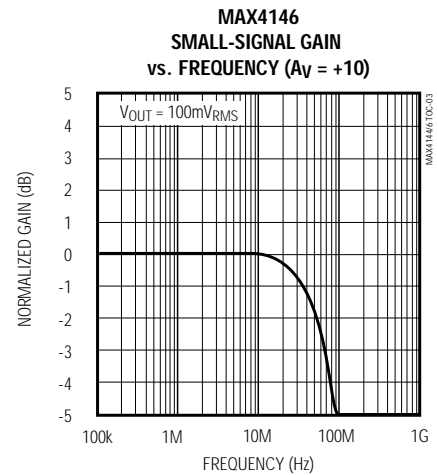
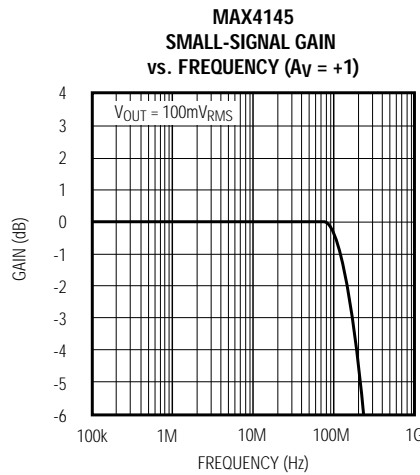
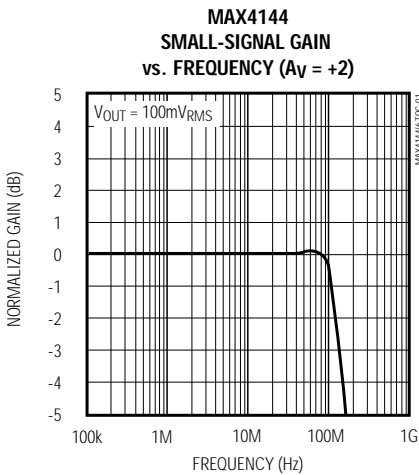

High-Speed, Low-Distortion, Differential Line Receivers

Typical Operating Characteristics (continued)

($V_{CC} = +5V$, $V_{EE} = -5V$, $SHDN = 0V$, $R_L = 150\Omega$, $T_A = +25^\circ C$, unless otherwise noted.)

MAX4144/MAX4145/MAX4146

MAX4146
0.1dB GAIN FLATNESS vs. FREQUENCY ($A_V = +10$)

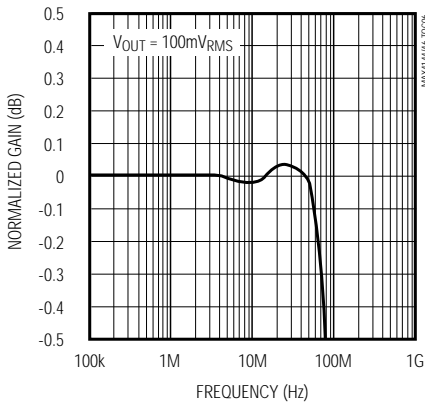

MAX4144
LARGE-SIGNAL GAIN vs. FREQUENCY ($A_V = +2$)

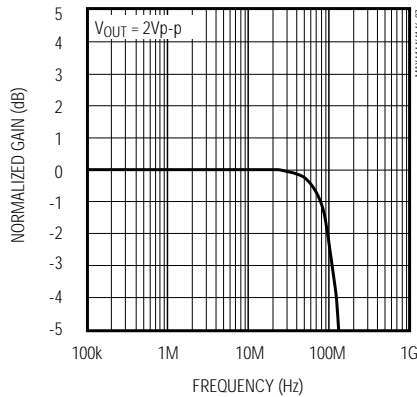

MAX4145
LARGE-SIGNAL GAIN vs. FREQUENCY ($A_V = +1$)

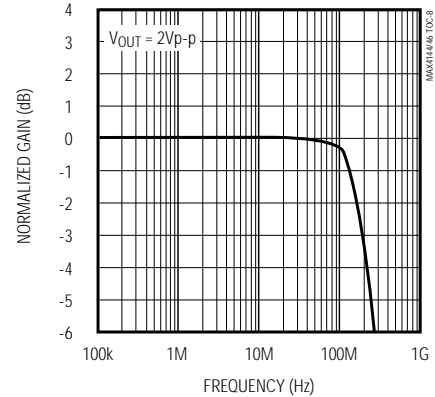

MAX4146
SMALL-SIGNAL GAIN vs. FREQUENCY ($A_V = +10$)

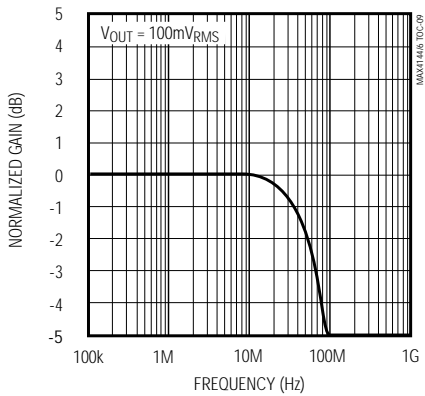

MAX4146
LARGE-SIGNAL GAIN vs. FREQUENCY ($A_V = +100$)

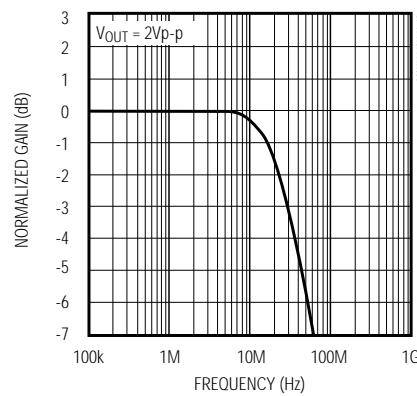

MAX4144
SMALL-SIGNAL PULSE RESPONSE ($A_V = +2$)

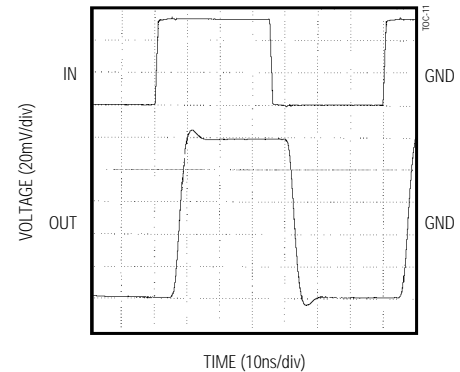

MAX4145
SMALL-SIGNAL PULSE RESPONSE ($A_V = +1$)

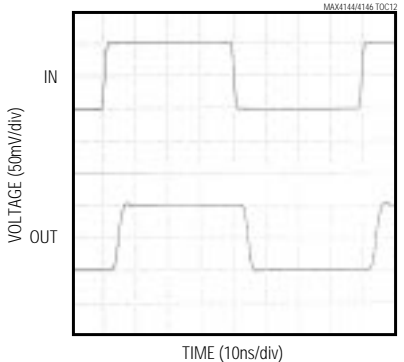

MAX4146
SMALL-SIGNAL PULSE RESPONSE ($A_V = +10$)

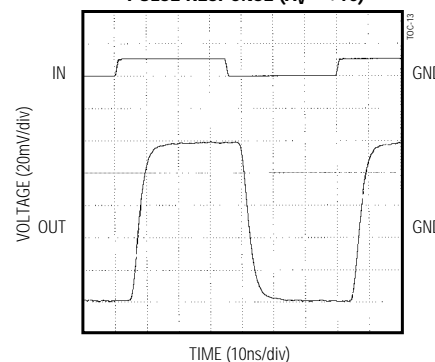

MAX4146
SMALL-SIGNAL PULSE RESPONSE ($A_V = +100$)

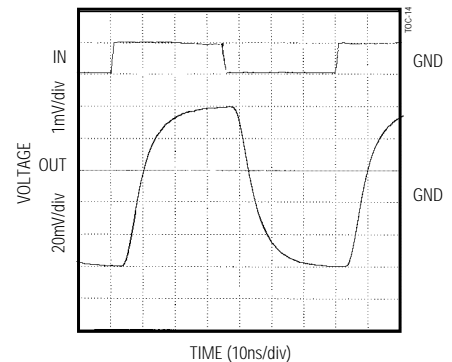

High-Speed, Low-Distortion, Differential Line Receivers

Typical Operating Characteristics (continued)

($V_{CC} = +5V$, $V_{EE} = -5V$, SHDN = 0V, $R_L = 150\Omega$, $T_A = +25^\circ C$, unless otherwise noted.)

**MAX4144
LARGE-SIGNAL
PULSE RESPONSE ($A_V = +2$)**

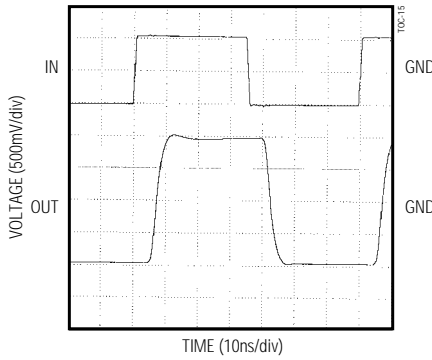

**MAX4145
LARGE-SIGNAL
PULSE RESPONSE ($A_V = +1$)**

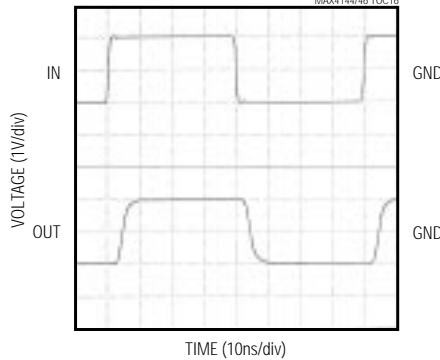

**MAX4146
LARGE-SIGNAL
PULSE RESPONSE ($A_V = +10$)**

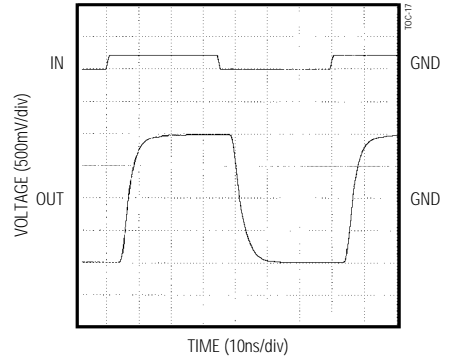

**MAX4146
LARGE-SIGNAL
PULSE RESPONSE ($A_V = +100$)**

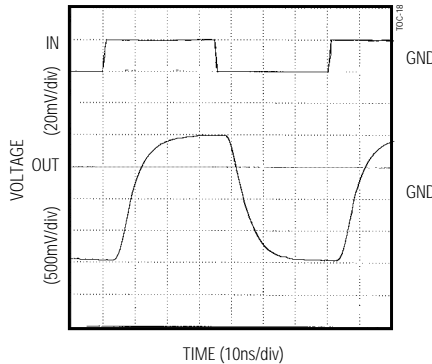

**CLOSED-LOOP OUTPUT IMPEDANCE
vs. FREQUENCY ($A_V = +1$)**

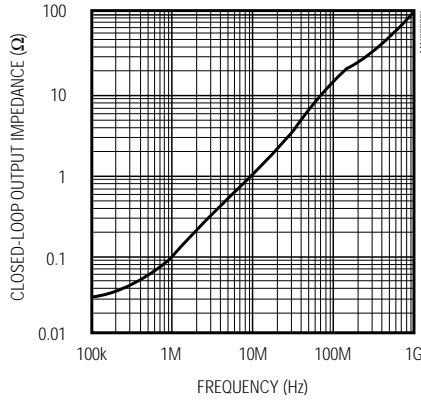

**MAX4144
DIFFERENTIAL GAIN AND PHASE**

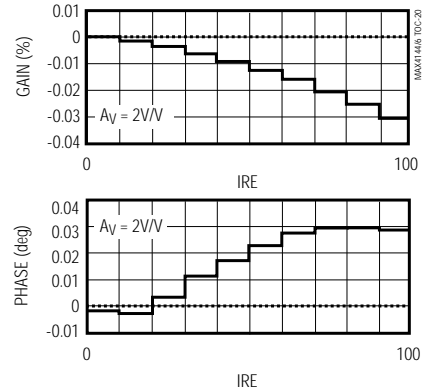

**MAX4145
DIFFERENTIAL GAIN AND PHASE**

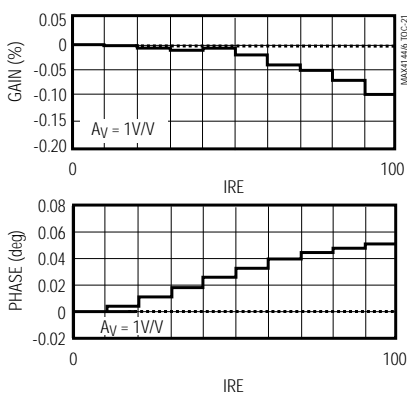

**MAX4146
DIFFERENTIAL GAIN AND PHASE**

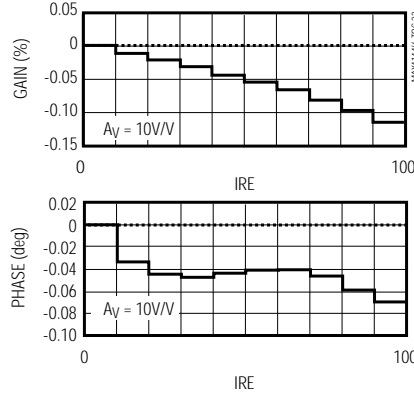

**OUTPUT SWING
vs. LOAD RESISTANCE**

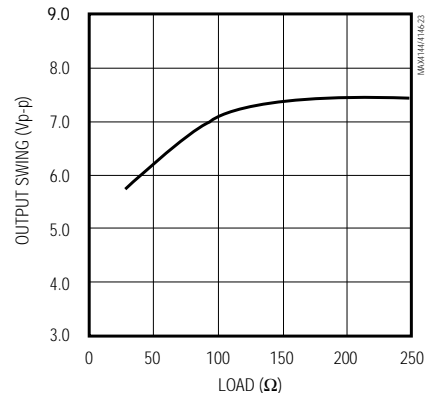

High-Speed, Low-Distortion, Differential Line Receivers

Typical Operating Characteristics (continued)

($V_{CC} = +5V$, $V_{EE} = -5V$, $SHDN = 0V$, $R_L = 150\Omega$, $T_A = +25^\circ C$, unless otherwise noted.)

MAX4144/MAX4145/MAX4146

MAX4144
HARMONIC DISTORTION
vs. FREQUENCY ($A_V = +2$)

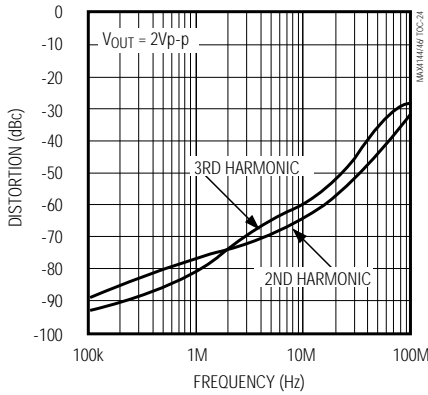

MAX4145
HARMONIC DISTORTION
vs. FREQUENCY ($A_V = +1$)

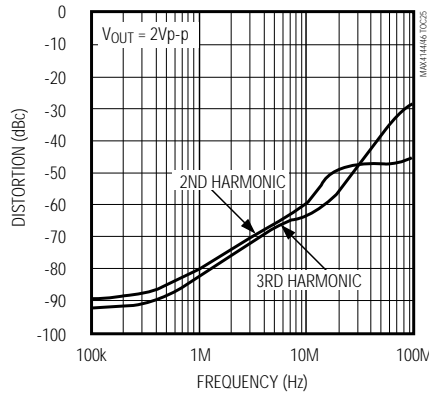

MAX4146
HARMONIC DISTORTION
vs. FREQUENCY ($A_V = +10$)

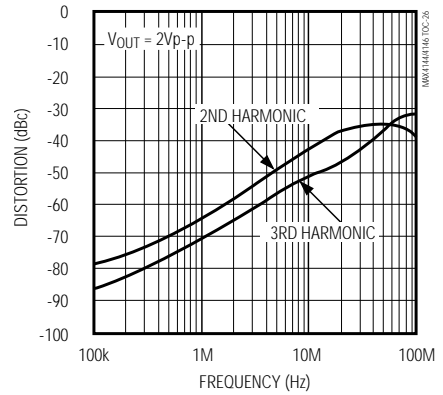

MAX4146
HARMONIC DISTORTION
vs. FREQUENCY ($A_V = +100$)

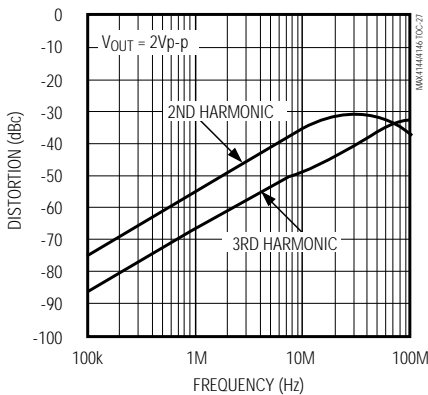

MAX4144
5MHz HARMONIC DISTORTION
vs. LOAD ($A_V = +2$)

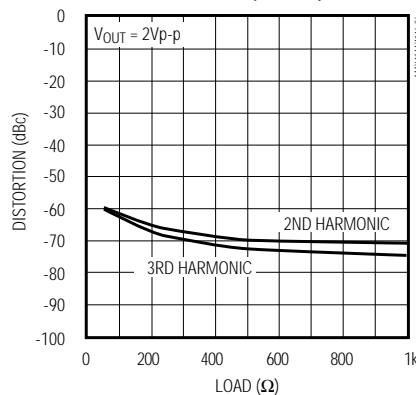

MAX4145
5MHz HARMONIC DISTORTION
vs. LOAD ($A_V = +1$)

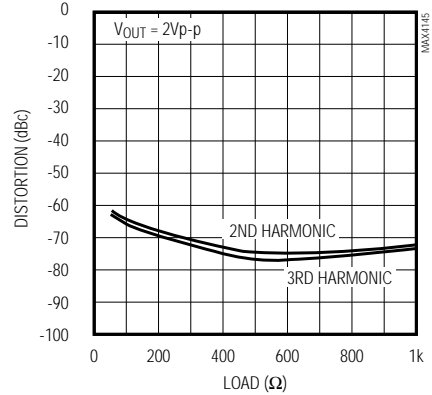

MAX4146
5MHz HARMONIC DISTORTION
vs. LOAD ($A_V = +10$)

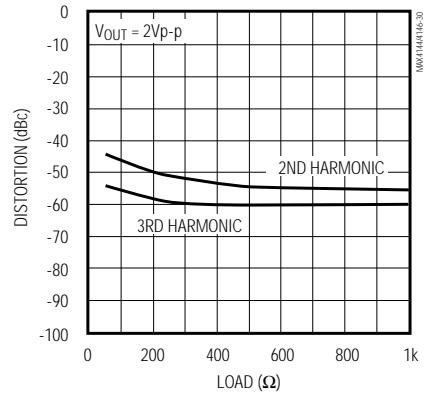

MAX4146
5MHz HARMONIC DISTORTION
vs. LOAD ($A_V = +100$)

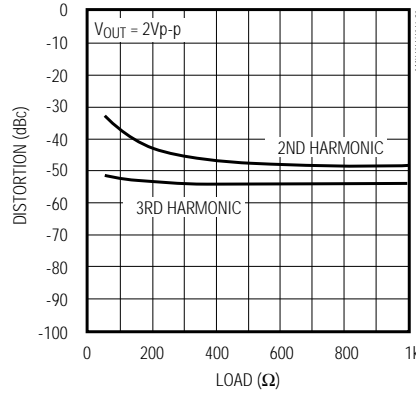

MAX4144
5MHz HARMONIC DISTORTION
vs. OUTPUT SWING ($A_V = +2$)

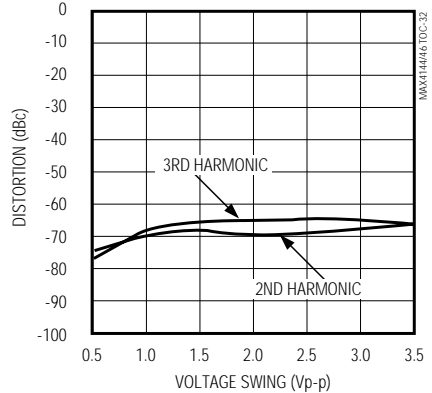

High-Speed, Low-Distortion, Differential Line Receivers

Typical Operating Characteristics (continued)

($V_{CC} = +5V$, $V_{EE} = -5V$, $SHDN = 0V$, $R_L = 150\Omega$, $T_A = +25^\circ C$, unless otherwise noted.)

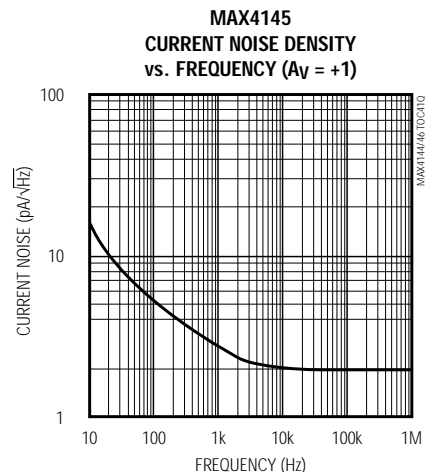
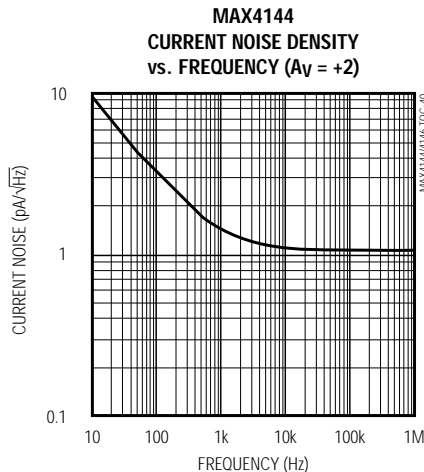
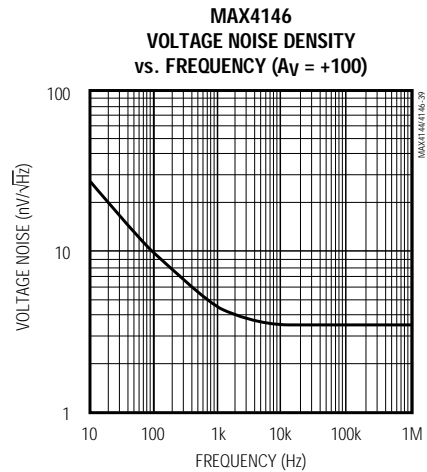
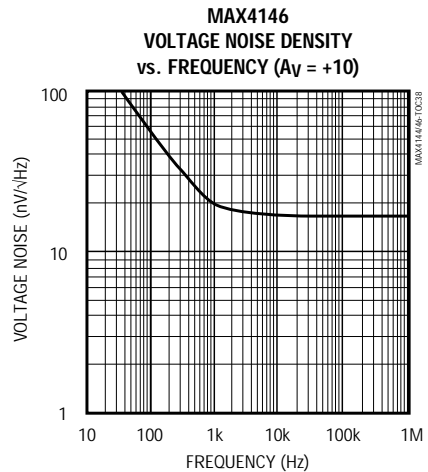
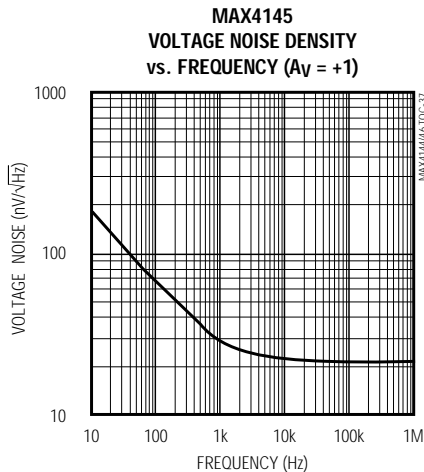
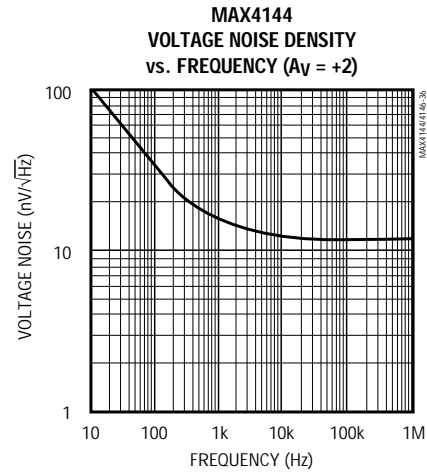
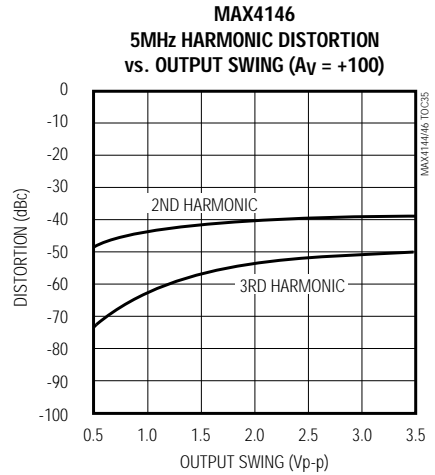
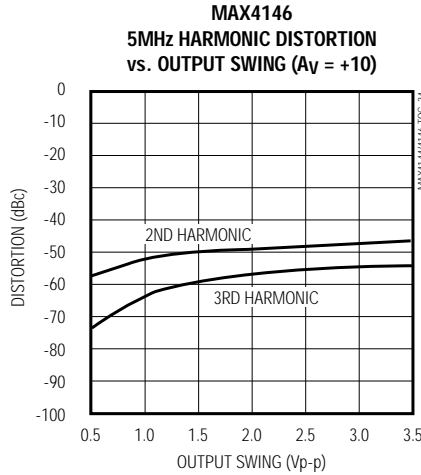
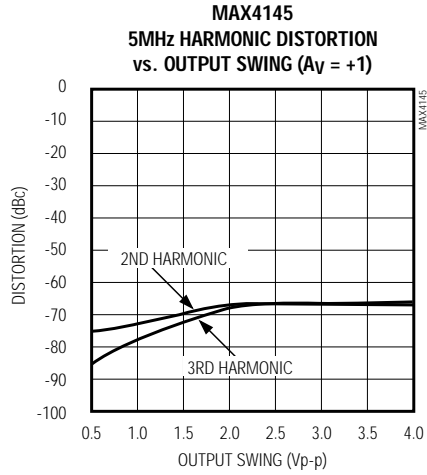

High-Speed, Low-Distortion, Differential Line Receivers

Typical Operating Characteristics (continued)

($V_{CC} = +5V$, $V_{EE} = -5V$, $SHDN = 0V$, $R_L = 150\Omega$, $T_A = +25^\circ C$, unless otherwise noted.)

MAX4144/MAX4145/MAX4146

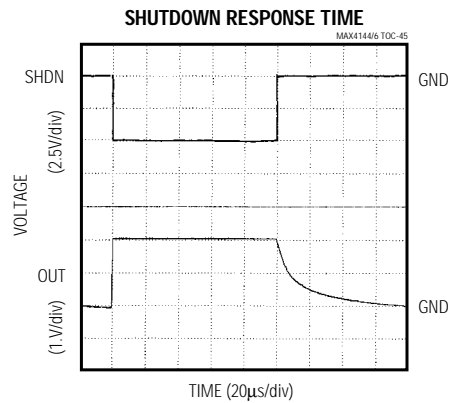
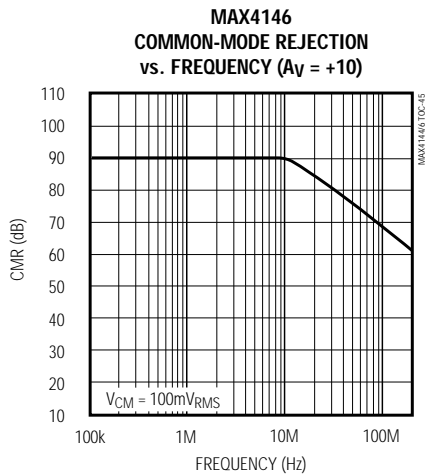
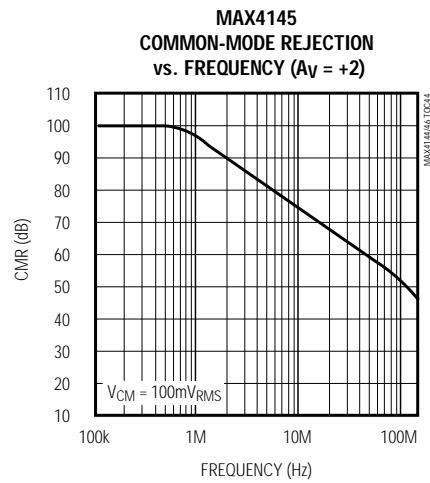
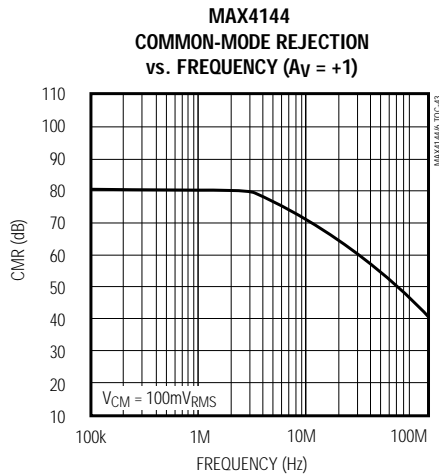
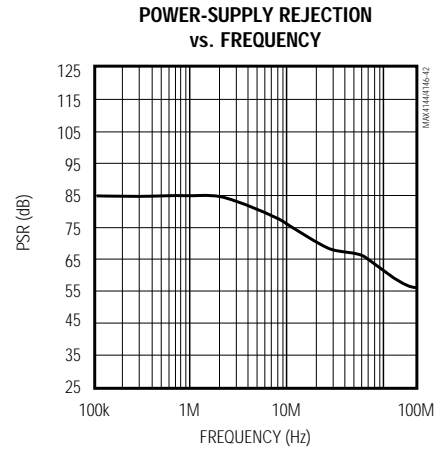
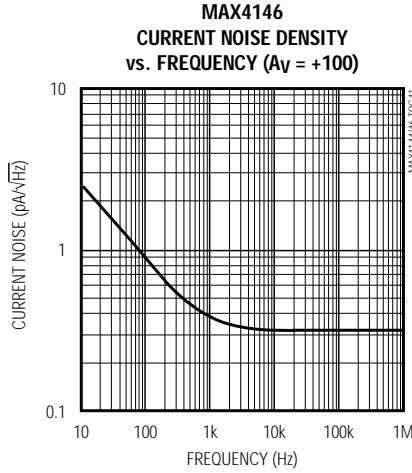
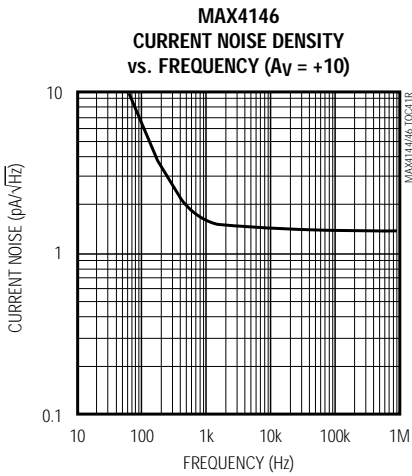

High-Speed, Low-Distortion, Differential Line Receivers

Pin Description

PIN						NAME	FUNCTION
MAX4144		MAX4145		MAX4146			
14 SO	16 QSOP	14 SO	16 QSOP	14 SO	16 QSOP		
1, 7	1, 7	1, 7	1, 7	1, 7	1, 7	V _{EE}	Negative Power Supply
2	2	2	2	2	2	IN-	Inverting Input
3, 5, 10, 12	3, 5, 8, 9, 12, 14	10, 12	12, 14	10, 12	12, 14	N.C.	No Connect. Not internally connected.
—	—	3	3	3	3	RG-	Inverting Input for Gain-Set Resistor
4	4	4	4	4	4	SHDN	Logic Input for Shutdown Circuitry. A logic low enables the amplifier. A logic high disables the amplifier.
—	—	5	5	5	5	RG+	Noninverting Input for Gain-Set Resistor
6	6	6	6	6	6	IN+	Noninverting Input
8, 14	10, 16	8, 14	10, 16	8, 14	10, 16	V _{CC}	Positive Power Supply
9	11	9	11	9	11	REF	Output Reference. Connect to ground for normal operation.
11	13	11	13	11	13	OUT	Output
13	15	13	15	13	15	SENSE	Output Sense. Connect to OUT close to the pin for normal operation.

Detailed Description

The MAX4144/MAX4145/MAX4146 are low-distortion, differential line receivers that feature high bandwidths and excellent common-mode rejection, making them ideal for balanced, high-speed data transmission systems.

The MAX4144 has a preset gain of +2V/V and achieves a 130MHz -3dB bandwidth, a 1000V/μs slew rate, and common-mode rejection (CMR) of 70dB at 10MHz. The MAX4145 and MAX4146 use a single external resistor to set the closed-loop gain from +1V/V to +10V/V for the MAX4145, or greater than +10V/V for the MAX4146. The MAX4145 achieves a -3dB bandwidth of 180MHz, a slew rate of 600V/μs, and CMR of 75dB at 10MHz when operating in the unity-gain configuration. The MAX4146 attains a -3dB bandwidth of 70MHz, a slew rate of 800V/μs, and CMR of 90dB at 10MHz when operating with a closed-loop gain of +10V/V.

Differential inputs make the MAX4144/MAX4145/MAX4146 ideal for applications with high common-

mode noise, such as receiving T1 or xDSL transmissions over a twisted-pair cable. Excellent differential gain and phase, along with low noise, also suit them to video applications and RF signal processing.

For a complete differential transmission link, use the MAX4144/MAX4145/MAX4146 amplifiers with the MAX4147 line driver, as shown in the *Typical Application Circuit*.

Applications Information

Grounding, Bypassing, and PC Board Layout

Adhere to the following high-frequency design techniques when designing the PC board for the MAX4144/MAX4145/MAX4146.

- The printed circuit board should have at least two layers: the signal layer and the ground plane.
- Do not use wire-wrap boards—they are too inductive.

High-Speed, Low-Distortion, Differential Line Receivers

- Do not use IC sockets—they increase parasitic capacitance and inductance.
- Use surface-mount power-supply bypass capacitors instead of through-hole capacitors. Their shorter lead lengths reduce parasitic inductance, leading to superior high-frequency performance.
- Keep signal lines as short and as straight as possible. Do not make 90° turns; round all corners.
- The ground plane should be as free from voids as possible.

Output Short-Circuit Protection

Under short-circuit conditions to ground, limit the output current to 120mA. This level is low enough that a short to ground of moderate duration will not cause permanent damage to the chip. However, a short to either supply will significantly increase power dissipation, and will cause permanent damage. The high output current capability is an advantage in systems that transmit a signal to several loads.

Input Protection Circuitry

The MAX4144/MAX4145/MAX4146 include internal protection circuitry that prevents damage to the precision input stage from large differential input voltages. This protection circuitry consists of five back-to-back Schottky protection diodes between IN+ and RG+, and IN- and RG- (Figure 1). The diodes limit the differential voltage applied to the amplifiers' internal circuitry to no more than 10V_F, where V_F is the diode's forward voltage drop (about 0.4V at +25°C).

For a large differential input voltage (exceeding 4V), the MAX4145/MAX4146 input bias current (at IN+ and IN-) increases according to the following equation:

$$\text{Input Current} = \frac{(V_{IN+} - V_{IN-} - 10V_F)}{R_G}$$

The MAX4144 has an internal gain-setting resistor valued at 1.4kΩ. A differential input voltage as high as 10V will cause only 4.3mA to flow—much less than the 10mA absolute maximum rating. However, in the MAX4145/MAX4146, R_G can be as low as 150Ω. Under this condition, the absolute maximum input current rating might be exceeded if the differential input voltage exceeds 5.5V (10mA x 150Ω + 10V_F). In that case, 510Ω resistors can be placed at IN+ and IN- to limit the current without degrading performance.

Shutdown Mode

The MAX4144/MAX4145/MAX4146 can be put into low-power shutdown mode by bringing SHDN high. The amplifier output is high impedance in this mode; thus the impedance at OUT is that of the feedback resistors (1.4kΩ).

Setting Gain (MAX4145/MAX4146)

The MAX4145/MAX4146's gain is determined by a single external resistor, R_G. The optimal gain range is from +1V/V to +10V/V for the MAX4145 and +10V/V (R_G = open) to +100V/V for the MAX4146. The gain (in V/V) is given in the following equations:

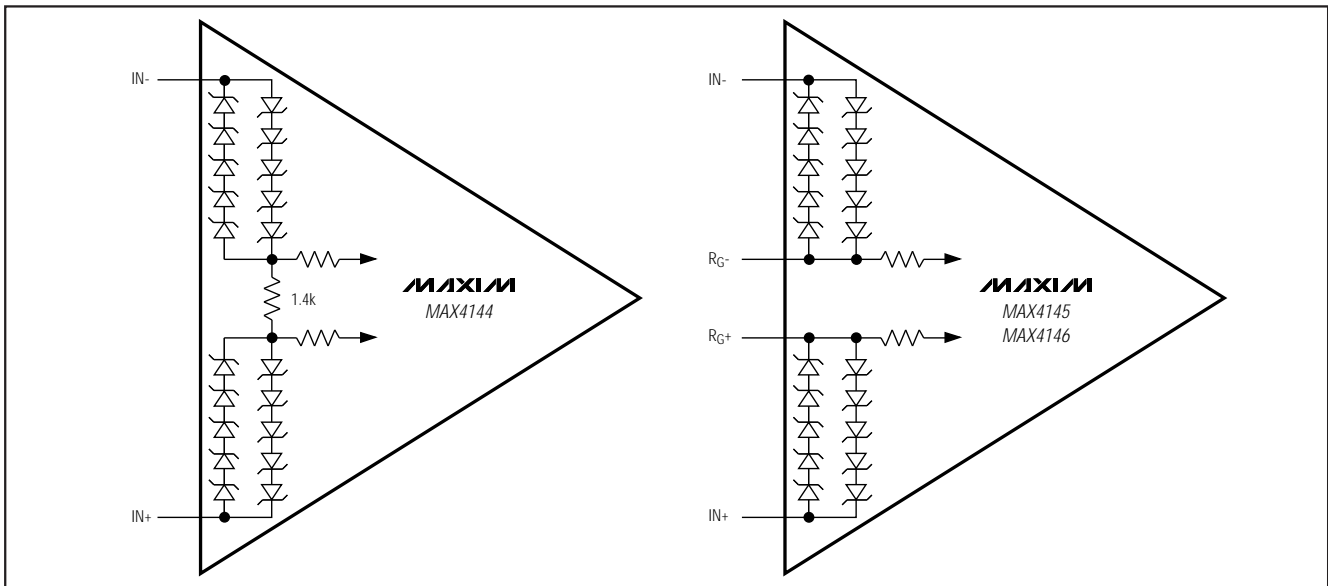

Figure 1. Input Protection Circuits

High-Speed, Low-Distortion, Differential Line Receivers

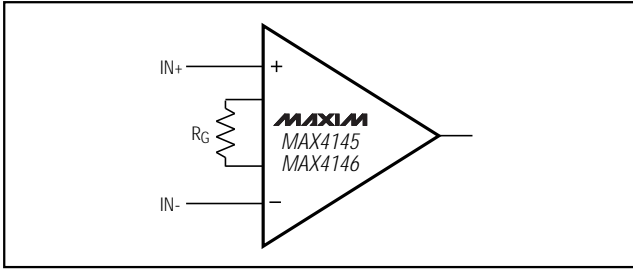

Figure 2. Connection of R_G in MAX4146

$$G = A_V = 1 + \frac{1.4k\Omega}{R_G} \quad (\text{MAX4145})$$

$$G = A_V = 10 + \frac{14k\Omega}{R_G} \quad (\text{MAX4146})$$

Figure 2 shows the connection for R_G . R_G might simply be a resistor, or it can be a complex pole-zero pair for filter and shaping applications (Figure 9). Use surface-mount gain-setting components to ensure stability.

Using REF and SENSE

The MAX4144/MAX4145/MAX4146 have a REF pin (normally connected to ground) and a SENSE pin (normally connected to OUT). In some long-line applications, it may be desirable to connect SENSE and OUT together at the load, instead of the typical connection at the part (Figure 3). This compensates for the long line's resistance, which otherwise leads to an IR voltage error.

When using this technique, keep the sense lines' impedance low to minimize gain errors. Also, keep capacitance low to maximize frequency response. The gain of the MAX4144/MAX4145/MAX4146 output stage is approximated by the following equation:

$$A_V = \frac{1}{2} \left[\frac{700\Omega + \Delta R_{SENSE}}{R} \left(1 + \frac{700\Omega + \Delta R_{REF}}{R + 700\Omega + \Delta R_{REF}} \right) + \frac{700\Omega + \Delta R_{REF}}{R + 700\Omega + \Delta R_{REF}} \right]$$

where ΔR_{SENSE} and ΔR_{REF} are the SENSE and REF trace impedances, respectively. R is 700Ω for the MAX4144 and MAX4145, and 100Ω for the MAX4146.

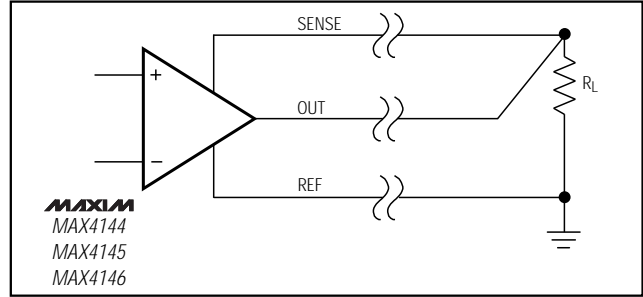

Figure 3. Connection of SENSE and REF to a Remote Load

Additionally, mismatches in the SENSE and REF traces lead to common-mode gain errors. Common-mode gain is approximated by the following equation:

$$A_{VCM} = \frac{\Delta R_{REF} - \Delta R_{SENSE}}{R + 700\Omega}$$

Substituting numbers for ΔR_{REF} and ΔR_{SENSE} into this equation, we can see that if changes in ΔR_{REF} and ΔR_{SENSE} are equal, CMR is not degraded.

Driving Capacitive Loads

The MAX4144/MAX4145/MAX4146 provide maximum AC performance when not driving an output load capacitance. This is the case when driving a correctly terminated transmission line (i.e., a back-terminated cable). In most amplifier circuits, driving large load capacitance increases the chance of oscillations. The amplifier's output impedance and the load capacitor combine to add a pole and excess phase to the loop response. If the pole's frequency is low enough and phase margin is degraded sufficiently, oscillations may occur. A second concern when driving capacitive loads results from the amplifier's output impedance,

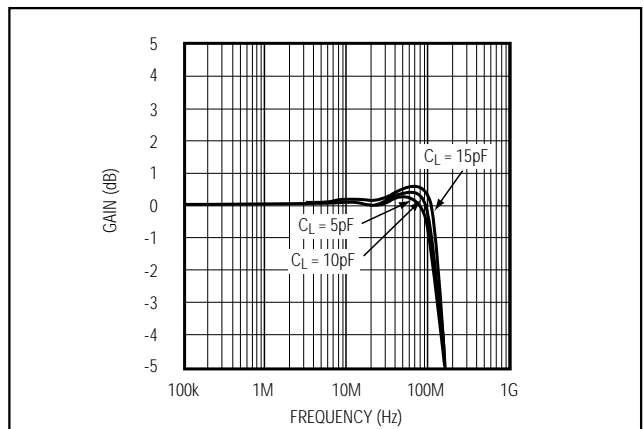

Figure 4. MAX4144 Small-Signal Response with Capacitive Load

High-Speed, Low-Distortion, Differential Line Receivers

MAX4144/MAX4145/MAX4146

which appears inductive at high frequencies. This inductance forms an L-C resonant circuit with the capacitive load, which causes peaking in the frequency response and degrades the amplifier's phase margin.

The MAX4144/MAX4145/MAX4146 drive capacitive loads up to 25pF without oscillation. However, some peaking may occur in the frequency domain (Figure 4).

To drive larger capacitance and reduce ringing, add an isolation resistor (R_{ISO}) between the amplifier's output and the load (Figure 5).

The value of R_{ISO} depends on the circuit's gain and the capacitive load (Figures 6 and 7). With higher capaci-

tive values, bandwidth is dominated by the RC network formed by R_{ISO} and C_L ; the bandwidth of the amplifier itself is much higher. Also note that the isolation resistor forms a divider that decreases the voltage delivered to the load.

Twisted-Pair Line Receiver

The MAX4144/MAX4145/MAX4146 are well suited as receivers in twisted-pair xDSL or NTSC/PAL video applications. The standard 24AWG telephone wire widely used in these applications is a lossy medium for high-frequency signals. The losses in NTSC video applications are almost 15dB per 1000 feet (Figure 8).

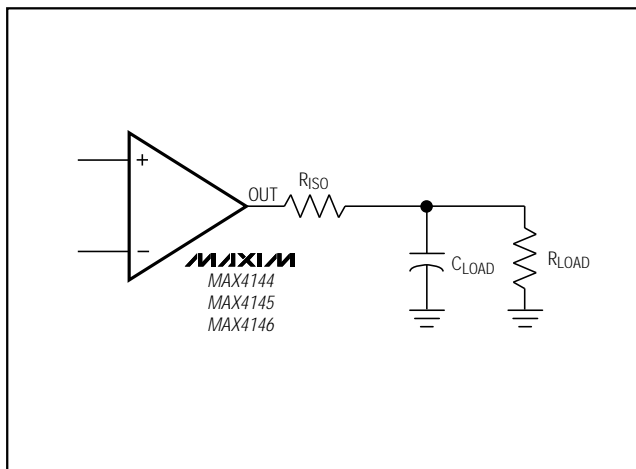

Figure 5. Addition of R_{ISO} to Amplifier Output

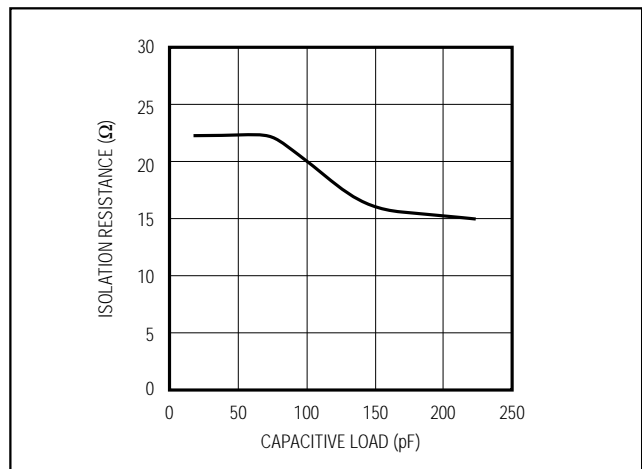

Figure 6. MAX4144 Isolation Resistance vs. Capacitive Load

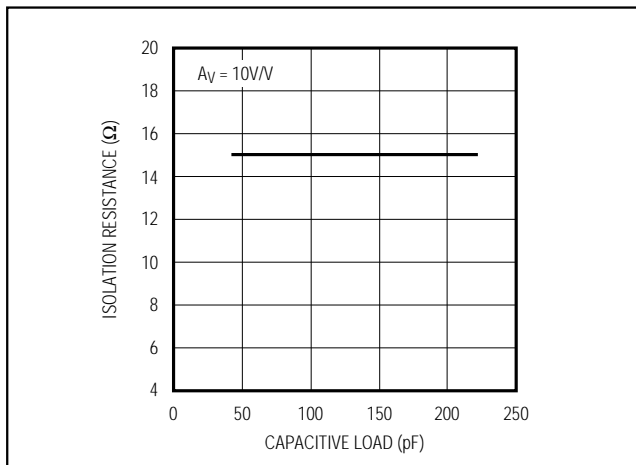

Figure 7. MAX4145/MAX4146 Isolation Resistance vs. Capacitive Load

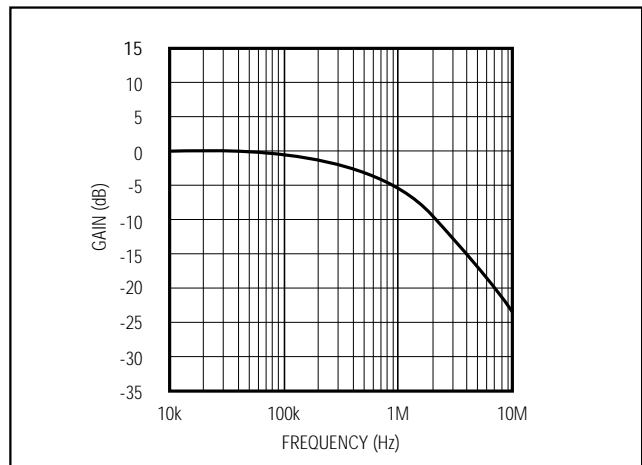

Figure 8. 1000 Feet of AWG24 Twisted-Pair Telephone Cable (Gain vs. Frequency)

High-Speed, Low-Distortion, Differential Line Receivers

Losses are higher at higher frequencies, contributing to severe pulse-edge rounding in digital applications. The nominal impedance of twisted-pair telephone wire is 110Ω.

The MAX4145/MAX4146, with variable gain up to +10V/V and +100V/V, respectively, can be used to compensate for cable losses. In the graph shown in Figure 8, the cable characteristics are such that the video-chroma frequency loss is almost 15dB greater

than the low-frequency loss. The losses can be compensated for by using the RC-shaping network (Figure 9).

A 560Ω resistance and a 100pF capacitance shape the MAX4146 gain to inversely match the frequency of the 1000 feet of telephone cable. The differential gain and phase, using the circuit shown in Figure 9, is 0.55% and 0.18°, respectively.

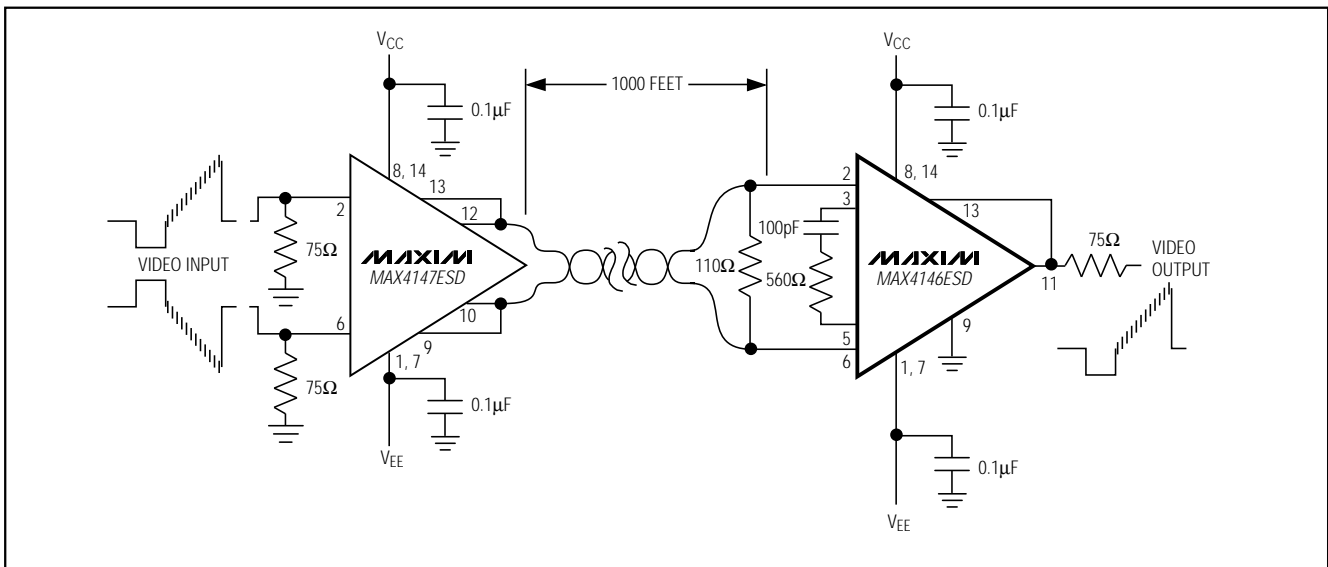
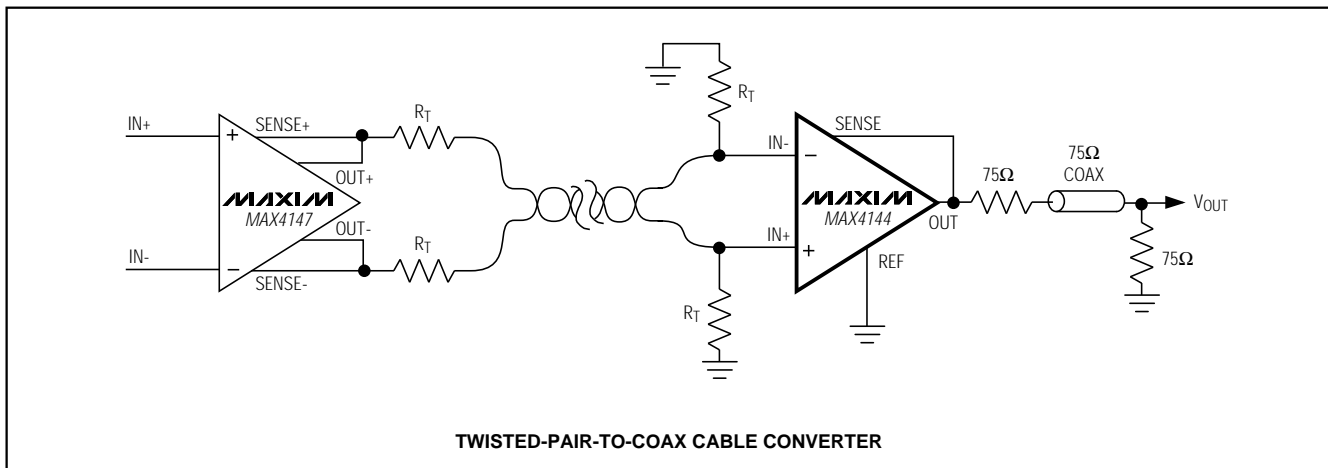

Figure 9. Circuit for Transmitting NTSC/PAL Video Over 1000 Feet of Twisted-Pair Telephone Line

Typical Application Circuit



High-Speed, Low-Distortion, Differential Line Receivers

Pin Configurations

MAX4144/MAX4145/MAX4146

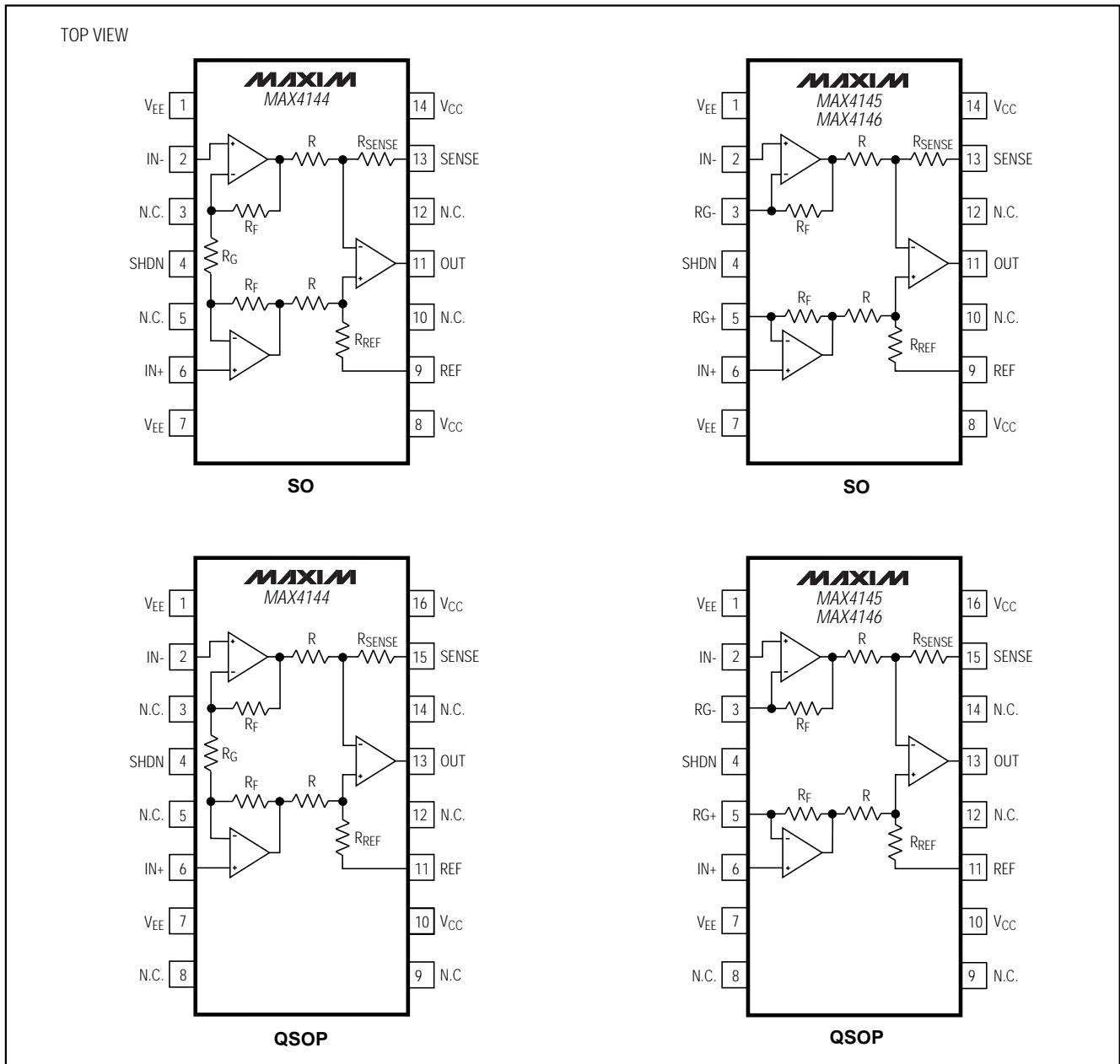

Chip Information

TRANSISTOR COUNT: 237

SUBSTRATE CONNECTED TO V_{EE}

High-Speed, Low-Distortion, Differential Line Receivers

Package Information

DIM	INCHES		MILLIMETERS	
	MIN	MAX	MIN	MAX
A	.061	.068	1.55	1.73
A1	.004	.0098	0.127	0.25
A2	.055	.061	1.40	1.55
B	.008	.012	0.20	0.31
C	.0075	.0098	0.19	0.25
D	SEE VARIATIONS			
E	.150	.157	3.81	3.99
e	.025 BSC		0.635 BSC	
H	.230	.244	5.84	6.20
h	.010	.016	0.25	0.41
L	.016	.035	0.41	0.89
N	SEE VARIATIONS			
S	SEE VARIATIONS			
?	0°	8°	0°	8°

DIM	INCHES		MILLIMETERS		N
	MIN.	MAX.	MIN.	MAX.	
D	.189	.196	4.80	4.98	16 AA
S	.0020	.0070	0.05	0.18	
D	.337	.344	8.56	8.74	20 AB
S	.0500	.0550	1.27	1.40	
D	.337	.344	8.56	8.74	24 AC
S	.0250	.0300	0.64	0.76	
D	.386	.393	9.80	9.98	28 AD
S	.0250	.0300	0.64	0.76	

NOTES:

- D & E DO NOT INCLUDE MOLD FLASH OR PROTRUSIONS
- MOLD FLASH OR PROTRUSIONS NOT TO EXCEED .006"
- CONTROLLING DIMENSIONS: INCHES

MAXIM
PROPRIETARY INFORMATION
 TITLE:
 PACKAGE OUTLINE, QSDP, .150 INCH, .025" LEAD PITCH
 APPROVAL: _____ DOCUMENT CONTROL: NCI REV: A 1/1
 21-0055

DIM	INCHES		MILLIMETERS	
	MIN	MAX	MIN	MAX
A	0.053	0.069	1.35	1.75
A1	0.004	0.010	0.10	0.25
B	0.014	0.019	0.35	0.49
C	0.007	0.010	0.19	0.25
e	0.050		1.27	
E	0.150	0.157	3.80	4.00
H	0.228	0.244	5.80	6.20
h	0.010	0.020	0.25	0.50
L	0.016	0.050	0.40	1.27

DIM	INCHES		MILLIMETERS		N	MS012
	MIN	MAX	MIN	MAX		
D	0.189	0.197	4.80	5.00	8	A
D	0.337	0.344	8.55	8.75	14	B
D	0.386	0.394	9.80	10.00	16	C

NOTES:

- D&E DO NOT INCLUDE MOLD FLASH
- MOLD FLASH OR PROTRUSIONS NOT TO EXCEED .006"
- LEADS TO BE COPLANAR WITHIN .102mm (.004")
- CONTROLLING DIMENSION: MILLIMETER
- MEETS JEDEC MS012-XX AS SHOWN IN ABOVE TABLE
- N = NUMBER OF PINS

MAXIM
PROPRIETARY INFORMATION
 PACKAGE FAMILY OUTLINE: SOIC .150" 1/1 21-0041 A

Maxim cannot assume responsibility for use of any circuitry other than circuitry entirely embodied in a Maxim product. No circuit patent licenses are implied. Maxim reserves the right to change the circuitry and specifications without notice at any time.