

6MBI10S-120

IGBT Modules

IGBT MODULE (S series) 1200V / 10A 6 in one-package

■ Features

- Compact package
- P.C.board mount
- Low $V_{CE(sat)}$

■ Applications

- Inverter for motor drive
- AC and DC servo drive amplifier
- Uninterruptible power supply
- Industrial machines, such as welding machines

■ Maximum ratings and characteristics

● Absolute maximum ratings ($T_c=25^\circ\text{C}$ unless otherwise specified)

Item	Symbol	Rating	Unit	
Collector-Emitter voltage	V_{CES}	1200	V	
Gate-Emitter voltage	V_{GES}	± 20	V	
Collector current	Continuous	$T_c=25^\circ\text{C}$	15	A
		$T_c=80^\circ\text{C}$	10	
	1ms	$T_c=25^\circ\text{C}$	30	A
		$T_c=80^\circ\text{C}$	20	
	1ms	-Ic	10	A
	-Ic pulse	20	A	
Max. power dissipation (1 device)	Pc	75	W	
Operating temperature	T_j	+150	$^\circ\text{C}$	
Storage temperature	T_{stg}	-40 to +125	$^\circ\text{C}$	
Isolation voltage	V_{is}	AC 2500 (1min.)	V	
Screw torque	Mounting *1	3.5	N·m	

*1 : Recommendable value : 2.5 to 3.5 N·m (M5)

● Electrical characteristics ($T_j=25^\circ\text{C}$ unless otherwise specified)

Item	Symbol	Characteristics			Conditions	Unit	
		Min.	Typ.	Max.			
Zero gate voltage collector current	I_{CES}	-	-	1.0	$V_{GE}=0\text{V}$, $V_{CE}=1200\text{V}$	mA	
Gate-Emitter leakage current	I_{GES}	-	-	0.2	$V_{CE}=0\text{V}$, $V_{GE}=\pm 20\text{V}$	μA	
Gate-Emitter threshold voltage	$V_{GE(th)}$	5.5	7.2	8.5	$V_{CE}=20\text{V}$, $I_C=10\text{mA}$	V	
Collector-Emitter saturation voltage	$V_{CE(sat)}$	-	2.3	2.6	$T_j=25^\circ\text{C}$	$V_{GE}=15\text{V}$, $I_C=10\text{A}$	V
		-	2.8	-	$T_j=125^\circ\text{C}$		
Input capacitance	C_{ies}	-	1200	-	$V_{GE}=0\text{V}$	pF	
Output capacitance	C_{oes}	-	250	-	$V_{CE}=10\text{V}$		
Reverse transfer capacitance	C_{res}	-	220	-	$f=1\text{MHz}$	μs	
Turn-on time	t_{on}	-	0.35	1.2	$V_{CC}=600\text{V}$		
	t_r	-	0.25	0.6	$I_C=10\text{A}$		
	$t_{r(i)}$	-	0.1	-	$V_{GE}=\pm 15\text{V}$		
Turn-off time	t_{off}	-	0.45	1.0	$R_G=120\text{ohm}$		
	t_f	-	0.08	0.3			
Diode forward on voltage	V_F	-	2.5	3.3	$T_j=25^\circ\text{C}$	$I_F=10\text{A}$, $V_{GE}=0\text{V}$	V
		-	2.0	-	$T_j=125^\circ\text{C}$		
Reverse recovery time	t_{rr}	-	-	0.35	$I_F=10\text{A}$	μs	

● Thermal resistance characteristics

Item	Symbol	Characteristics			Conditions	Unit
		Min.	Typ.	Max.		
Thermal resistance	$R_{th(j-c)}$	-	-	1.67	IGBT	$^\circ\text{C/W}$
	$R_{th(j-c)}$	-	-	2.78	FWD	$^\circ\text{C/W}$
	$R_{th(c-f)}^*2$	-	0.05	-	the base to cooling fin	$^\circ\text{C/W}$

*2 : This is the value which is defined mounting on the additional cooling fin with thermal compound



■ Equivalent circuit

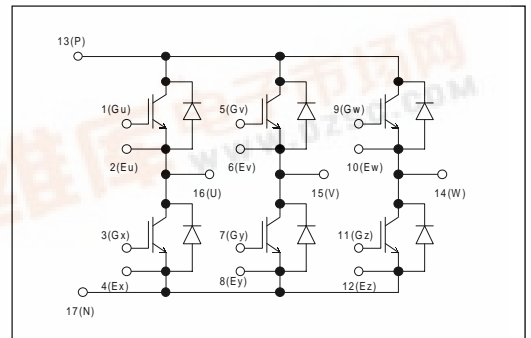

Characteristics

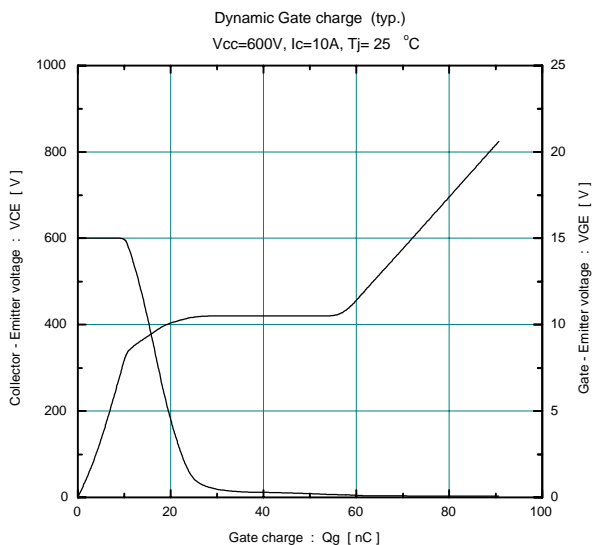
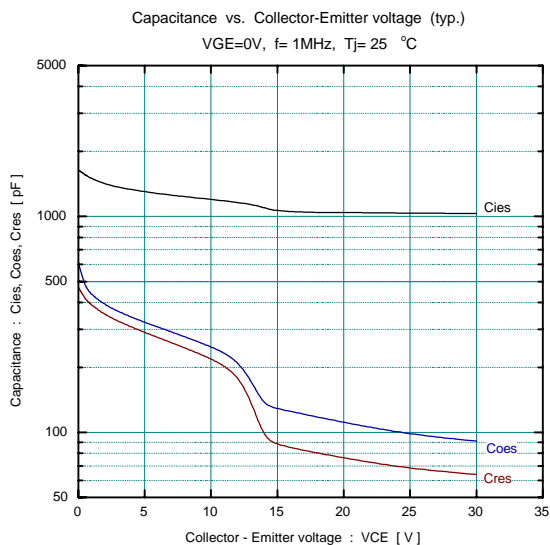
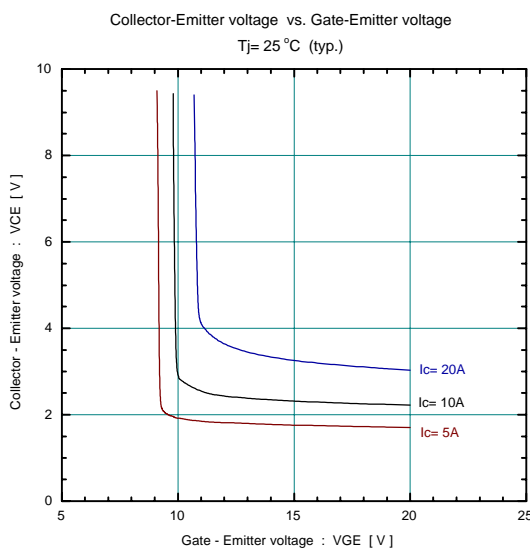
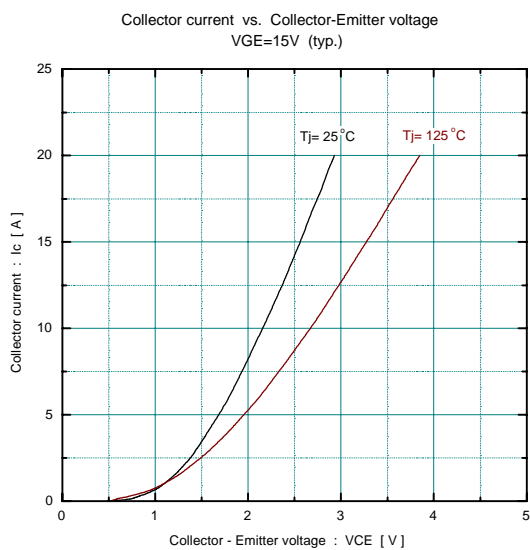
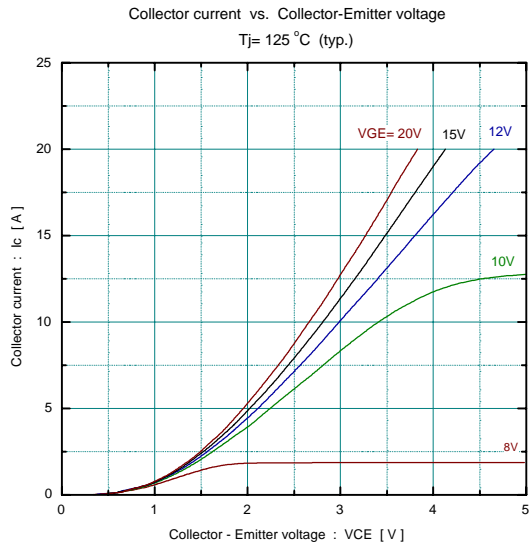
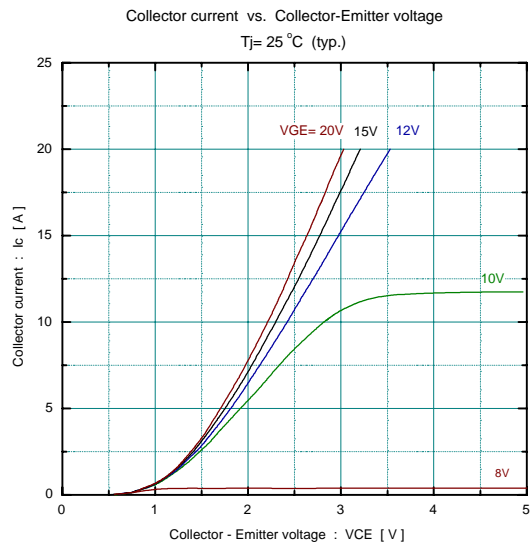

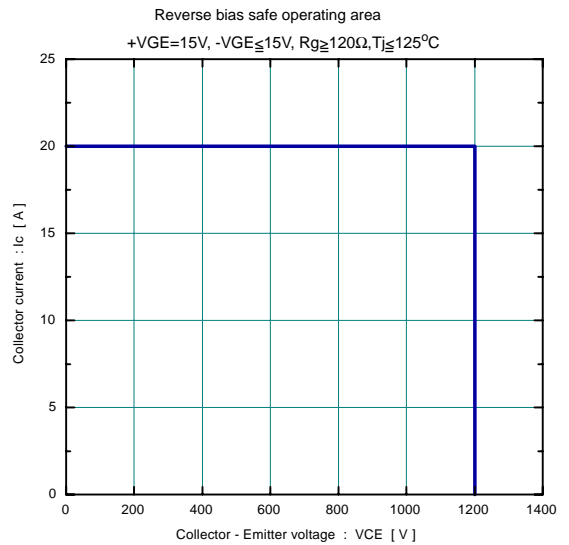
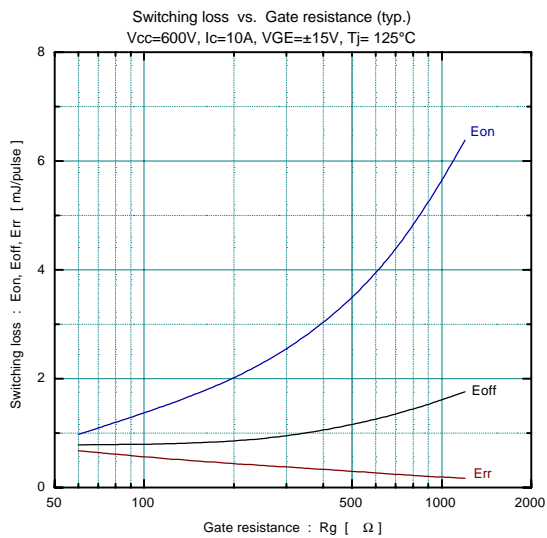
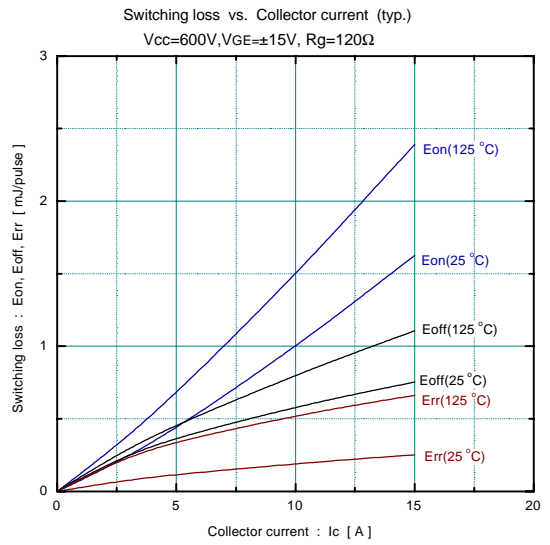
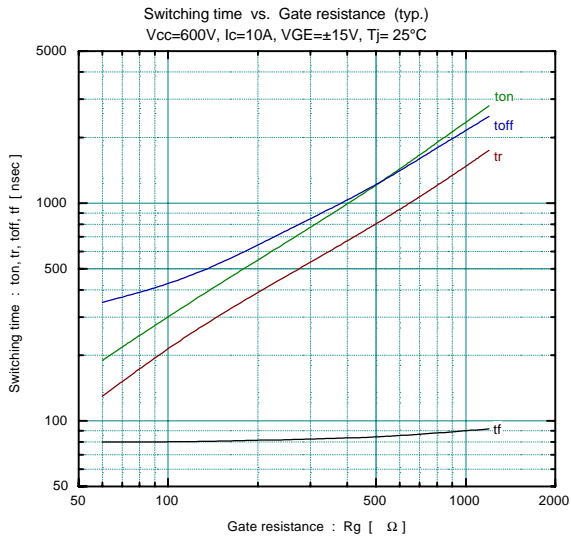
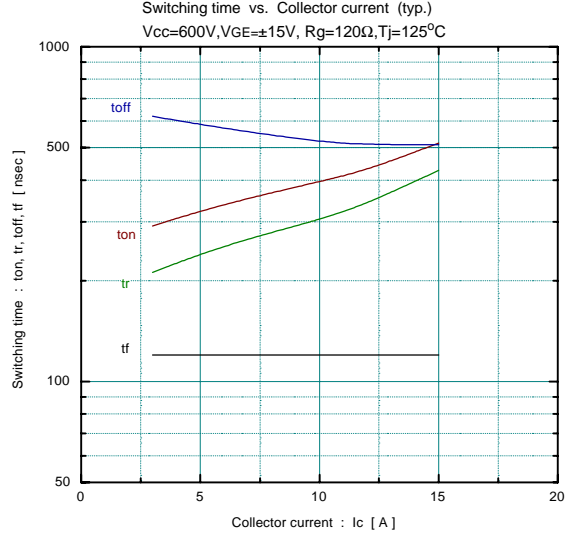
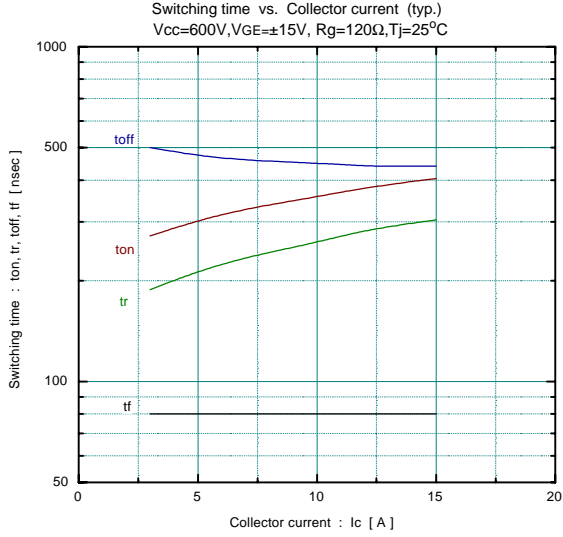

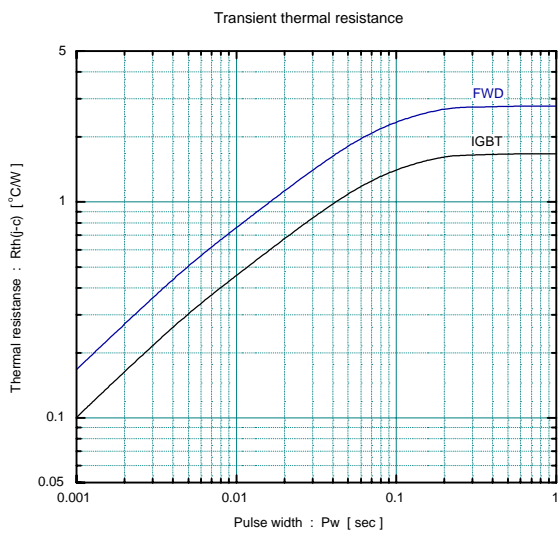
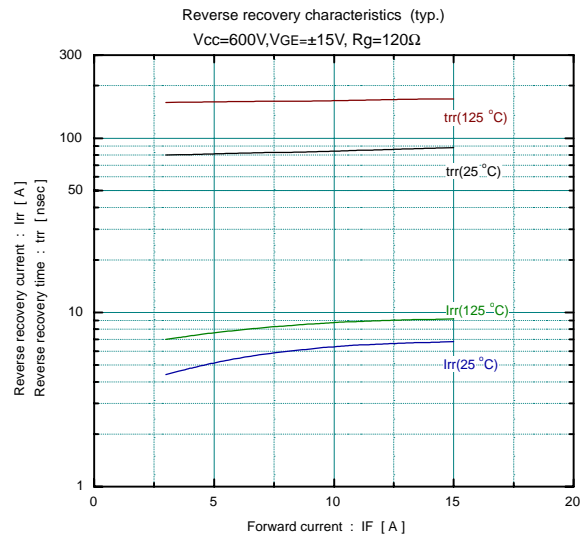
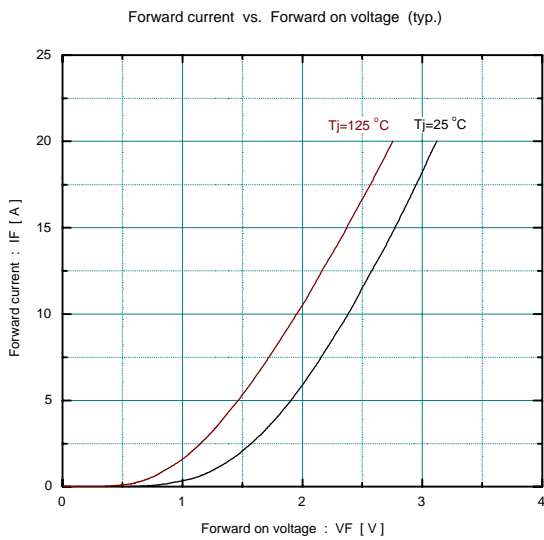

■ Outline Drawings, mm

