



Description

PT2271A is a remote control decoder paired with PT2261A utilizing CMOS Technology. It has 12 bits of two-state address pins providing a maximum of 4096 (or 2^{12}) address codes; thereby, drastically reducing any code collision and unauthorized code scanning possibilities. PT2271A is available in several options to suit every application need : variable number of data output pins, latch or momentary output type.

Features

- CMOS Technology
- Low Power Consumption
- Very High Noise Immunity
- Up to 12 Two-State Code Address Pins
- Up to 6 Data Pins
- Wide Range of Operating Voltage: $V_{cc} = 4 \sim 15$ Volts
- Single Resistor Oscillator
- Latch or Momentary Output Type
- Available in DIP and SO Package

Applications

- Car Security System
- Garage Door Controller
- Remote Control Fan
- Home Security/Automation System
- Remote Control Toys
- Remote Control for Industrial Use



Pin Configuration

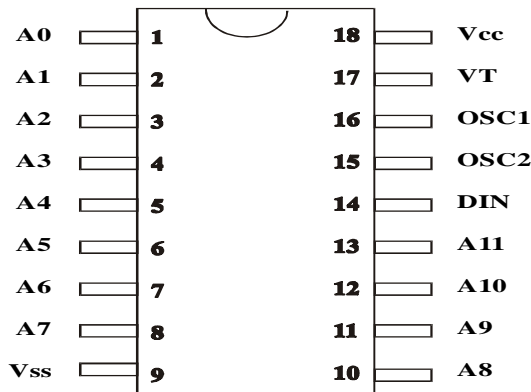

PT2271A

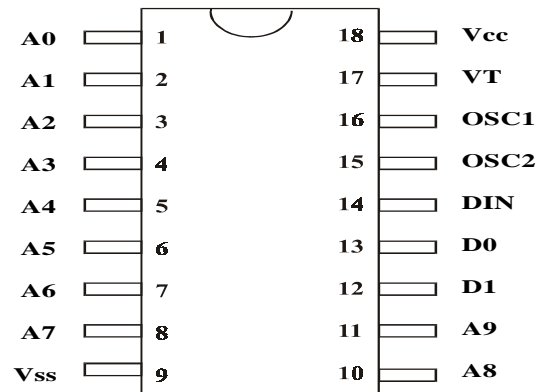

PT2271A - M2/L2

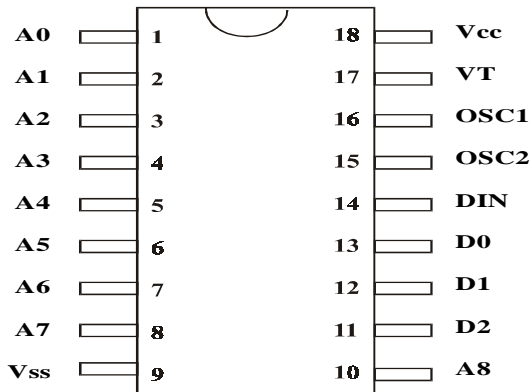

PT2271A - M3/L3

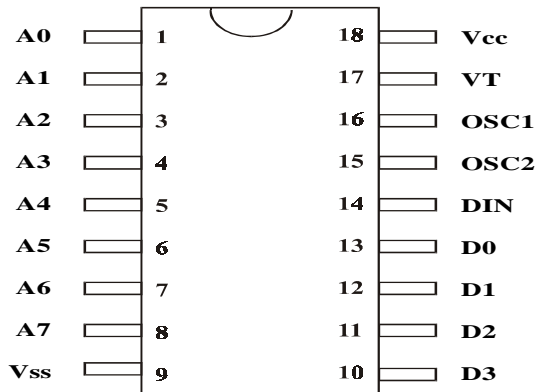

PT2271A - M4/L4

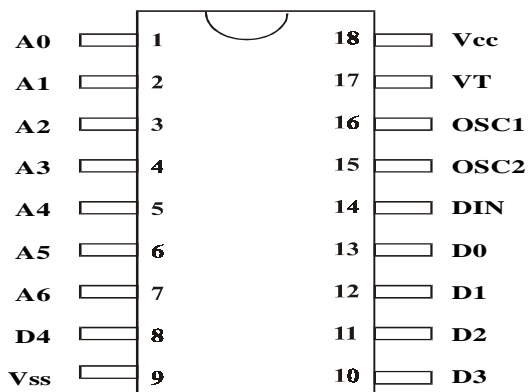

PT2271A - M5/L5

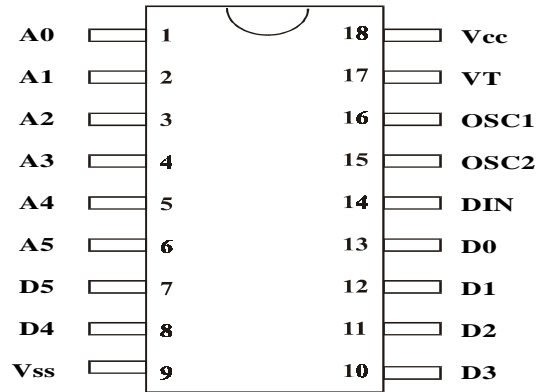

PT2271A - M6/L6



Remote Control Decoder

PT2271A

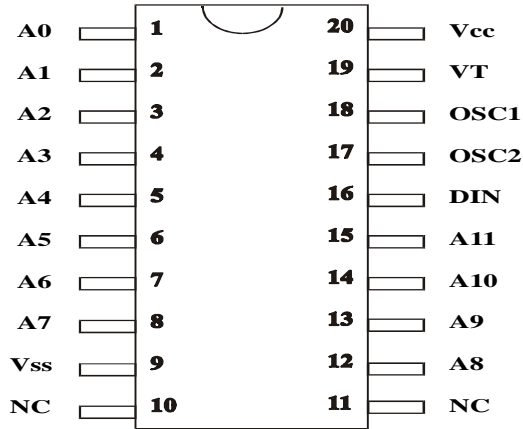

PT2271A (20 Pins)

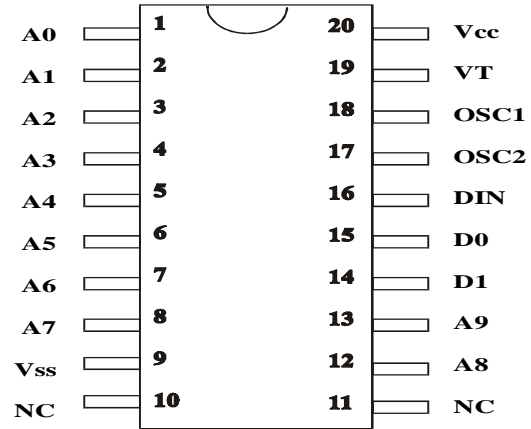

PT2271A - M2/L2 (20 Pins)

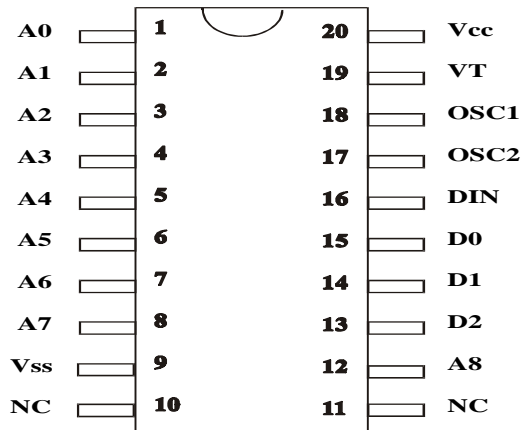

PT2271A - M3/L3 (20 Pins)

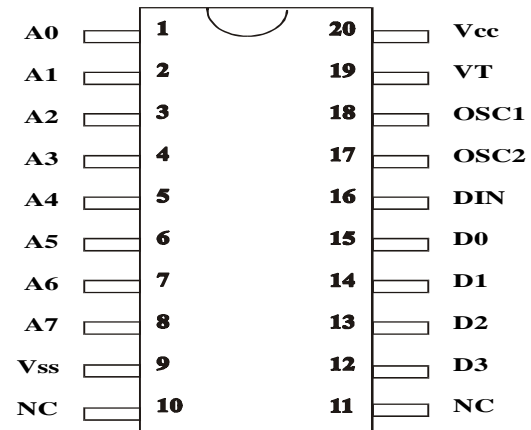

PT2271A - M4/L4 (20 Pins)

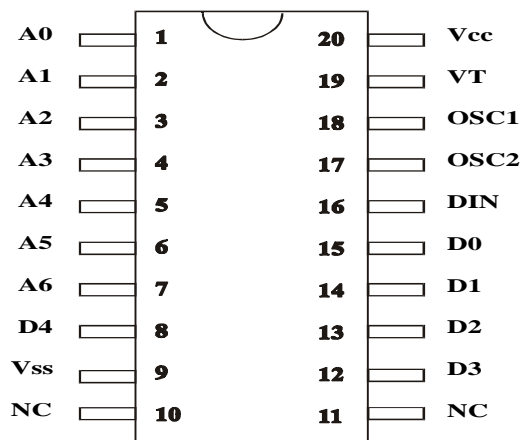

PT2271A - M5/L5 (20 Pins)

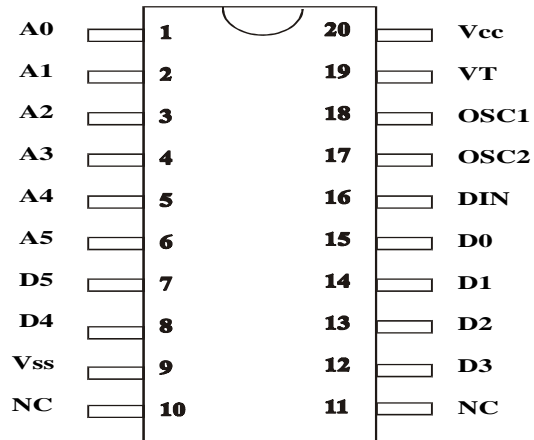

PT2271A - M6/L6 (20 Pins)



Application Circuit

PT2271A (4 Data) Application Circuit

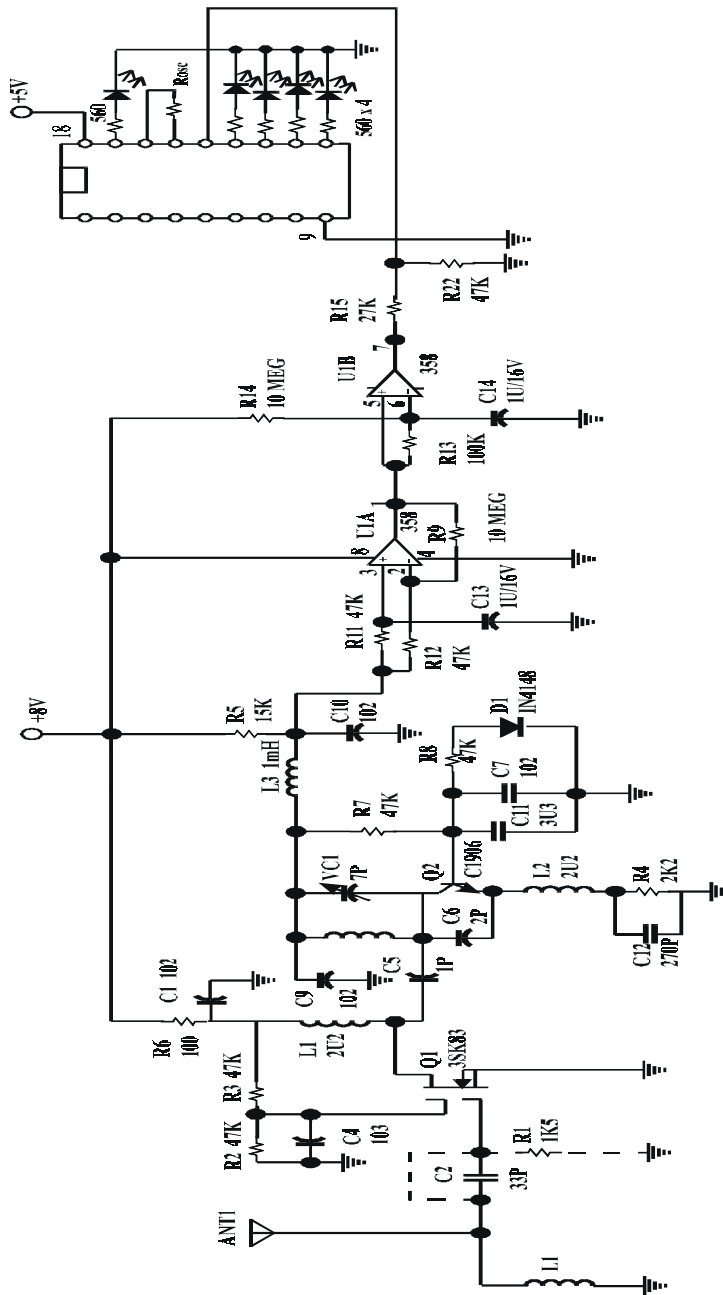

Note: If the Address Bit is "floating", the respective Code Bit will be set as "1".



Ordering Information

A. 18-Pin Package:

Part No.	Data Bit(s)	Output Type	Package
PT2271A (-S18)	None	*	DIP (SO)
PT2271A-L2 (-S18)	2	Latch	DIP (SO)
PT2271A-M2 (-S18)	2	Momentary	DIP (SO)
PT2271A-L3 (-S18)	3	Latch	DIP (SO)
PT2271A-M3 (-S18)	3	Momentary	DIP (SO)
PT2271A-L4 (-S18)	4	Latch	DIP (SO)
PT2271A-M4 (-S18)	4	Momentary	DIP (SO)
PT2271A-L5 (-S18)	5	Latch	DIP (SO)
PT2271A-M5 (-S18)	5	Momentary	DIP (SO)
PT2271A-L6 (-S18)	6	Latch	DIP (SO)
PT2271A-M6 (-S18)	6	Momentary	DIP (SO)

B. 20-Pin Package

Part No.	Data Bit(s)	Output Type	Package
PT2271A-S	None	*	SO
PT2271A-L2S	2	Latch	SO
PT2271A-M2S	2	Momentary	SO
PT2271A-L3S	3	Latch	SO
PT2271A-M3S	3	Momentary	SO
PT2271A-L4S	4	Latch	SO
PT2271A-M4S	4	Momentary	SO
PT2271A-L5S	5	Latch	SO
PT2271A-M5S	5	Momentary	SO
PT2271A-L6S	6	Latch	SO
PT2271A-M6S	6	Momentary	SO

Note: * = use VT (Valid Transmission)



Remote Control Decoder

PT2271A

PT 2271A - X X X

