



8V/1A, 5V/250mA Dual Regulator with Independent Output Enables and NoCap™

Description

The CS8371 is a 8V/5V dual output linear regulator. The 8V $\pm 5\%$ output sources 1A, while the 5V $\pm 5\%$ output sources 250mA. Each output is controlled by its own ENABLE lead. Setting the ENABLE input high turns on the associated regulator output. Holding both ENABLE inputs low puts the IC into sleep mode where current consumption is less than 10 μ A.

The regulator is protected against overvoltage, short-circuit and ther-

mal runaway conditions. The device can withstand 45V load dump transients making suitable for use in automotive environments. Cherry's proprietary NoCap™ solution is the first technology which allows the output to be stable without the use of an external capacitor.

The CS8371 is available in a 7 lead TO-220 package with copper tab. The tab can be connected to a heatsink if necessary.

Features

- Two Regulated Outputs
8V $\pm 5\%$, 1A
5V $\pm 5\%$, 250mA
- Independent ENABLE for each Output
- Separate Sense Feedback Lead for 8V Output
- <10 μ A Sleep Mode Current
- Fault Protection
Overvoltage Shutdown
+45V Peak Transient Voltage
Short Circuit
Thermal Shutdown
- CMOS Compatible, Low-Current ENABLE Inputs

Block Diagram

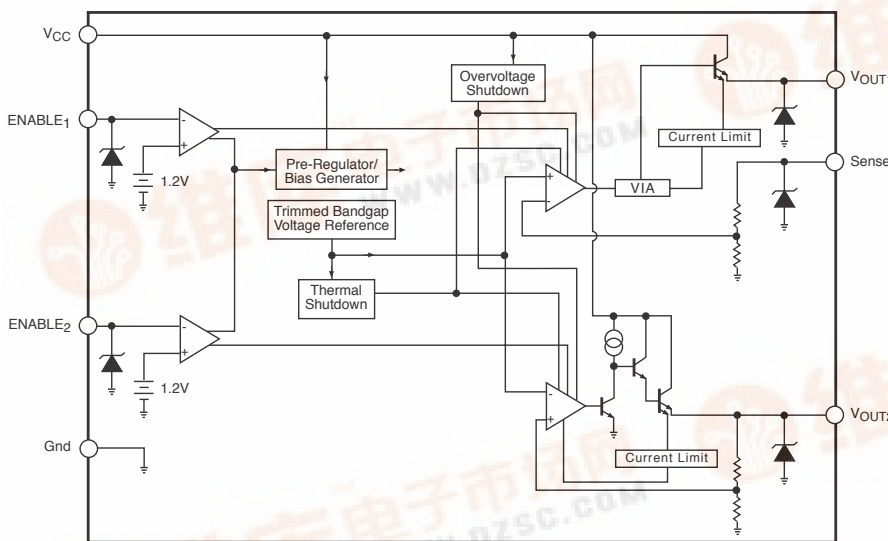

Package Options

TO-220 7 Lead

Tab (Gnd)

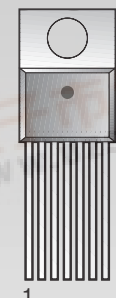

- 1 ENABLE₁
- 2 ENABLE₂
- 3 V_{OUT2}
- 4 Gnd
- 5 Sense
- 6 V_{CC}
- 7 V_{OUT1}

NoCap is a trademark of Cherry Semiconductor Corporation, and is patented.

Absolute Maximum Ratings

Power Dissipation.....	Internally Limited
ENABLE Input Voltage Range.....	-0.6V to +10.0V
Load Current (8V Regulator).....	Internally Limited
Load Current (5V Regulator).....	Internally Limited
Transient Peak Voltage (31V load dump @ 14V V_{CC}).....	45V
Storage Temperature Range.....	-65°C to +150°C
Junction Temperature Range.....	-40°C to +150°C
Lead Temperature Soldering: Wave Solder (through hole styles only).....	10 sec. max, 260°C peak

Electrical Characteristics: -40°C ≤ T_A ≤ +85°C, 10.5V ≤ V_{CC} ≤ 16.0V, ENABLE₁ = ENABLE₂ = 5.0V, I_{OUT1} = I_{OUT2} = 5.0mA, unless otherwise stated.

PARAMETER	TEST CONDITIONS	MIN	TYP	MAX	UNIT
■ Primary Output (V_{OUT1})					
Output Voltage	I _{OUT1} = 1.0A	7.60	8.00	8.40	V
Line Regulation	10.5V ≤ V _{CC} ≤ 26V			50	mV
Load Regulation	5mA ≤ I _{OUT1} ≤ 1.0A			150	mV
Sleep Mode Quiescent Current	V _{CC} = 14V, ENABLE ₁ = ENABLE ₂ = 0V	0	0.2	10.0	μA
Quiescent Current	V _{CC} = 14V, I _{OUT1} = 1.0A, I _{OUT2} = 250mA			30	mA
Dropout Voltage	I _{OUT1} = 250mA			1.2	V
Dropout Voltage	I _{OUT1} = 1.0A			1.5	V
Quiescent Bias Current	I _{OUT1} = 5mA, ENABLE ₂ = 0V, V _{CC} = 14V I _Q = I _{CC} - I _{OUT1}			10	mA
Quiescent Bias Current	I _{OUT1} = 1.0A, ENABLE ₂ = 0V, V _{CC} = 14V I _Q = I _{CC} - I _{OUT1}			22	mA
Ripple Rejection	f = 120Hz, V _{CC} = 14V with 1.0V _{PP} AC, C _{OUT} = 0μF		90		dB
	f = 10kHz, V _{CC} = 14V with 1.0V _{PP} AC, C _{OUT} = 0μF		74		dB
	f = 20kHz, V _{CC} = 14V with 1.0V _{PP} AC, C _{OUT} = 0μF		68		dB
Current Limit	V _{CC} = 16V	1.1		2.5	A
Overshoot Voltage	5mA ≤ I _{REG1} ≤ 1.0A			6.0	V
Output Noise	10Hz-100kHz		300		μV _{rms}
■ Secondary Output (V_{OUT2})					
Output Voltage	I _{OUT2} = 250mA	4.75	5.00	5.25	V
Line Regulation	7V ≤ V _{CC} ≤ 26V			40	mV
Load Regulation	5mA ≤ I _{OUT2} ≤ 250mA			100	mV
Dropout Voltage	I _{OUT2} = 5.0mA			2.2	V
Dropout Voltage	I _{OUT2} = 250mA			2.5	V
Quiescent Bias Current	I _{OUT2} = 5mA, ENABLE ₁ = 0V, V _{CC} = 14V I _Q = I _{CC} - I _{OUT2}			7	mA
Quiescent Bias Current	I _{OUT2} = 250mA, ENABLE ₁ = 0V, V _{CC} = 14V I _Q = I _{CC} - I _{OUT2}			8	mA
Ripple Rejection	f = 120Hz, V _{CC} = 14V with 1.0 V _{PP} AC, C _{OUT} = 0μF		90		dB
	f = 10kHz, V _{CC} = 14V with 1.0V _{PP} AC, C _{OUT} = 0μF		75		dB
	f = 20kHz, V _{CC} = 14V with 1.0V _{PP} AC, C _{OUT} = 0μF		67		dB

Electrical Characteristics: $-40^{\circ}\text{C} \leq T_A \leq +85^{\circ}\text{C}$, $10.5\text{V} \leq V_{\text{CC}} \leq 16.0\text{V}$, $\text{ENABLE}_1 = \text{ENABLE}_2 = 5.0\text{V}$, $I_{\text{OUT1}} = I_{\text{OUT2}} = 5.0\text{mA}$, unless otherwise stated.

PARAMETER	TEST CONDITIONS	MIN	TYP	MAX	UNIT
■ Secondary Output (V_{OUT2}): continued					
Current Limit	$V_{\text{CC}} = 16\text{V}$	270		600	mA
Overshoot Voltage	$5\text{mA} \leq I_{\text{REG2}} \leq 250\text{mA}$			4.3	V
Output Noise	10Hz-100kHz		170		μV_{rms}

■ ENABLE Function (ENABLE)					
Input Current	$V_{\text{CC}} = 14\text{V}$, $0\text{V} \leq \text{ENABLE} \leq 5.5\text{V}$	-150		150	μA
Input Voltage	Low	0		0.8	V
	High	2.0		5.0	V

■ Protection Circuitry					
ESD Threshold	Human Body Model	± 2.0	± 4.0		kV
Overvoltage Shutdown		24		30	V
Thermal Shutdown	Guaranteed by Design	150	180		$^{\circ}\text{C}$
Thermal Hysteresis			30		$^{\circ}\text{C}$

Package Pin Description

PACKAGE PIN #	PIN SYMBOL	FUNCTION
7 Lead TO-220		
1	ENABLE_1	ENABLE control for the 8V, 1A output
2	ENABLE_2	ENABLE control for the 5V, 250mA output
3	V_{OUT2}	5V $\pm 5\%$, 250mA regulated output
4	Gnd	Ground
5	Sense	Sense feedback for the primary 8V output
6	V_{CC}	Supply voltage, usually from battery
7	V_{OUT1}	8V $\pm 5\%$, 1A regulated output

Typical Performance Characteristics

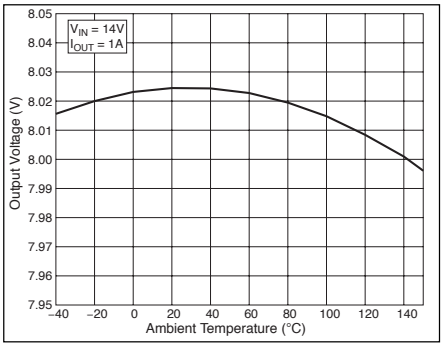

Regulator 1 Output Voltage

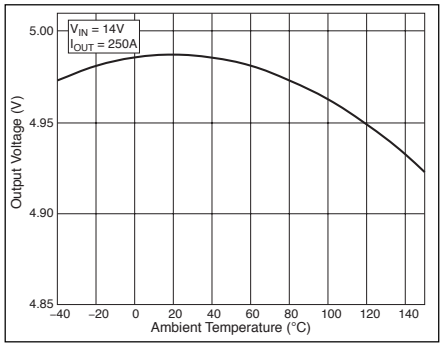

Regulator 2 Output Voltage

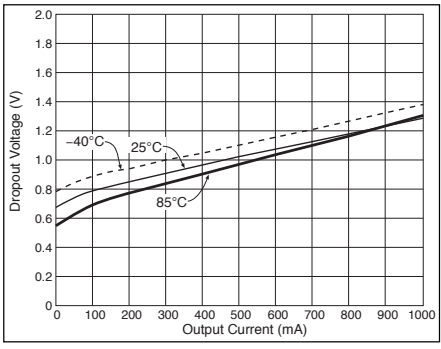

Regulator 1 Dropout Voltage

Typical Performance Characteristics: continued

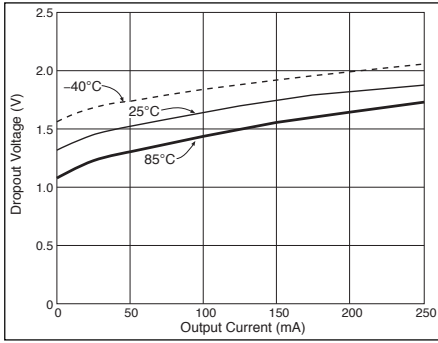

Regulator 2 Dropout Voltage

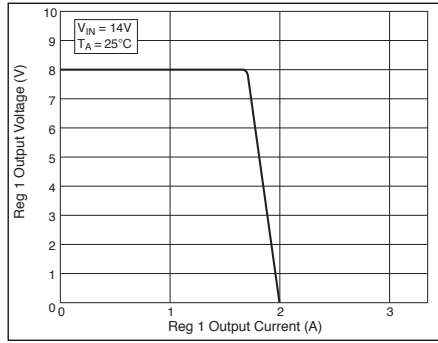

Regulator 1 Current Limit

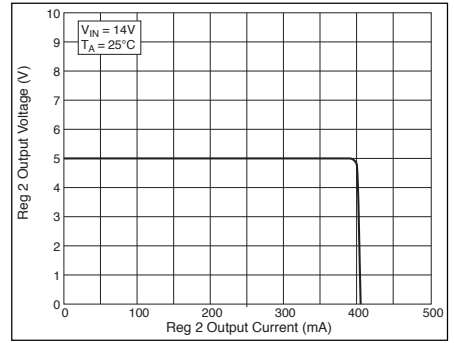

Regulator 2 Current Limit

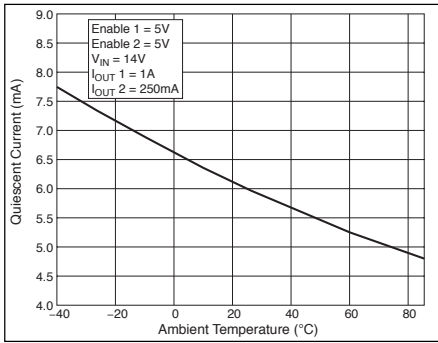

Quiescent Current

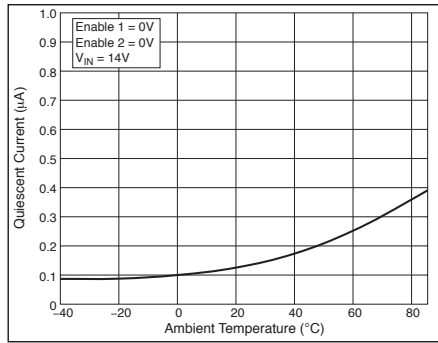

Quiescent Current

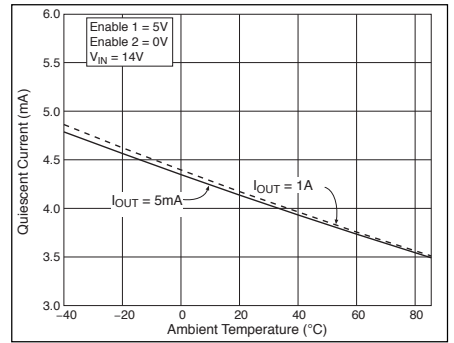

Regulator 1 Quiescent Current

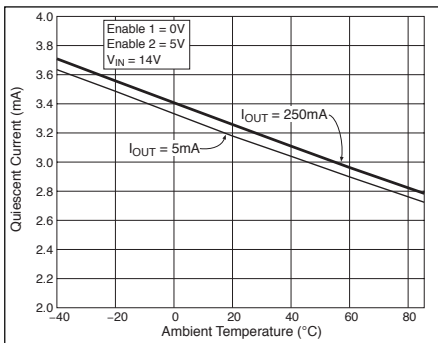

Regulator 2 Quiescent Current

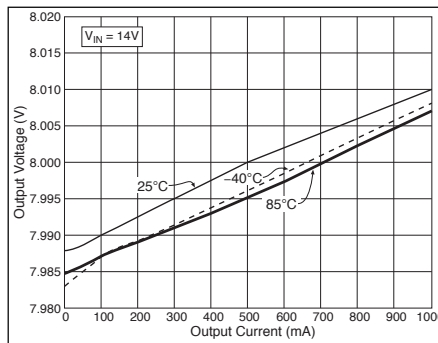

Regulator 1 Load Regulation

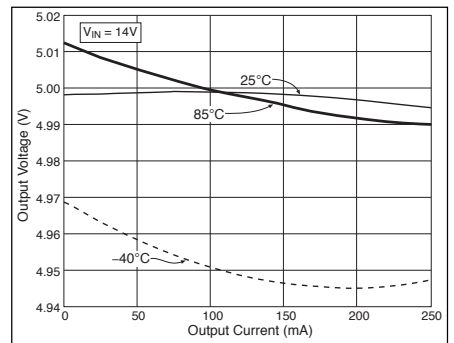

Regulator 2 Load Regulation

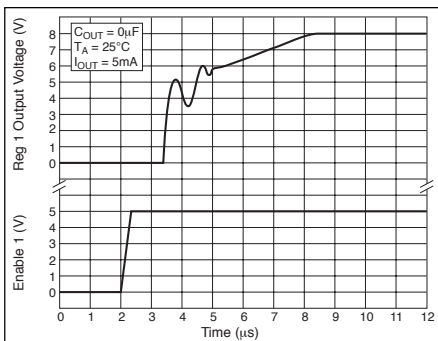

Regulator 1 Startup

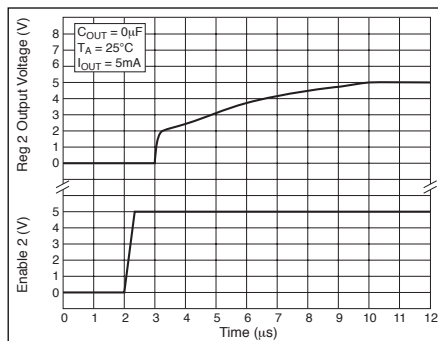

Regulator 2 Startup

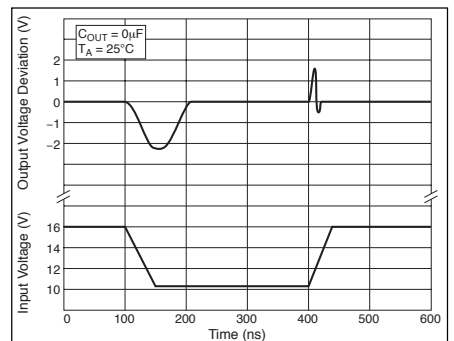

Regulator 1 Line Transient Response

Typical Performance Characteristics: continued

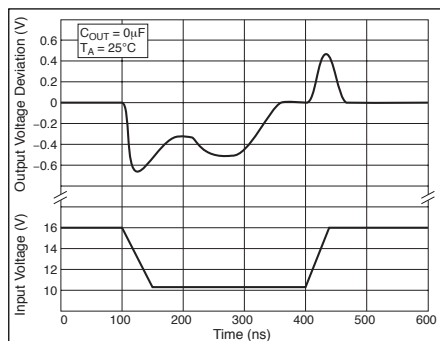

Regulator 2 Line Transient Response

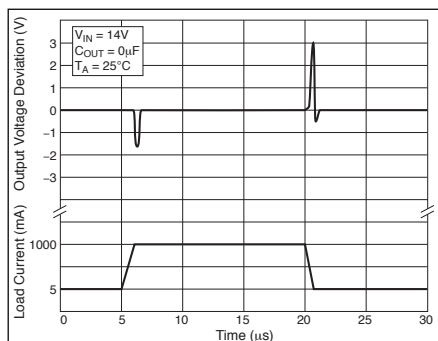

Regulator 1 Load Transient Response

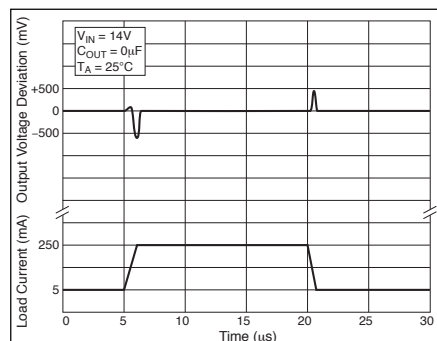

Regulator 2 Load Transient Response

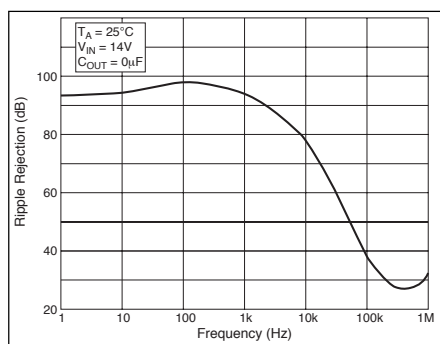

Regulator 1 Ripple Rejection

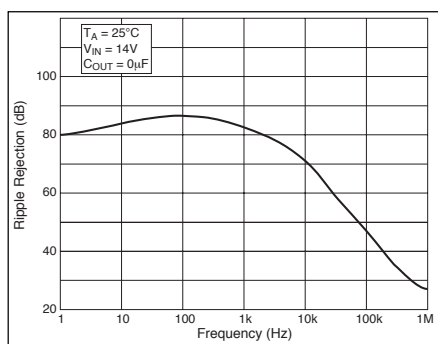

Regulator 2 Ripple Rejection

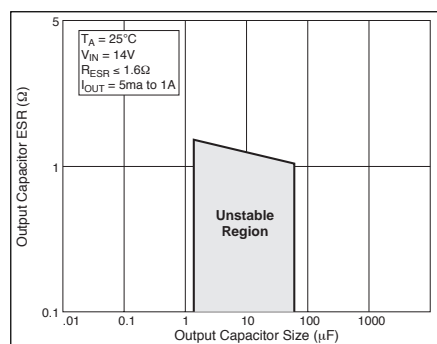

Regulator 1 Stability

Definition of Terms

Dropout Voltage: The input-output voltage differential at which the circuit ceases to regulate against further reduction in input voltage. Measured when the output voltage has dropped 100mV from the nominal value obtained at 14V input, dropout voltage is dependent upon load current and junction temperature.

Current Limit: Peak current that can be delivered to the output.

Input Voltage: The DC voltage applied to the input terminals with respect to ground.

Input Output Differential: The voltage difference between the unregulated input voltage and the regulated output voltage for which the regulator will operate.

Line Regulation: The change in output voltage for a change in the input voltage. The measurement is made under conditions of low dissipation or by using pulse techniques such that the average chip temperature is not significantly affected.

Load Regulation: The change in output voltage for a change in load current at constant chip temperature.

Long Term Stability: Output voltage stability under accelerated life-test conditions after 1000 hours with maximum rated voltage and junction temperature.

Output Noise Voltage: The rms AC voltage at the output, with constant load and no input ripple, measured over a specified frequency range.

Quiescent Current: The part of the positive input current that does not contribute to the positive load current. The regulator ground lead current.

Ripple Rejection: The ratio of the peak-to-peak input ripple voltage to the peak-to-peak output ripple voltage.

Temperature Stability of V_{OUT} : The percentage change in output voltage for a thermal variation from room temperature to either temperature extreme.

Applications Circuit

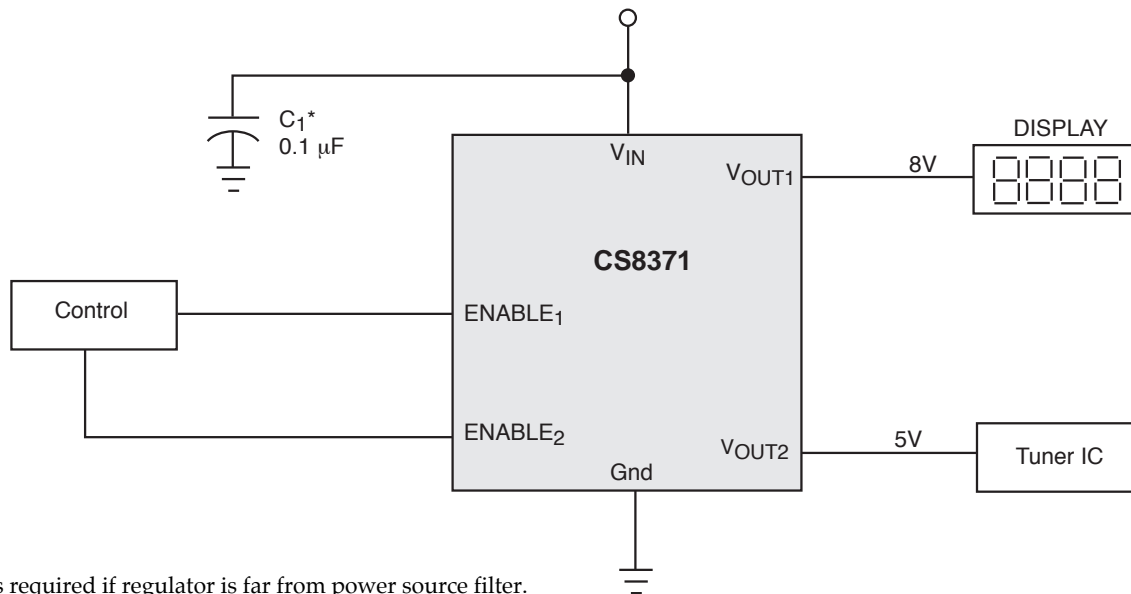

* C_1 is required if regulator is far from power source filter.

Application Notes

With separate control of each output channel, the CS8371 is ideal for applications where each load must be switched independently. In an automotive radio, the 8V output drives the displays and tape drive motors while the 5V output supplies the Tuner IC and memory.

Stability Considerations/NoCap™

Normally a low dropout or quasi-low dropout regulator (or any type requiring a slow lateral PNP in the control loop) necessitates a large external compensation capacitor at the output of the IC. The external capacitor is also used to curtail overshoot, determine startup delay time and load transient response.

Traditional LDO regulators typically have low unity gain bandwidth, display overshoot and poor ripple rejection. Compensation is also an issue because the high frequency load capacitor value, ESR (Equivalent Series Resistance) and board layout parasitics all can create oscillations if not properly accounted for.

NoCap™ is a Cherry Semiconductor exclusive output stage which internally compensates the LDO regulator

over temperature, load and line variations without the need for an expensive external capacitor. It incorporates high gain (>80dB) and large unity gain bandwidth (>100kHz) while maintaining many of the characteristics of a single-pole amplifier (large phase margin and no overshoot).

NoCap™ is ideally suited for slow switching or steady loads. If the load displays large transient current requirements, such as with high frequency microprocessors, an output storage capacitor may be needed. Some large capacitor and small capacitor ESR values at the output may cause small signal oscillations at the output. This will depend on the load conditions. With these types of loads, a traditional output stage may be better suited for proper operation.

Output 1 employs NoCap™. Refer to the plots in the Typical Performance Characteristics section for appropriate output capacitor selections for stability if an external capacitor is required by the switching characteristics of the load. Output 2 has a Darlington NPN-type output structure and is inherently stable with any type of capacitive load or no capacitor at all.

Calculating Power Dissipation in a Dual Output Linear Regulator

The maximum power dissipation for a dual output regulator (Figure 1) is

$$P_{D(\max)} = \{V_{IN(\max)} - V_{OUT1(\min)}\}I_{OUT1(\max)} + \{V_{IN(\max)} - V_{OUT2(\min)}\}I_{OUT2(\max)} + V_{IN(\max)}I_Q \quad (1)$$

where

$V_{IN(\max)}$ is the maximum input voltage,

$V_{OUT1(\min)}$ is the minimum output voltage from V_{OUT1} ,

$V_{OUT2(\min)}$ is the minimum output voltage from V_{OUT2} ,

$I_{OUT1(\max)}$ is the maximum output current, for the application,

$I_{OUT2(\max)}$ is the maximum output current, for the application,

I_Q is the quiescent current the regulator consumes at $I_{OUT(\max)}$.

Once the value of $P_{D(\max)}$ is known, the maximum permissible value of $R\Theta_{JA}$ can be calculated:

$$R\Theta_{JA} = \frac{150^\circ\text{C} - T_A}{P_D} \quad (2)$$

The value of $R\Theta_{JA}$ can then be compared with those in the package section of the data sheet. Those packages with $R\Theta_{JA}$'s less than the calculated value in equation 2 will keep the die temperature below 150°C .

In some cases, none of the packages will be sufficient to dissipate the heat generated by the IC, and an external heatsink will be required.

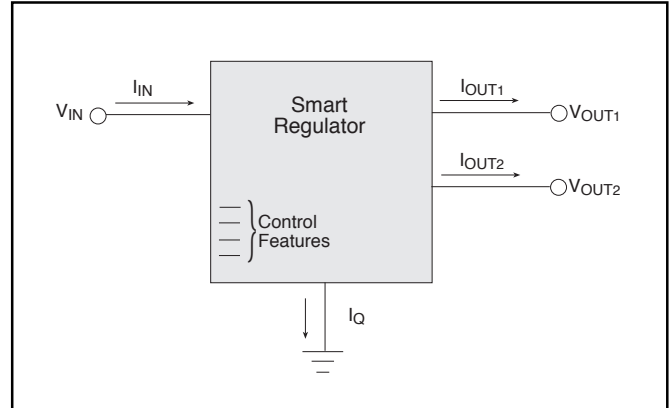

Figure 1: Dual output regulator with key performance parameters labeled.

Heatsinks

A heatsink effectively increases the surface area of the package to improve the flow of heat away from the IC and into the surrounding air.

Each material in the heat flow path between the IC and the outside environment will have a thermal resistance. Like series electrical resistances, these resistances are summed to determine the value of $R\Theta_{JA}$:

$$R\Theta_{JA} = R\Theta_{JC} + R\Theta_{CS} + R\Theta_{SA} \quad (3)$$

where

$R\Theta_{JC}$ = the junction-to-case thermal resistance,

$R\Theta_{CS}$ = the case-to-heatsink thermal resistance, and

$R\Theta_{SA}$ = the heatsink-to-ambient thermal resistance.

$R\Theta_{JC}$ appears in the package section of the data sheet. Like $R\Theta_{JA}$, it too is a function of package type. $R\Theta_{CS}$ and $R\Theta_{SA}$ are functions of the package type, heatsink and the interface between them. These values appear in heatsink data sheets of heatsink manufacturers.

Package Specification

PACKAGE DIMENSIONS IN mm (INCHES)

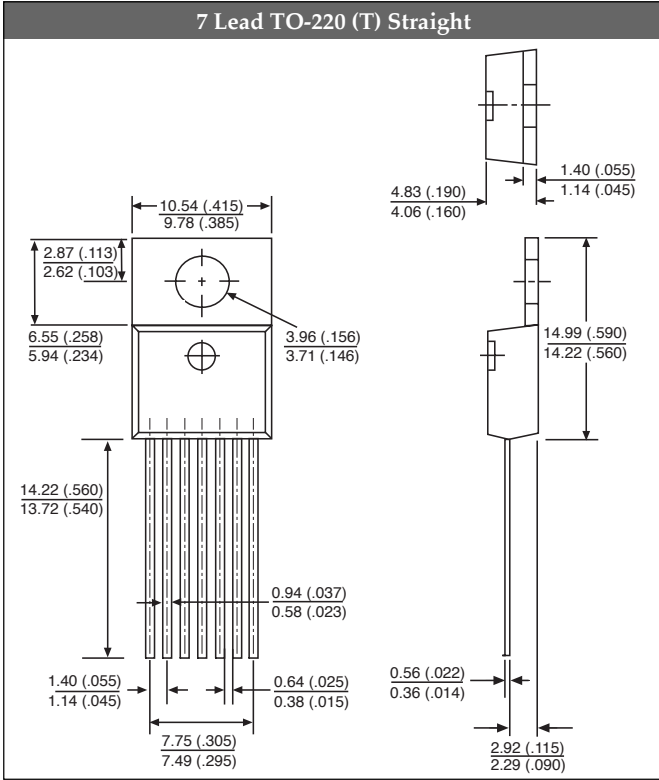

PACKAGE THERMAL DATA

Thermal Data		TO-220	
$R\theta_{JC}$	typ	2.4	$^{\circ}\text{C}/\text{W}$
$R\theta_{JA}$	typ	50	$^{\circ}\text{C}/\text{W}$

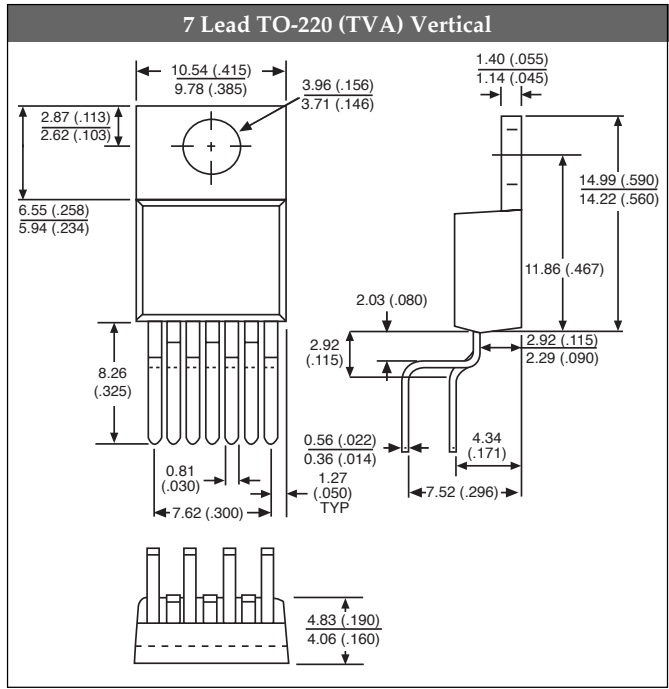

Ordering Information

Part Number	Description
CS8371ET7	7 Lead TO-220 Straight
CS8371ETVA7	7 Lead TO-220 Vertical

Cherry Semiconductor Corporation reserves the right to make changes to the specifications without notice. Please contact Cherry Semiconductor Corporation for the latest available information.