

SPECIFICATION

DEVICE NAME : Power MOSFET

TYPE NAME : 2SJ474-01L,S

SPEC. NO. :

Fuji Electric Co.,Ltd.

This Specification is subject to change without notice.



DATE	NAME	APPROVED	Fuji Electric Co.,Ltd.
DRAWN			
CHECKED			

1.Scope This specifies Fuji Power MOSFET 2SJ474-01L,S

2.Construction P-Channel enhancement mode power MOSFET

3.Applications for Switching

4.Outview T-Pack L-Type : Outview See to 5/13 page
S-Type : Outview See to 6/13 page

5.Absolute Maximum Ratings at Tc=25°C (unless otherwise specified)

Description	Symbol	Characteristics	Unit	Remarks
Drain-Source Voltage	V _{DS}	-60	V	
Continuous Drain Current	I _D	±7	A	
Pulsed Drain Current	I _{DP}	±28	A	
Gate-Source Voltage	V _{GS}	±20	V	
Maximum Avalanche Energy	E _{AV}	110.8	mJ	*1
Maximum Power Dissipation	P _D	20	W	
Operating and Storage	T _{ch}	150	°C	
Temperature range	T _{stg}	-55 to +150	°C	

*1 L=3.02mH, Vcc=-24V

6.Electrical Characteristics at Tc=25°C (unless otherwise specified)

Static Ratings

Description	Symbol	Conditions	min.	typ.	max.	Unit	
Drain-Source Breakdown Voltage	BV _{DSS}	I _D =-1mA V _{GS} =0V	-60			V	
Gate Threshold Voltage	V _{GS(th)}	I _D =-1mA V _{DS} =V _{GS}	-1.0	-1.5	-2.5	V	
Zero Gate Voltage Drain Current	I _{DSS}	V _{DS} =-60V T _{ch} =25°C		-10	-500	μA	
		V _{GS} =0V T _{ch} =125°C		-0.2	-1.0	mA	
Gate-Source Leakage Current	I _{GSS}	V _{GS} =±20V V _{DS} =0V		10	100	nA	
Drain-Source On-State Resistance	R _{DS(on)}	I _D =-3.5A	V _{GS} =-4V		260	350	mΩ
			V _{GS} =-10V		150	200	

Dynamic Ratings

Description	Symbol	Conditions	min.	typ.	max.	Unit
Forward Transconductance	g_{fs}	$I_D = -3.5A$ $V_{DS} = -25V$	2.5	5.0		S
Input Capacitance	C_{iss}	$V_{DS} = -25V$ $V_{GS} = 0V$ $f = 1MHz$		550	830	pF
Output Capacitance	C_{oss}			200	300	
Reverse Transfer Capacitance	C_{rss}			110	170	
Turn-On Time	$t_{d(on)}$	$V_{cc} = -30V$		10	15	ns
	t_r	$V_{GS} = -10V$		20	30	
Turn-Off Time	$t_{d(off)}$	$I_D = -7A$		60	90	
	t_f	$R_{GS} = 10\Omega$		25	50	

Reverse Diode

Description	Symbol	Conditions	min.	typ.	max.	Unit
Avalanche Capability	I_{AV}	$L = 100\mu H$ $T_{ch} = 25^\circ C$ See Fig.1 and Fig.2	-7			A
Diode Forward On-Voltage	V_{SD}	$I_F = 2 \times I_{DR}$ $V_{GS} = 0V$ $T_{ch} = 25^\circ C$		-2.5	-3.8	V
Reverse Recovery Time	t_{rr}	$I_F = I_{DR}$ $di/dt = 100A/\mu s$ $T_{ch} = 25^\circ C$		110		ns
Reverse Recovery Charge	Q_{rr}				0.5	

7. Thermal Resistance

Description	Symbol	min.	typ.	max.	Unit
Channel to Case	$R_{th(ch-c)}$			6.25	$^\circ C/W$
Channel to Ambient	$R_{th(ch-a)}$			125	$^\circ C/W$

Fig.1 Test circuit

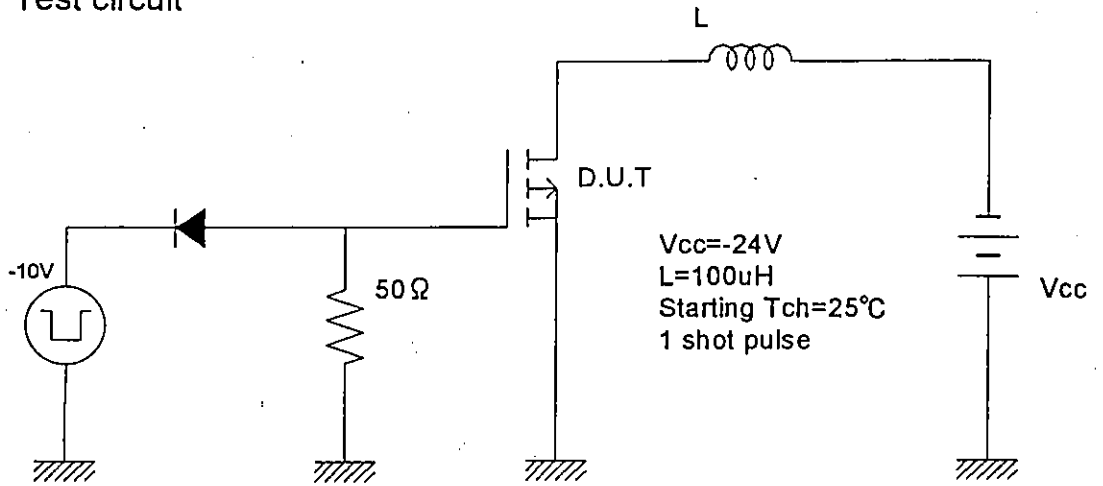
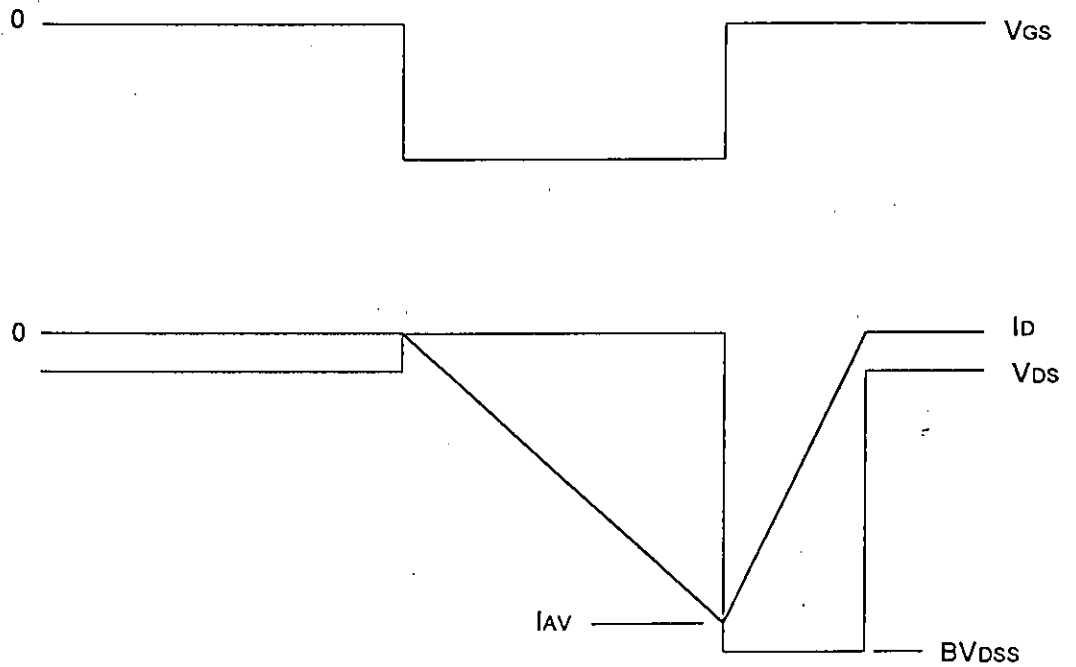
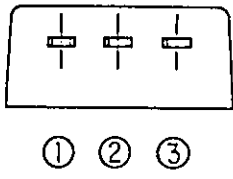
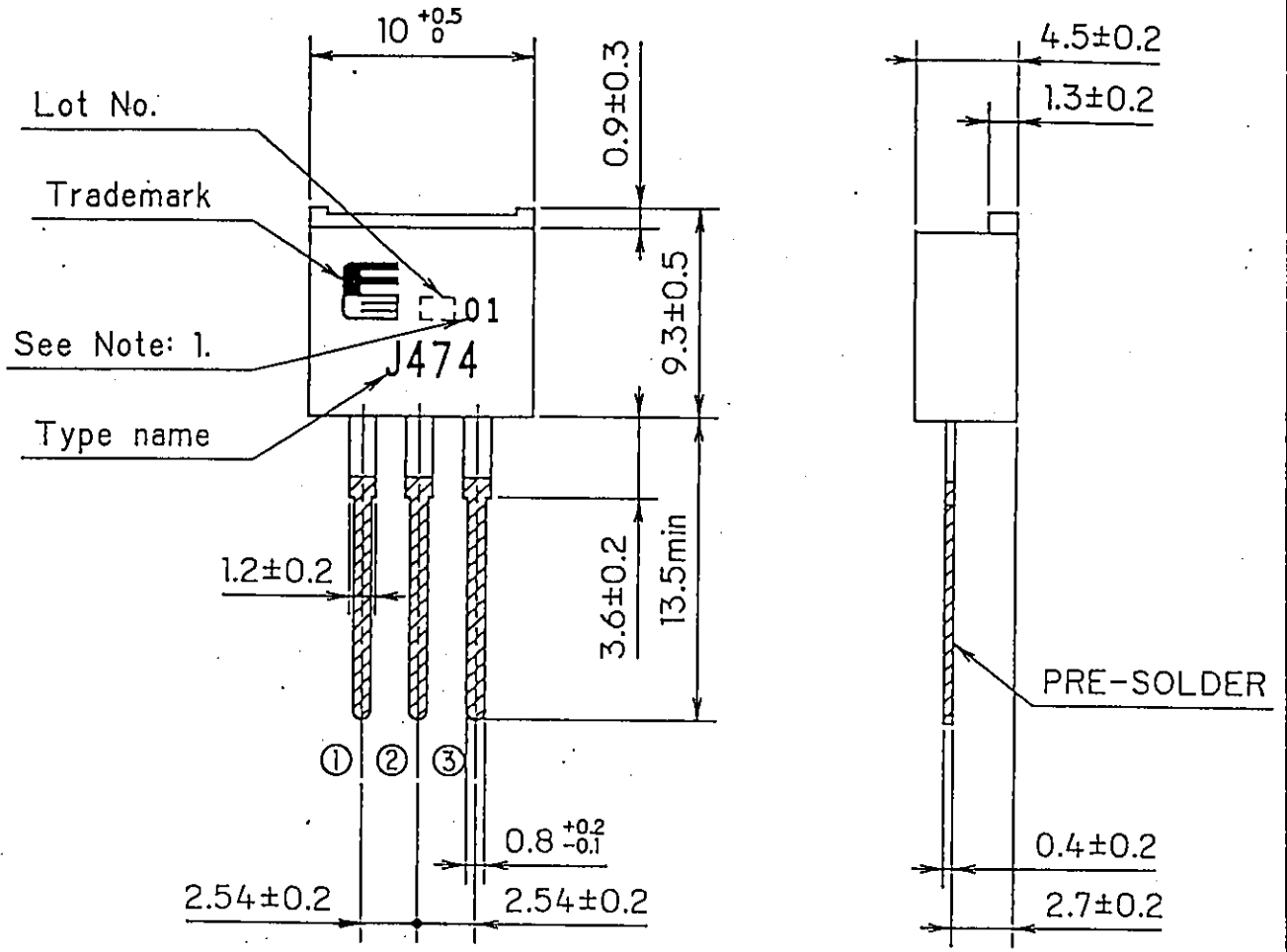

Fig.2 Operating waveforms



FUJI POWER MOS FET

TYPE : 2SJ474-01L



CONNECTION

- ① GATE
- ② DRAIN
- ③ SOURCE

Note: 1. Guaranteed mark of avalanche ruggedness.

DIMENSIONS ARE IN MILLIMETERS.

FUJI POWER MOS FET

TYPE : 2SJ474-01S

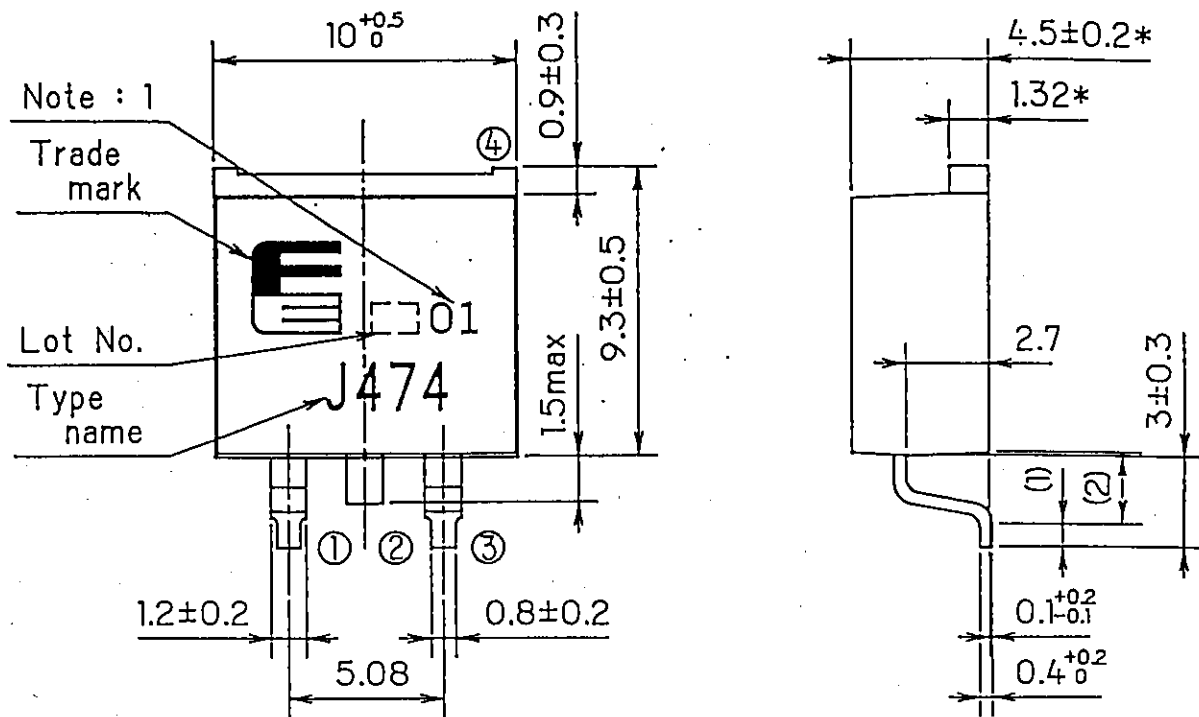

BOTTOM VIEW

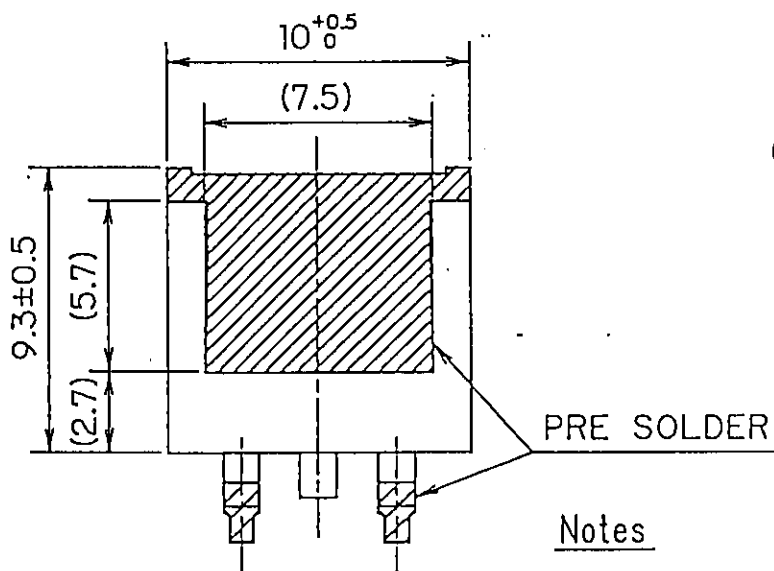

CONNECTION

- ① GATE
- ④ ② DRAIN
- ③ SOURCE

Notes

1. () : REFERENCE DIMENSIONS.
 2. * : DO NOT INCLUDE SOLDER.
- Note 1. Guaranteed mark of avalanche ruggedness.

DIMENSIONS ARE IN MILLIMETERS.

Power Dissipation
 $PD=f(T_c)$

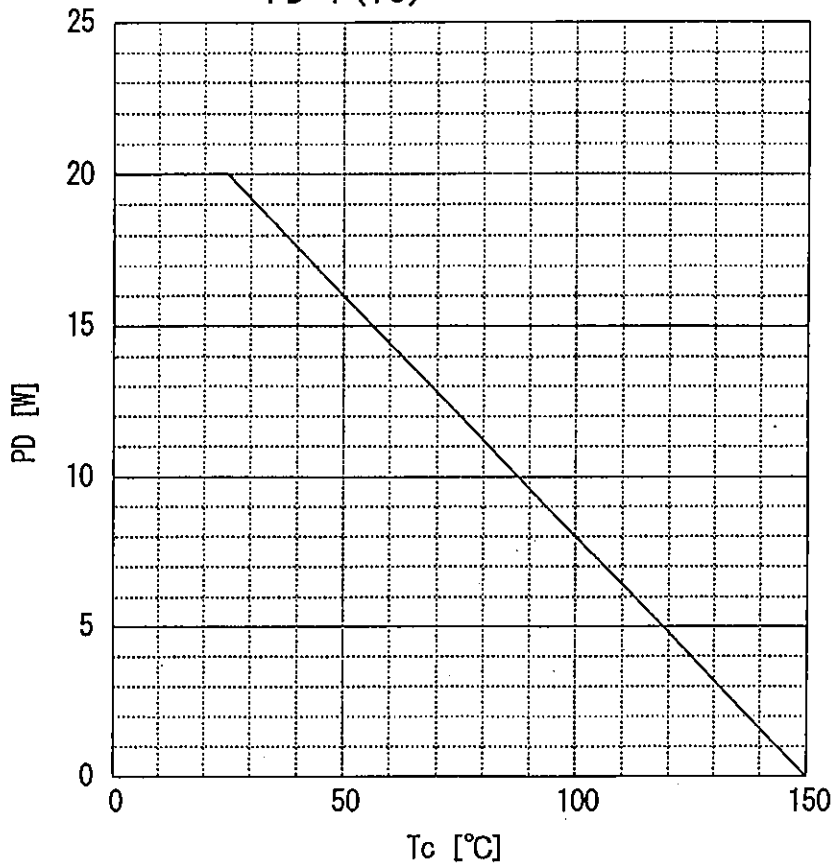

Safe operating area
 $ID=f(V_{DS}) : D=0.01, T_c=25^\circ\text{C}$

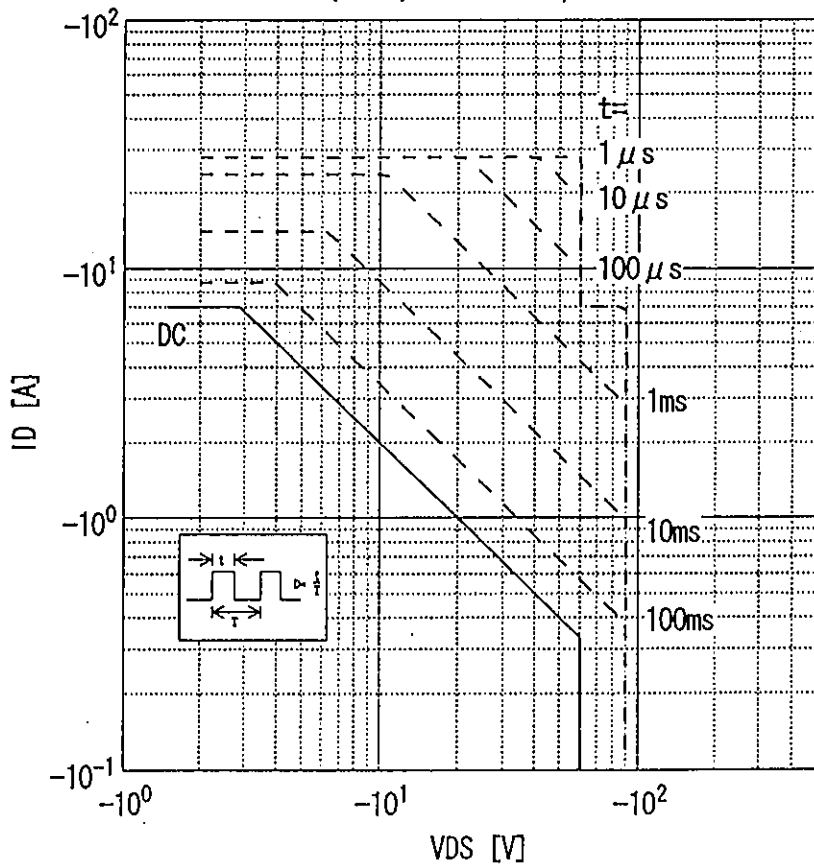

Typical output characteristics
 $I_D = f(V_{DS})$: 80 μ s pulse test, $T_c = 25^\circ\text{C}$

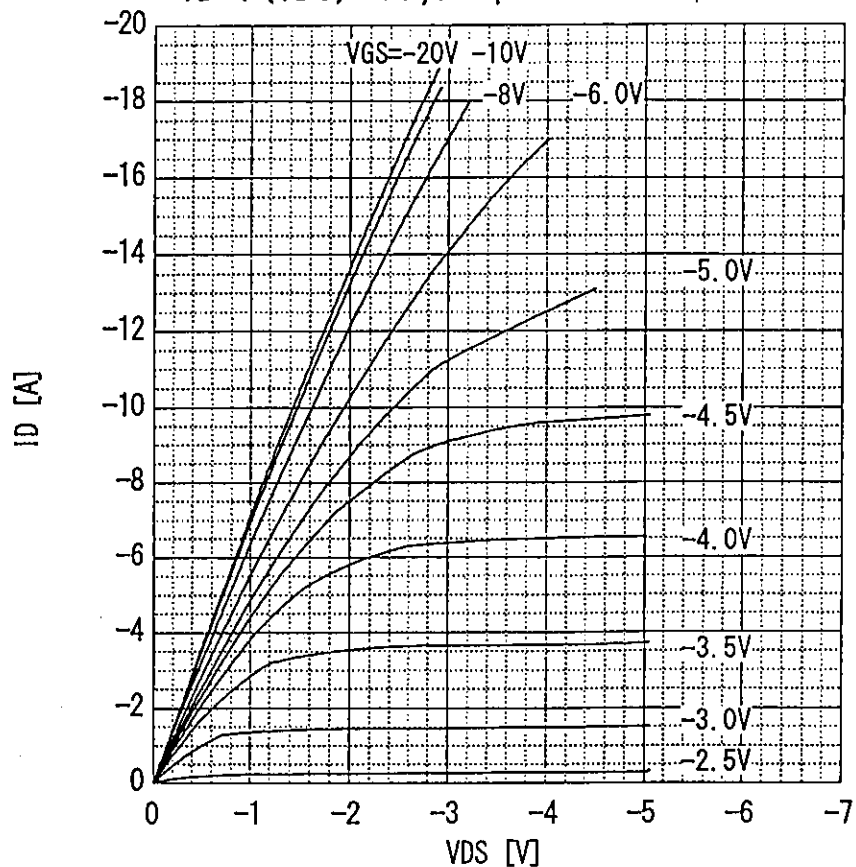

Typical transfer characteristic
 $I_D = f(V_{GS})$: 80 μ s pulse test, $V_{DS} = -25V$, $T_{ch} = 25^\circ\text{C}$

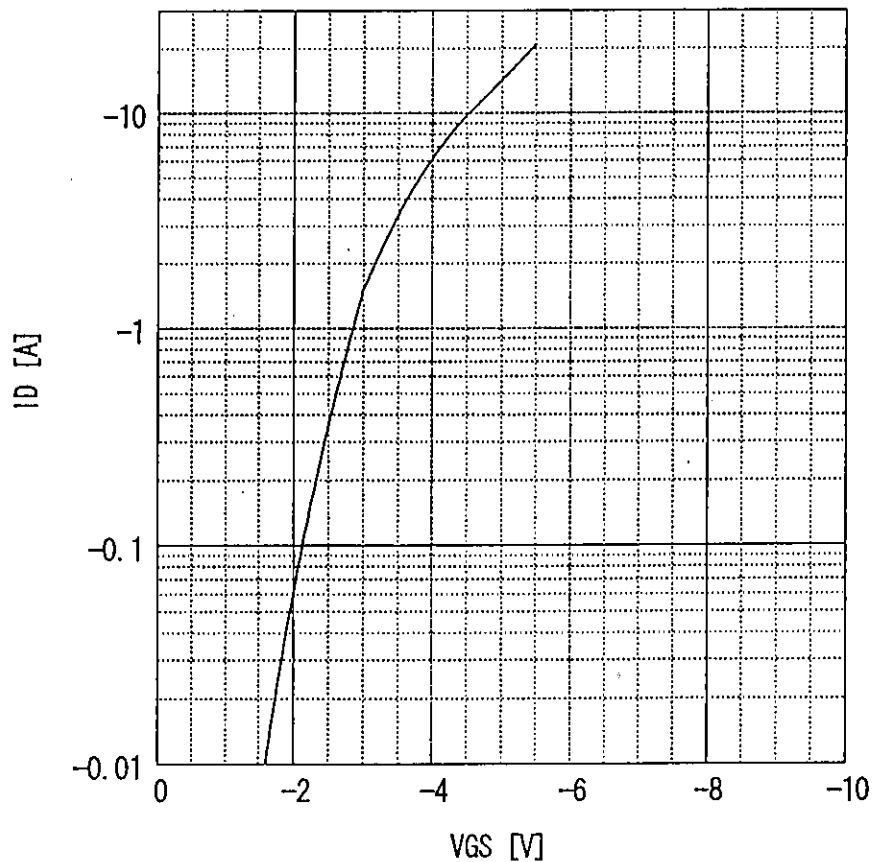

Typical forward transconductance

$g_{fs} = f(I_D)$: 80 μ s pulse test, $V_{DS} = -25V$, $T_{ch} = 25^\circ C$

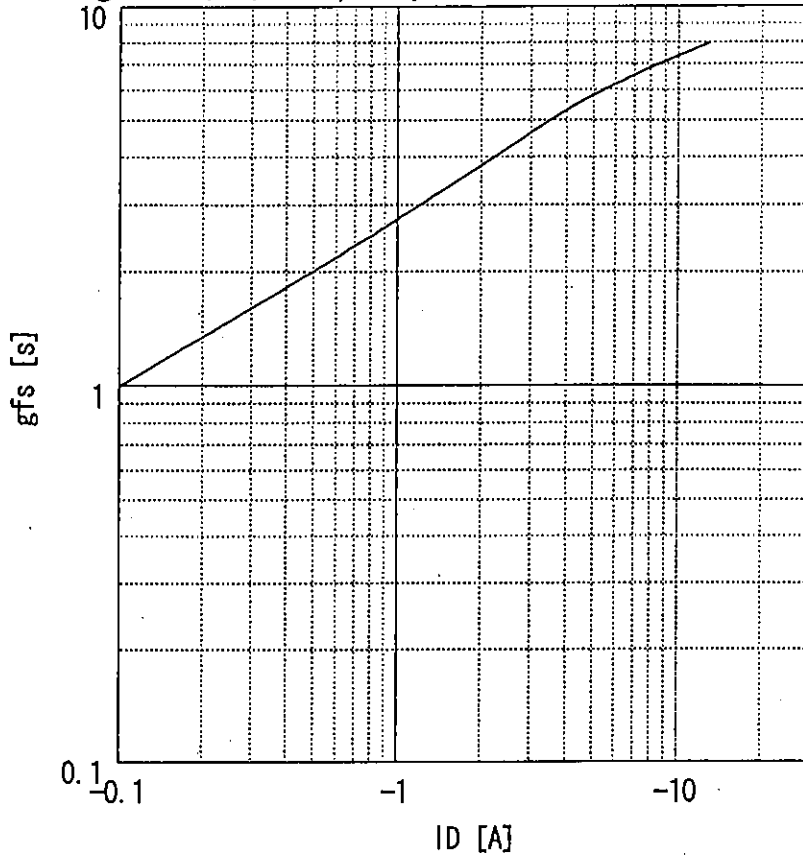

Typical drain-source on-state resistance

$R_{DS(on)} = f(I_D)$: 80 μ s pulse test, $T_c = 25^\circ C$

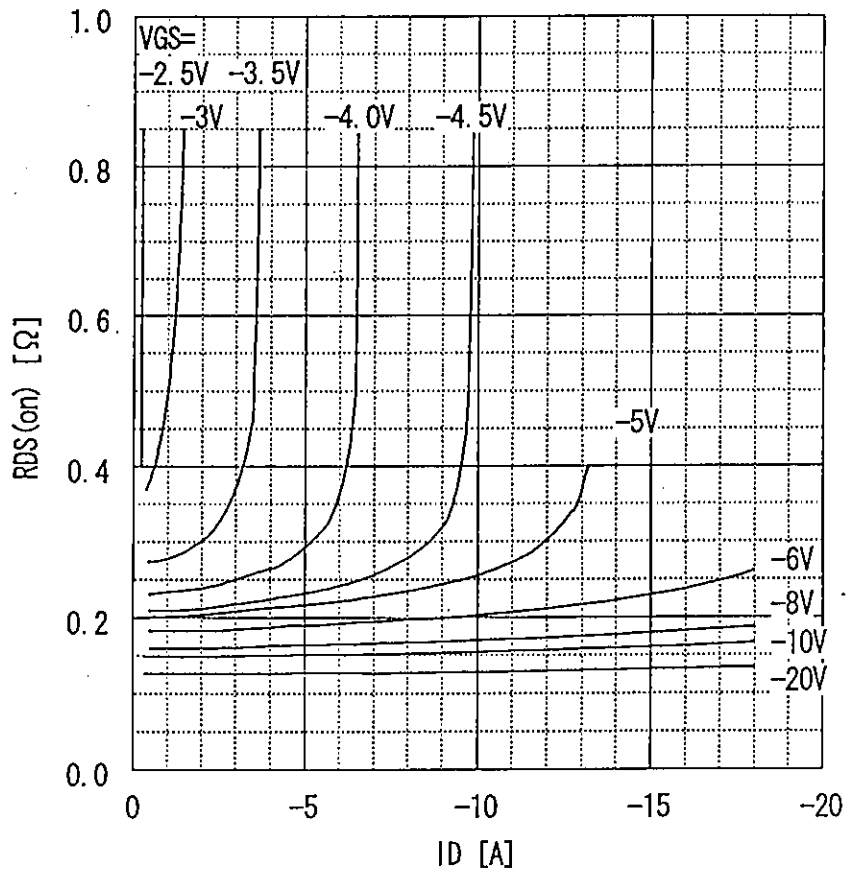

Drain-source on-state resistance
 $R_{DS(on)} = f(T_{ch}) : I_D = -3.5A, V_{GS} = 10V$

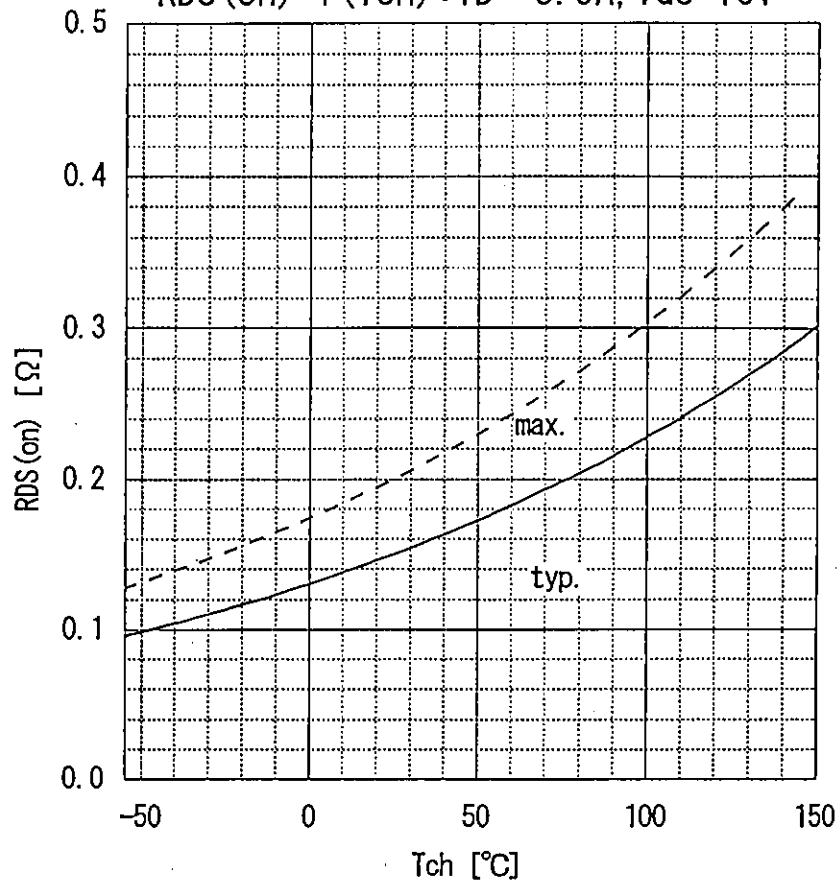

Gate threshold voltage
 $V_{GS(th)} = f(T_{ch}) : I_D = -1mA, V_{DS} = V_{GS}$

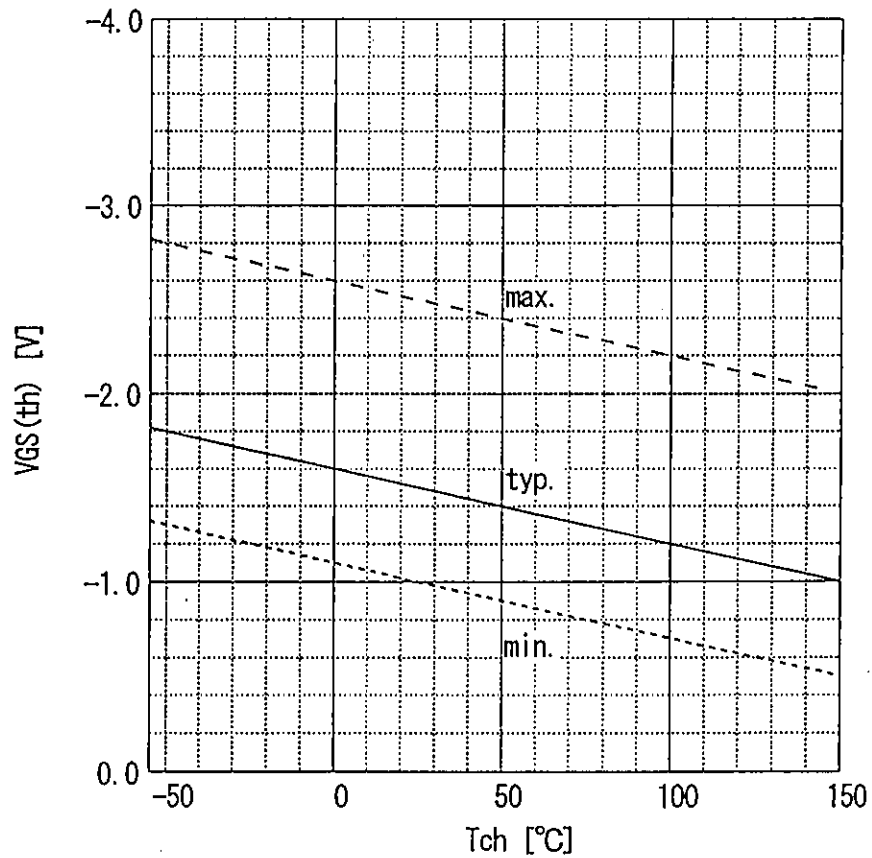

Typical gate charge characteristic
 $V_{GS} = f(Q_g) : I_D = -7A, T_c = 25^\circ C$

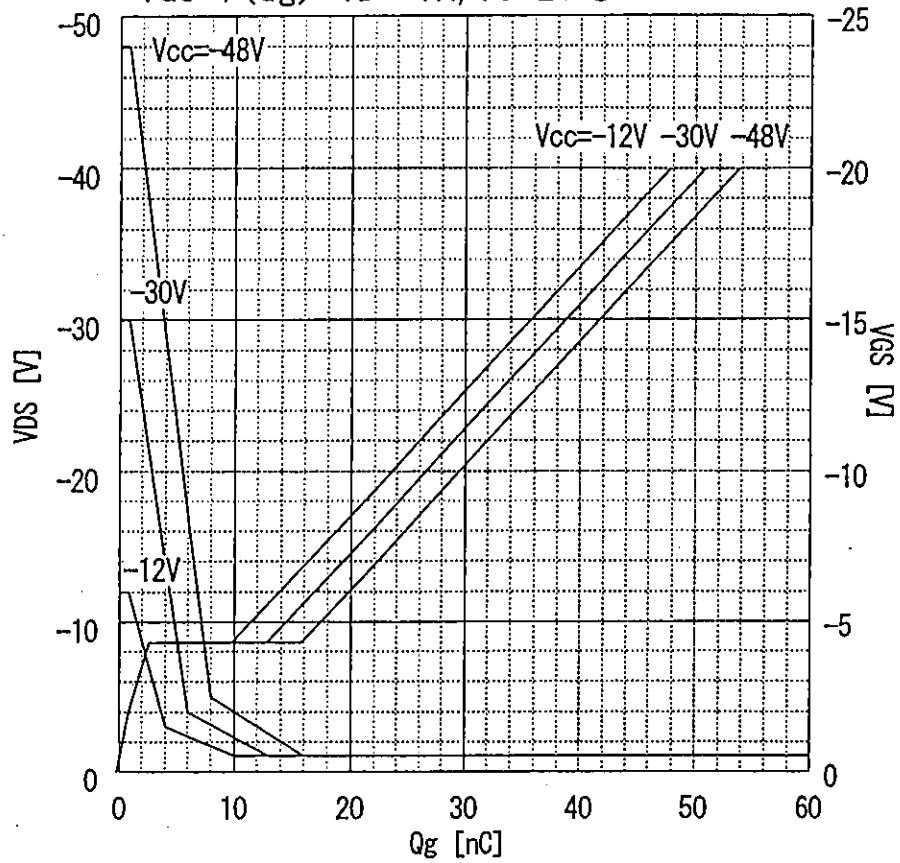

Typical capacitances
 $C = f(V_{DS}) : V_{GS} = 0V, f = 1MHz$

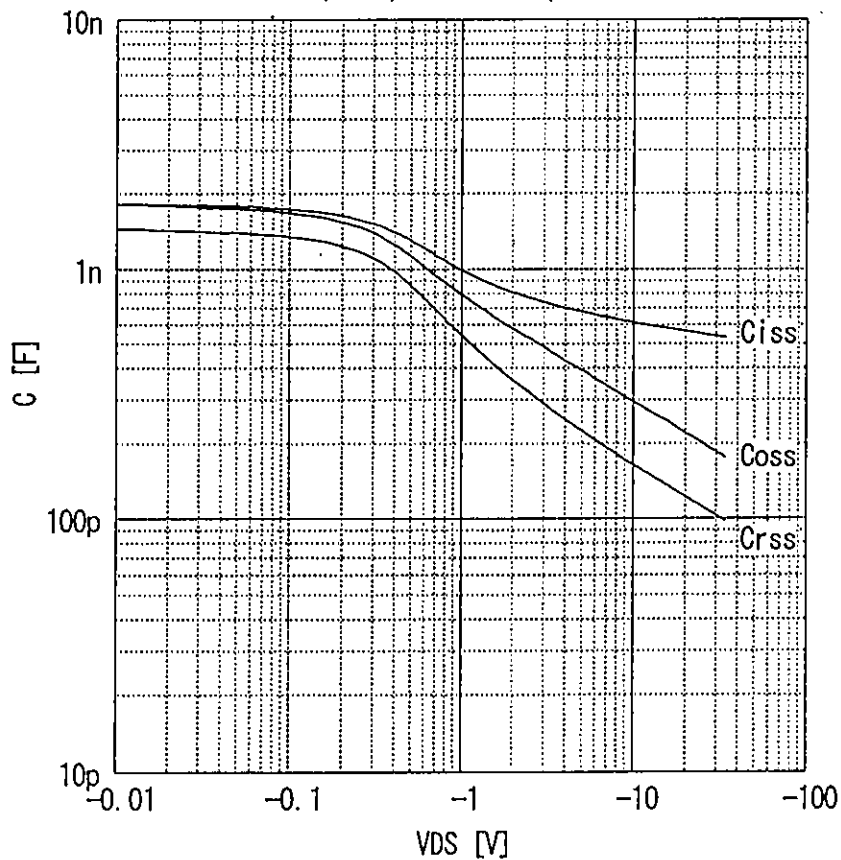

Maximum Avalanche Current vs. starting Tch
 $I(AV) = f(\text{starting Tch})$

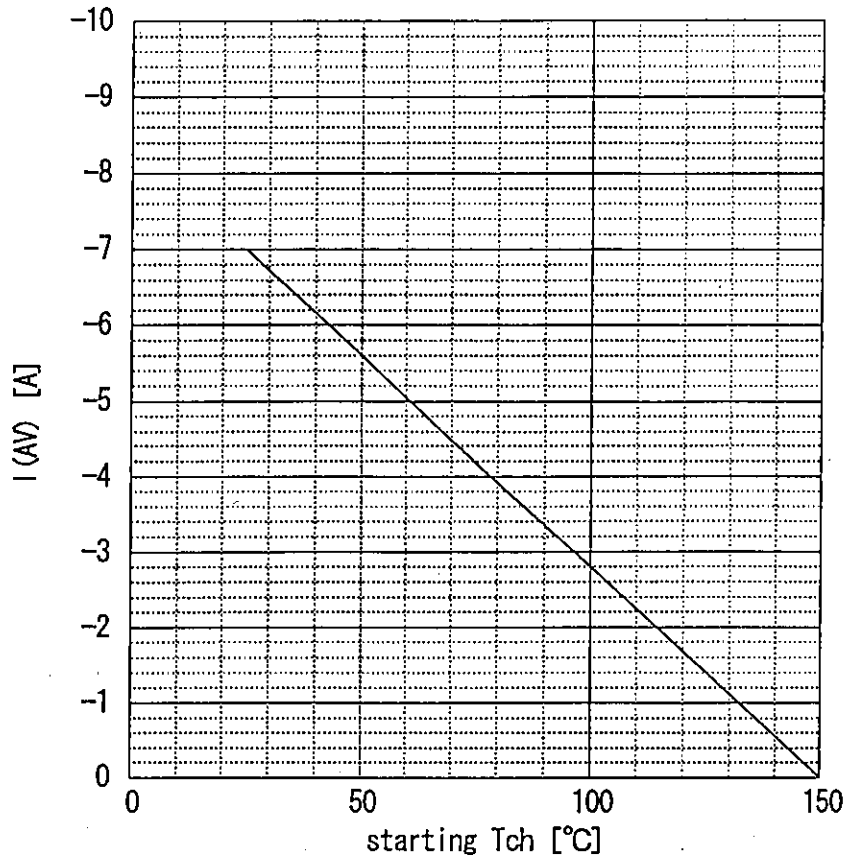

Maximum Avalanche Energy vs. starting Tch
 $E(AV) = f(\text{starting Tch}) : V_{CC} = -24V, I(AV) \geq -7A$

