



CD4067BMS CD4097BMS

CMOS Analog Multiplexers/Demultiplexers

December 1992

Features

- High Voltage Types (20V Rating)
- CD4067BMS Single 16 Channel Multiplexer/Demultiplexer
- CD4097BMS Differential 8 Channel Multiplexer/Demultiplexer
- Low ON Resistance: 125Ω (typ) Over 15Vp-p Signal Input Range for VDD - VSS = 15V
- High OFF Resistance: Channel Leakage of ±10pA (typ) at VDD - VSS = 18V
- Matched Switch Characteristics: RON = 5Ω (typ) for VDD - VSS = 15V
- Very Low Quiescent Power Dissipation Under All Digital Control Input and Supply Conditions: 0.2μW (typ) at VDD - VSS = 10V
- Binary Address Decoding on Chip
- 5V, 10V and 15V Parametric Ratings
- 100% Tested for Quiescent Current at 20V
- Maximum Input Current of 1μA at 18V Over Full Package Temperature Range; 100nA at 18V and +25°C
- Standardized Symmetrical Output Characteristics

Applications

- Analog and Digital Multiplexing and Demultiplexing
- A/D and D/A Conversion
- Signal Gating

* When these devices are used as demultiplexers the "CHANNEL IN/OUT" terminals are the outputs and the "COMMON OUT/IN" terminals are the inputs.

Description

CD4067BMS and CD4097BMS CMOS analog multiplexers/demultiplexers* are digitally controlled analog switches having low ON Impedance, low OFF leakage current, and internal address decoding. In addition, the ON resistance is relatively constant over the full input-signal range.

The CD4067BMS is a 16 channel multiplexer with four binary control inputs, A, B, C, D and an inhibit input, arranged so that any combination of the inputs selects one switch.

The CD4097BMS is a differential 8 channel multiplexer having three binary control inputs A, B, C and an inhibit input. The inputs permit selection of one of eight pairs of switches. A logic "1" present at the inhibit input turns all channels off.

The CD4067BMS and CD4097BMS are supplied in these 24 lead outline packages:

| | | |
|------------------|----------|------|
| Braze Seal DIP | *H4V | †H6M |
| Frit Seal DIP | *H1Z | †HFN |
| Ceramic Flatpack | *H4P | †H4P |
| *CD4067B Only | †CD4097B | |

Pinout

CD4067BMS
TOP VIEW

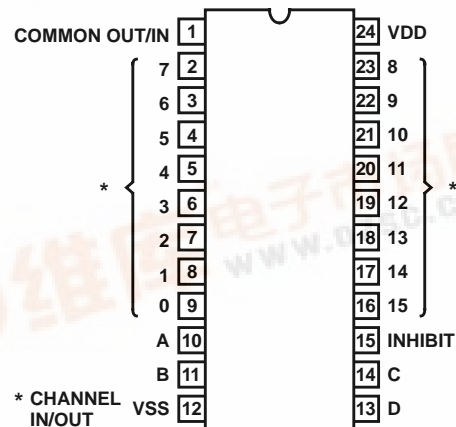

CD4097BMS
TOP VIEW

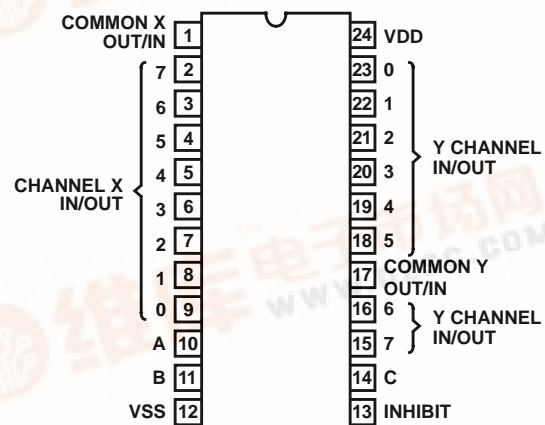

Specifications CD4067BMS, CD4097BMS

Absolute Maximum Ratings

DC Supply Voltage Range, (VDD) -0.5V to +20V
 (Voltage Referenced to VSS Terminals)
 Input Voltage Range, All Inputs -0.5V to VDD +0.5V
 DC Input Current, Any One Input ±10mA
 Operating Temperature Range -55°C to +125°C
 Package Types D, F, K, H
 Storage Temperature Range (TSTG) -65°C to +150°C
 Lead Temperature (During Soldering) +265°C
 At Distance 1/16 ± 1/32 Inch (1.59mm ± 0.79mm) from case for
 10s Maximum

Reliability Information

Thermal Resistance θ_{ja} θ_{jc}
 Ceramic DIP and FRIT Package 80°C/W 20°C/W
 Flatpack Package 70°C/W 20°C/W
 Maximum Package Power Dissipation (PD) at +125°C
 For TA = -55°C to +100°C (Package Type D, F, K) 500mW
 For TA = +100°C to +125°C (Package Type D, F, K) Derate
 Linearity at 12mW/°C to 200mW
 Device Dissipation per Output Transistor 100mW
 For TA = Full Package Temperature Range (All Package Types)
 Junction Temperature +175°C

TABLE 1. DC ELECTRICAL PERFORMANCE CHARACTERISTICS

| PARAMETER | SYMBOL | CONDITIONS (NOTE 1) | | GROUP A SUBGROUPS | TEMPERATURE | LIMITS | | UNITS |
|--|--------|--|----------|----------------------|----------------------|----------------|----------------|-------|
| | | | | | | MIN | MAX | |
| Supply Current | IDD | VDD = 20V, VIN = VDD or GND | | 1 | +25°C | - | 10 | μA |
| | | | | 2 | +125°C | - | 1000 | μA |
| | | VDD = 18V, VIN = VDD or GND | | 3 | -55°C | - | 10 | μA |
| Input Leakage Current | IIL | VIN = VDD or GND | VDD = 20 | 1 | +25°C | -100 | - | nA |
| | | | | 2 | +125°C | -1000 | - | nA |
| | | VDD = 18V | | 3 | -55°C | -100 | - | nA |
| Input Leakage Current | IIH | VIN = VDD or GND | VDD = 20 | 1 | +25°C | - | 100 | nA |
| | | | | 2 | +125°C | - | 1000 | nA |
| | | VDD = 18V | | 3 | -55°C | - | 100 | nA |
| ON-State Resistance RL = 10K Returned to VDD - VSS/2 | RON | VDD = 5V VIS = VSS to VDD | | 1 | +25°C | - | 1050 | Ω |
| | | | | 2 | +125°C | - | 1300 | Ω |
| | | | | 3 | -55°C | - | 800 | Ω |
| | | VDD = 10V VIS = VSS to VDD | | 1 | +25°C | - | 400 | Ω |
| | | | | 2 | +125°C | - | 500 | Ω |
| | | | | 3 | -55°C | - | 310 | Ω |
| | | VDD = 15V VIS = VSS to VDD | | 1 | +25°C | - | 240 | Ω |
| | | | | 2 | +125°C | - | 320 | Ω |
| | | | | 3 | -55°C | - | 220 | Ω |
| N Threshold Voltage | VNTH | VDD = 10V, ISS = -10μA | | 1 | +25°C | -2.8 | -0.7 | V |
| P Threshold Voltage | VPTH | VSS = 0V, IDD = 10μA | | 1 | +25°C | 0.7 | 2.8 | V |
| Functional (Note 4) | F | VDD = 2.8V, VIN = VDD or GND | | 7 | +25°C | VOH > VDD/2 | VOL < VDD/2 | V |
| | | VDD = 20V, VIN = VDD or GND | | 7 | +25°C | | | |
| | | VDD = 18V, VIN = VDD or GND | | 8A | +125°C | | | |
| | | VDD = 3V, VIN = VDD or GND | | 8B | -55°C | | | |
| Input Voltage Low (Note 2) | VIL | VDD = 5V = VIS Thru 1K VEE = VSS | | 1, 2, 3 | +25°C, +125°C, -55°C | - | 1.5 | V |
| Input Voltage High (Note 2) | VIH | RL = 1K to VSS ISS < 2μA on all OFF Channels | | 1, 2, 3 | +25°C, +125°C, -55°C | 3.5 | - | V |
| Input Voltage Low (Note 2) | VIL | VDD = 15V = VIS Thru 1K VEE = VSS | | 1, 2, 3 | +25°C, +125°C, -55°C | - | 4 | V |
| Input Voltage High (Note 2) | VIH | RL = 1K to VSS ISS < 2μA on all OFF Channels | | 1, 2, 3 | +25°C, +125°C, -55°C | 11 | - | V |

Specifications CD4067BMS, CD4097BMS

TABLE 1. DC ELECTRICAL PERFORMANCE CHARACTERISTICS

| PARAMETER | SYMBOL | CONDITIONS (NOTE 1) | | GROUP A SUBGROUPS | TEMPERATURE | LIMITS | | UNITS |
|--|--------|---------------------|-----------|-------------------|-------------|--------|-----|-------|
| | | | | | | MIN | MAX | |
| OFF Channel Leakage Any Channel OFF or All Channels OFF (Common OUT/IN) | IOZL | VOUT = 0V | VDD = 20V | 1 | +25°C | -0.1 | - | μA |
| | | | | 2 | +125°C | -1.0 | - | μA |
| | | | | 3 | -55°C | -0.1 | - | μA |
| | IOZH | VOUT = VDD | VDD = 20V | 1 | +25°C | - | 0.1 | μA |
| | | | | 2 | +125°C | - | 1.0 | μA |
| | | | | 3 | -55°C | - | 0.1 | μA |

- NOTES: 1. All voltages referenced to device GND, 100% testing being implemented.
 2. Go/No Go test with limits applied to inputs.
 3. For accuracy, voltage is measured differentially to VDD. Limit is 0.050V max.
 4. VDD = 2.8/3.0V, RL = 200K
 VDD = 20V/18V, RL = 10K - 25K

TABLE 2. AC ELECTRICAL PERFORMANCE CHARACTERISTICS

| PARAMETER | SYMBOL | CONDITIONS | GROUP A SUBGROUPS | TEMPERATURE | LIMITS | | UNITS |
|---|--------------|--|-------------------|---------------|--------|-----|-------|
| | | | | | MIN | MAX | |
| Propagation Delay (Signal In to Output) | TPHL TPLH | VDD = 5V, VIN = VDD or GND (Notes 1, 2) | 9 | +25°C | - | 60 | ns |
| | | | 10, 11 | +125°C, -55°C | - | 81 | ns |
| Propagation Delay Address or Inhibit to Signal Out. (Channel Turning On) | TPZH TPZL | VDD = 5V, VIN = VDD or GND (Notes 2, 3) | 9 | +25°C | - | 650 | ns |
| | | | 10, 11 | +125°C, -55°C | - | 878 | ns |

NOTES:

- CL = 50pF, RL = 200K, Input TR, TF < 20ns.
- 55°C and +125°C limits guaranteed, 100% testing being implemented.
- CL = 50pF, RL = 10K, Input TR, TF < 20ns.

TABLE 3. ELECTRICAL PERFORMANCE CHARACTERISTICS

| PARAMETER | SYMBOL | CONDITIONS | | NOTES | TEMPERATURE | LIMITS | | UNITS |
|---|--------------|---|---------------------|---------|-------------------------|--------|-----|-------|
| | | | | | | MIN | MAX | |
| Supply Current | IDD | VDD = 5V, VIN = VDD or GND | | 1, 2 | -55°C, +25°C | - | 5 | μA |
| | | | | | +125°C | - | 150 | μA |
| | | VDD = 10V, VIN = VDD or GND | | 1, 2 | -55°C, +25°C | - | 10 | μA |
| | | | | | +125°C | - | 300 | μA |
| | | VDD = 15V, VIN = VDD or GND | | 1, 2 | -55°C, +25°C | - | 10 | μA |
| +125°C | - | | | | 600 | μA | | |
| Input Voltage Low | VIL | VDD = VIS = 10V VEE = VSS | | 1, 2 | +25°C, +125°C, -55°C | - | 3 | V |
| Input Voltage High | VIH | RL = 1K to VSS IIS < 2μA ON OFF Channel | | 1, 2 | +25°C, +125°C, -55°C | +7 | - | V |
| Propagation Delay Address or Inhibit to Signal Out. (Channel Turning On) | TPZH TPZL | VDD = 10V | | 1, 2, 4 | +25°C | - | 270 | ns |
| | | VDD = 15V | | 1, 2, 4 | +25°C | - | 190 | ns |
| Propagation Delay Signal In to Output | TPHL TPLH | VDD = 10V | VIS = VDD or GND | 1, 2, 3 | +25°C | - | 30 | ns |
| | | VDD = 15V | | | +25°C | - | 20 | ns |

Specifications CD4067BMS, CD4097BMS

TABLE 3. ELECTRICAL PERFORMANCE CHARACTERISTICS (Continued)

| PARAMETER | SYMBOL | CONDITIONS | NOTES | TEMPERATURE | LIMITS | | UNITS |
|--|--------------|------------------------|---------|-------------|--------|-----|-------|
| | | | | | MIN | MAX | |
| Propagation Delay Address or Inhibit to Signal Out (Channel Turning Off) | TPHZ TPLZ | VDD = 5V | 1, 2, 5 | +25°C | - | 440 | ns |
| | | VDD = 10V | 1, 2, 5 | +25°C | - | 180 | ns |
| | | VDD = 15V | 1, 2, 5 | +25°C | - | 130 | ns |
| Input Capacitance | CIN | Any Address or Inhibit | 1, 2 | +25°C | - | 7.5 | pF |

NOTES:

1. All voltages referenced to device GND.
2. The parameters listed on Table 3 are controlled via design or process and are not directly tested. These parameters are characterized on initial design release and upon design changes which would affect these characteristics.
3. CL = 50pF, RL = 200K, Input TR, TF < 20ns.
4. CL = 50pF, RL = 10K, Input TR, TF < 20ns.
5. CL = 50pF, RL = 300Ω, Input TR, TF < 20ns.

TABLE 4. POST IRRADIATION ELECTRICAL PERFORMANCE CHARACTERISTICS

| PARAMETER | SYMBOL | CONDITIONS | NOTES | TEMPERATURE | LIMITS | | UNITS |
|---------------------------|--------------|-----------------------------|------------|-------------|-------------|--------------------|-------|
| | | | | | MIN | MAX | |
| Supply Current | IDD | VDD = 20V, VIN = VDD or GND | 1, 4 | +25°C | - | 25 | μA |
| N Threshold Voltage | VNTH | VDD = 10V, ISS = -10μA | 1, 4 | +25°C | -2.8 | -0.2 | V |
| N Threshold Voltage Delta | ΔVTN | VDD = 10V, ISS = -10μA | 1, 4 | +25°C | - | ±1 | V |
| P Threshold Voltage | VTP | VSS = 0V, IDD = 10μA | 1, 4 | +25°C | 0.2 | 2.8 | V |
| P Threshold Voltage Delta | ΔVTP | VSS = 0V, IDD = 10μA | 1, 4 | +25°C | - | ±1 | V |
| Functional | F | VDD = 18V, VIN = VDD or GND | 1 | +25°C | VOH > VDD/2 | VOL < VDD/2 | V |
| | | VDD = 3V, VIN = VDD or GND | | | | | |
| Propagation Delay Time | TPHL TPLH | VDD = 5V | 1, 2, 3, 4 | +25°C | - | 1.35 x +25°C Limit | ns |

- NOTES: 1. All voltages referenced to device GND. 2. CL = 50pF, RL = 200K, Input TR, TF < 20ns. 3. See Table 2 for +25°C limit. 4. Read and Record

TABLE 5. BURN-IN AND LIFE TEST DELTA PARAMETERS +25°C

| PARAMETER | SYMBOL | DELTA LIMIT |
|------------------------|----------|--------------------------|
| Supply Current - MSI-2 | IDD | ± 1.0μA |
| ON Resistance | RONDEL10 | ± 20% x Pre-Test Reading |

TABLE 6. APPLICABLE SUBGROUPS

| CONFORMANCE GROUP | MIL-STD-883 METHOD | GROUP A SUBGROUPS | READ AND RECORD |
|-------------------------------|--------------------|----------------------|----------------------------|
| Initial Test (Pre Burn-In) | 100% 5004 | 1, 7, 9 | IDD, IOL5, IOH5A, RONDEL10 |
| Interim Test 1 (Post Burn-In) | 100% 5004 | 1, 7, 9 | IDD, IOL5, IOH5A, RONDEL10 |
| Interim Test 2 (Post Burn-In) | 100% 5004 | 1, 7, 9 | IDD, IOL5, IOH5A, RONDEL10 |
| PDA (Note 1) | 100% 5004 | 1, 7, 9, Deltas | |
| Interim Test 3 (Post Burn-In) | 100% 5004 | 1, 7, 9 | IDD, IOL5, IOH5A, RONDEL10 |
| PDA (Note 1) | 100% 5004 | 1, 7, 9, Deltas | |
| Final Test | 100% 5004 | 2, 3, 8A, 8B, 10, 11 | |

Specifications CD4067BMS, CD4097BMS

TABLE 6. APPLICABLE SUBGROUPS

| CONFORMANCE GROUP | | MIL-STD-883 METHOD | GROUP A SUBGROUPS | READ AND RECORD |
|-------------------|--------------|--------------------|---------------------------------------|------------------------------|
| Group A | | Sample 5005 | 1, 2, 3, 7, 8A, 8B, 9, 10, 11 | |
| Group B | Subgroup B-5 | Sample 5005 | 1, 2, 3, 7, 8A, 8B, 9, 10, 11, Deltas | Subgroups 1, 2, 3, 9, 10, 11 |
| | Subgroup B-6 | Sample 5005 | 1, 7, 9 | |
| Group D | | Sample 5005 | 1, 2, 3, 8A, 8B, 9 | Subgroups 1, 2 3 |

NOTE: 1. 5% Parametric, 3% Functional; Cumulative for Static 1 and 2.

TABLE 7. TOTAL DOSE IRRADIATION

| CONFORMANCE GROUPS | MIL-STD-883 METHOD | TEST | | READ AND RECORD | |
|--------------------|--------------------|-----------|------------|-----------------|------------|
| | | PRE-IRRAD | POST-IRRAD | PRE-IRRAD | POST-IRRAD |
| Group E Subgroup 2 | 5005 | 1, 7, 9 | Table 4 | 1, 9 | Table 4 |

TABLE 8. BURN-IN AND IRRADIATION TEST CONNECTIONS

| FUNCTION | OPEN | GROUND | VDD | 9V ± 0.5V | OSCILLATOR | |
|-------------------------|-------|-----------------|-----------------------------|-----------|---------------------------|----------------------------|
| | | | | | 50kHz | 25kHz |
| PART NUMBER CD4067BMS | | | | | | |
| Static Burn-In 1 Note 1 | 1 | 2 - 23 | 24 | | | |
| Static Burn-In 2 Note 1 | 1 | 12 | 2 - 11, 13 - 24 | | | |
| Dynamic Burn-In Note 1 | - | 12, 15 | 24 | 1 | 2 - 9, 16 - 23 | 10, 11, 13, 14 (Note 3) |
| Irradiation Note 2 | 1 | 12 | 2 - 11, 13 - 24 | | | |
| PART NUMBER CD4097BMS | | | | | | |
| Static Burn-In 1 Note 1 | 1, 17 | 2 - 16, 18 - 23 | 24 | | | |
| Static Burn-In 2 Note 1 | 1, 17 | 12 | 2 - 11, 13 - 16, 18 - 24 | | | |
| Dynamic Burn-In Note 1 | - | 12, 13 | 24 | 1, 17 | 2 - 9, 15, 16, 18 - 23 | 10, 11, 14 (Note 4) |
| Irradiation Note 2 | 1, 17 | 12 | 2 - 11, 13 - 16, 18 - 24 | | | |

NOTE:

1. Each pin except VDD and GND will have a series resistor of 10K ± 5%, VDD = 18V ± 0.5V
2. Each pin except VDD and GND will have a series resistor of 47K ± 5%; Group E, Subgroup 2, sample size is 4 dice/wafer, 0 failures, VDD = 10V ± 0.5V
3. Pin 10 is at 14kHz, Pin 11 is at 7kHz, Pin 13 is at 1.7kHz, Pin 14 is at 3.5kHz
4. Pin 10 is at 14kHz, Pin 11 is at 7kHz, Pin 14 is at 3.5kHz

CD4067BMS, CD4097BMS

Functional Diagram

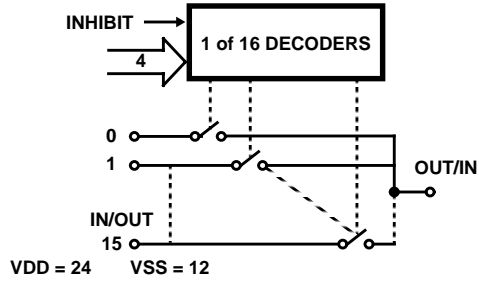

CD4067

CD4067 TRUTH TABLE

| A | B | C | D | Inh | SELECTED CHANNEL |
|---|---|---|---|-----|------------------|
| X | X | X | X | 1 | None |
| 0 | 0 | 0 | 0 | 0 | 0 |
| 1 | 0 | 0 | 0 | 0 | 1 |
| 0 | 1 | 0 | 0 | 0 | 2 |
| 1 | 1 | 0 | 0 | 0 | 3 |
| 0 | 0 | 1 | 0 | 0 | 4 |
| 1 | 0 | 1 | 0 | 0 | 5 |
| 0 | 1 | 1 | 0 | 0 | 6 |
| 1 | 1 | 1 | 0 | 0 | 7 |
| 0 | 0 | 0 | 1 | 0 | 8 |
| 1 | 0 | 0 | 1 | 0 | 9 |
| 0 | 1 | 0 | 1 | 0 | 10 |
| 1 | 1 | 0 | 1 | 0 | 11 |
| 0 | 0 | 1 | 1 | 0 | 12 |
| 1 | 0 | 1 | 1 | 0 | 13 |
| 0 | 1 | 1 | 1 | 0 | 14 |
| 1 | 1 | 1 | 1 | 0 | 15 |

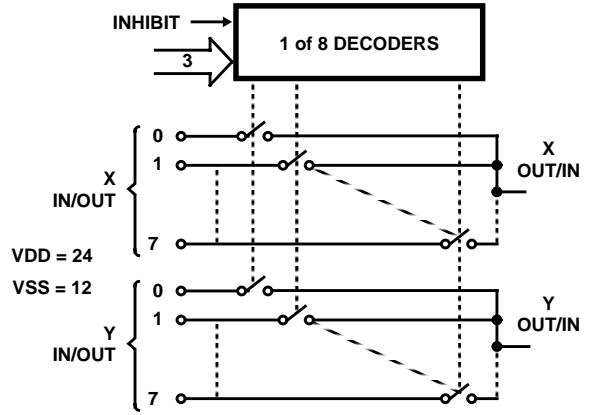

CD4097

CD4097 TRUTH TABLE

| A | B | C | Inh | SELECTED CHANNEL |
|---|---|---|-----|------------------|
| X | X | X | 1 | None |
| 0 | 0 | 0 | 0 | 0X, 0Y |
| 1 | 0 | 0 | 0 | 1X, 1Y |
| 0 | 1 | 0 | 0 | 2X, 2Y |
| 1 | 1 | 0 | 0 | 3X, 3Y |
| 0 | 0 | 1 | 0 | 4X, 4Y |
| 1 | 0 | 1 | 0 | 5X, 5Y |
| 0 | 1 | 1 | 0 | 6X, 6Y |
| 1 | 1 | 1 | 0 | 7X, 7Y |

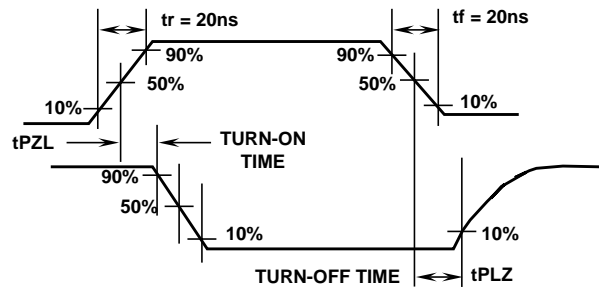

FIGURE 1. WAVEFORM CHANNEL BEING TURNED ON, OFF

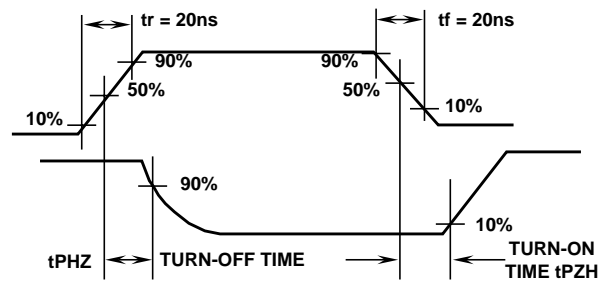

FIGURE 2. PROPAGATION DELAY WAVEFORM, CHANNEL BEING TURNED OFF, ON

CD4067BMS, CD4097BMS

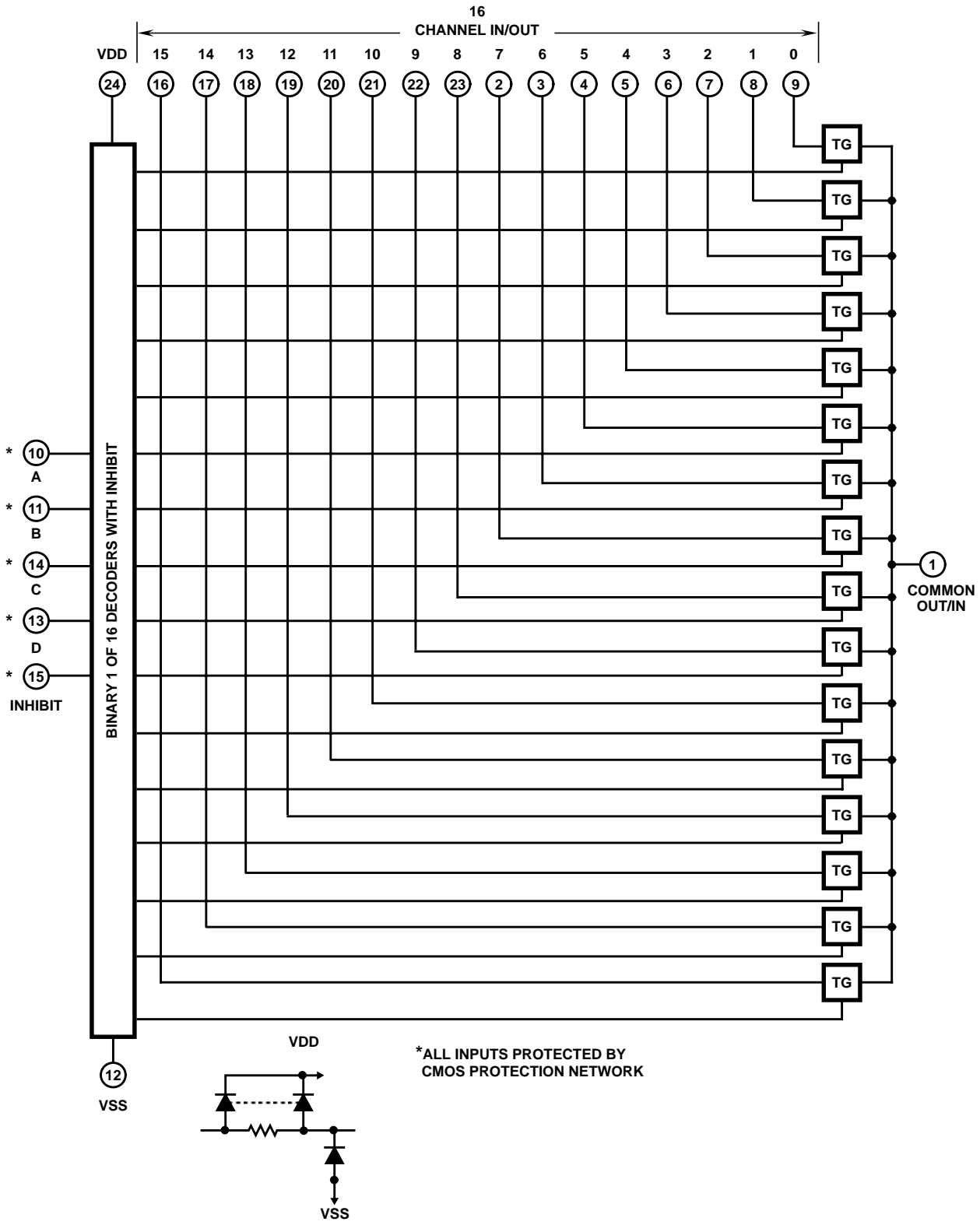

FIGURE 3. CD4067BMS LOGIC DIAGRAM

CD4067BMS, CD4097BMS

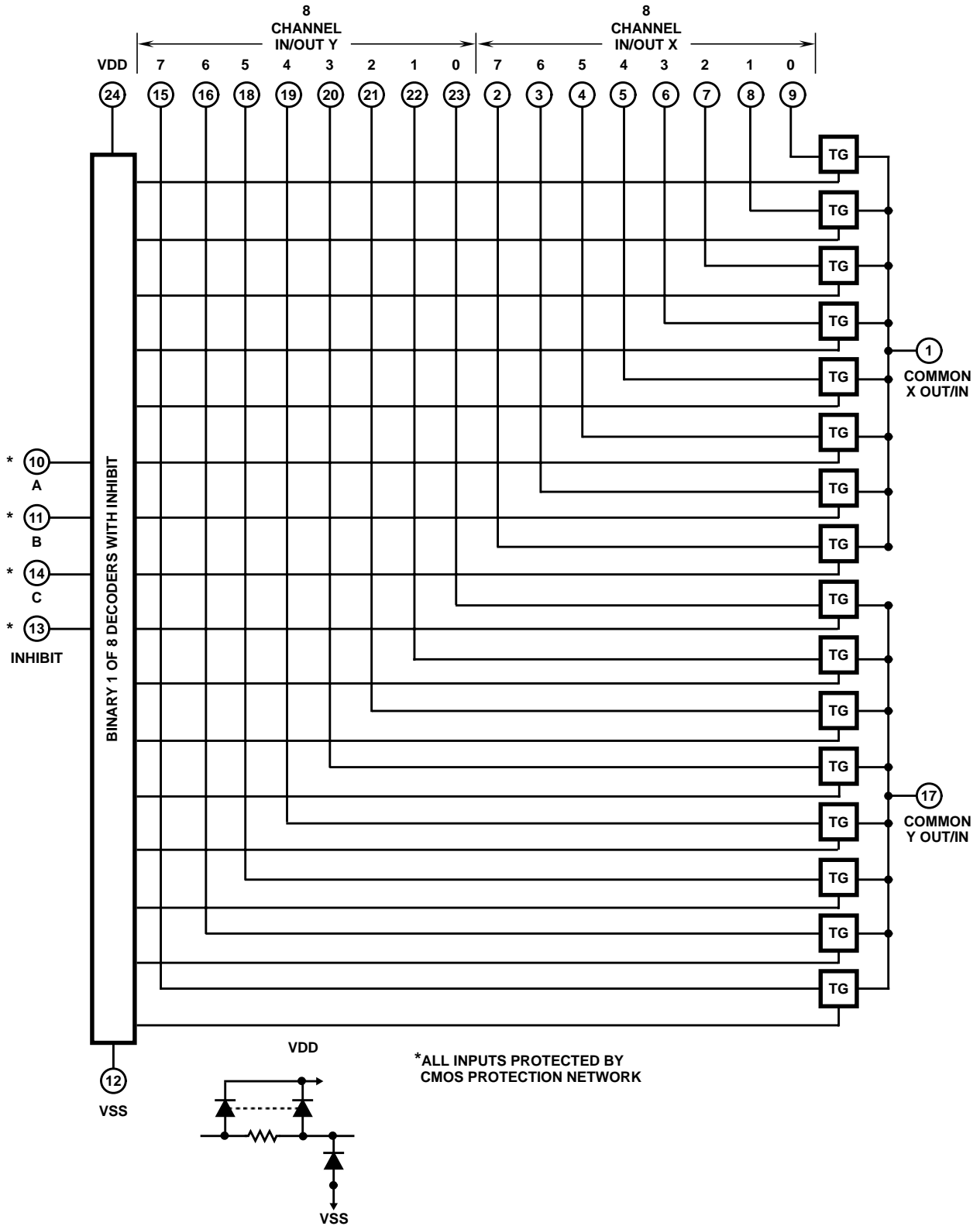

FIGURE 4. CD4097BMS LOGIC DIAGRAM

CD4067BMS, CD4097BMS

Typical Performance Characteristics

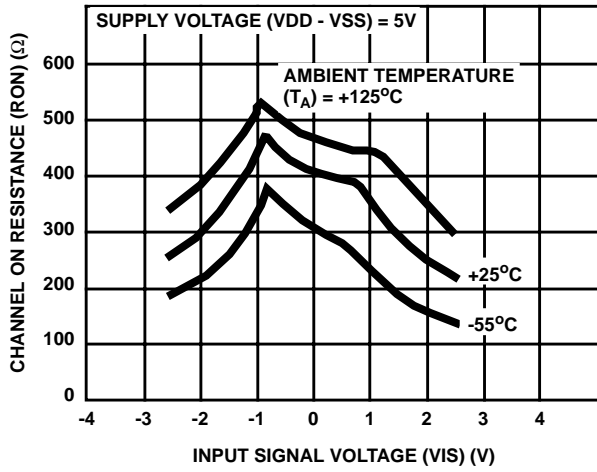

FIGURE 5. TYPICAL ON RESISTANCE vs INPUT SIGNAL VOLTAGE (ALL TYPES)

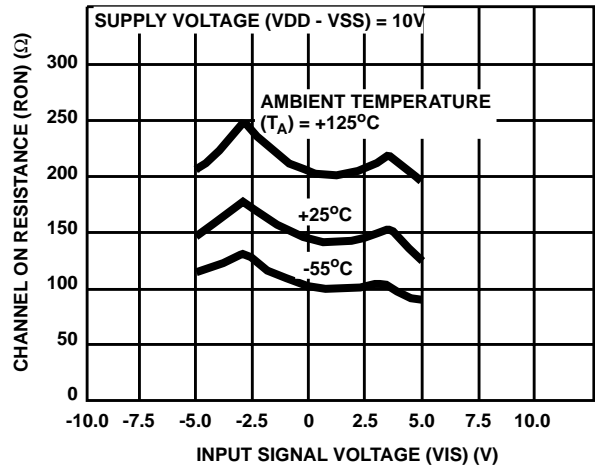

FIGURE 6. TYPICAL ON RESISTANCE vs INPUT SIGNAL VOLTAGE (ALL TYPES)

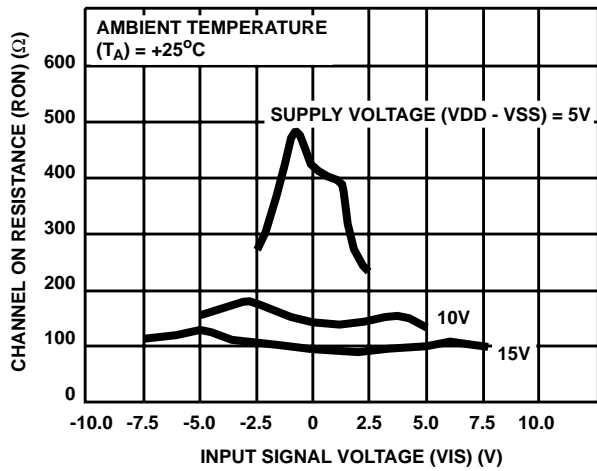

FIGURE 7. TYPICAL ON RESISTANCE vs INPUT SIGNAL VOLTAGE (ALL TYPES)

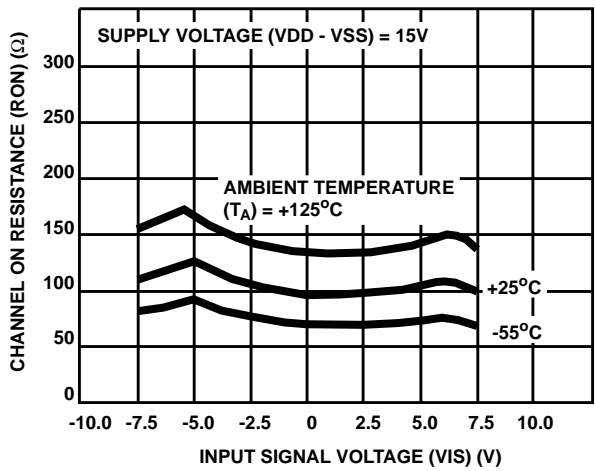
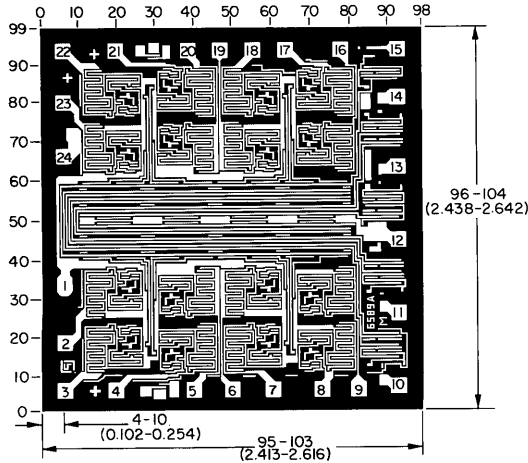

FIGURE 8. TYPICAL ON RESISTANCE vs INPUT SIGNAL VOLTAGE (ALL TYPES)

CD4067BMS, CD4097BMS

Chip Dimensions and Pad Layouts



CD4067BMSH

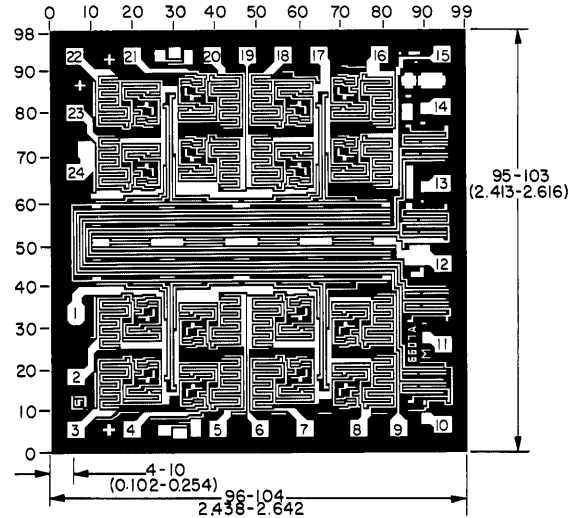

CD4097BMSH

Dimensions in parentheses are in millimeters
and are derived from the basic inch dimensions
as indicated. Grid graduations are in mils (10^{-3} inch)

Special Considerations

In applications where separate power sources are used to drive VDD and the signal inputs, the VDD current capability should exceed VDD/RL (RL = effective external load). This provision avoids permanent current flow or clamp action on the VDD supply when power is applied or removed from the CD4067BMS or CD4097BMS.

When switching from one address to another, some of the ON periods of the channels of the multiplexers will overlap momentarily, which may be objectionable in certain applications. Also when a channel is turned on or off by an address input, there is a momentary conductive path from the channel to VSS, which will dump some charge from any capacitor connected to the input or output of the channel. The inhibit input turning on a channel will similarly dump some charge to VSS.

The amount of charge dumped is mostly a function of the signal level above VSS. Typically, at $VDD - VSS = 10V$, a 100pF capacitor connected to the input or output of the

channel will lose 3 to 4% of its voltage at the moment the channel turns on or off. This loss of voltage is essentially independent of the address or inhibit signal transition time, if the transition time is less than 1 - 2 μ s. When the inhibit signal turns a channel off, there is no charge dumping to VSS. Rather, there is a slight rise in the channel voltage level (65mV typ.) due to capacitive coupling from inhibit input to channel input or output. Address inputs also couple some voltage steps onto the channel signal levels.

In certain applications, the external load resistor current may include both VDD and signal-line components. To avoid drawing VDD current when switch current flows into the transmission gate inputs, the voltage drop across the bidirectional switch must not exceed 0.8 volt (calculated from R_{ON} values shown in ELECTRICAL CHARACTERISTICS CHART - Table 1). no VDD current will flow through RL if the switch current flows into terminal 1 on the CD4067BMS, terminals 1 and 17 on the CD4097BMS.

METALLIZATION: Thickness: 11kÅ - 14kÅ, AL.

PASSIVATION: 10.4kÅ - 15.6kÅ, Silane

BOND PADS: 0.004 inches X 0.004 inches MIN

DIE THICKNESS: 0.0198 inches - 0.0218 inches

All Intersil semiconductor products are manufactured, assembled and tested under **ISO9000** quality systems certification.

Intersil products are sold by description only. Intersil Corporation reserves the right to make changes in circuit design and/or specifications at any time without notice. Accordingly, the reader is cautioned to verify that data sheets are current before placing orders. Information furnished by Intersil is believed to be accurate and reliable. However, no responsibility is assumed by Intersil or its subsidiaries for its use; nor for any infringements of patents or other rights of third parties which may result from its use. No license is granted by implication or otherwise under any patent or patent rights of Intersil or its subsidiaries.

For information regarding Intersil Corporation and its products, see web site <http://www.intersil.com>