

## Intelligent Power Module ( R-Series )

### Maximum Ratings and Characteristics

#### Absolute Maximum Ratings ( T<sub>c</sub>=25°C )

Items	Symbols	Ratings		Units
		Min.	Max.	
DC Bus Voltage	V <sub>DC</sub>	0	450	V
DC Bus Voltage (surge)	V <sub>DC(Surge)</sub>	0	500	
DC Bus Voltage (short operating)	V <sub>SC</sub>	200	400	
Collector-Emitter Voltage	V <sub>CES</sub>	0	600	
Inverter Collector Current	Continuous	I <sub>C</sub>	75	A
	1ms	I <sub>CP</sub>	150	
Current	Duty=61.7%	-I <sub>C</sub>	75	
Collector Power Dissipation	One Transistor	P <sub>C</sub>	320	W
Dynamic Brake Collector Current	Continuous	I <sub>C</sub>	50	A
	1ms	I <sub>CP</sub>	100	
Forward Current of Diode	I <sub>F</sub>		50	
Collector Power Dissi. DB	One Transistor	P <sub>C</sub>	198	W
Voltage of Power Supply for Driver	V <sub>CC</sub> *1	0	20	V
Input Signal Voltage	V <sub>IN</sub> *2	0	V <sub>Z</sub>	
Input Signal Current	I <sub>IN</sub>		1	mA
Alarm Signal Voltage	V <sub>ALM</sub> *3	0	V <sub>CC</sub>	V
Alarm Signal Current	I <sub>ALM</sub> *4		15	mA
Junction Temperature	T <sub>J</sub>		150	°C
Operating Temperature	T <sub>OP</sub>	-20	100	
Storage Temperature	T <sub>stg</sub>	-40	125	
Isolation Voltage	A.C. 1min.	V <sub>ISO</sub>	2500	V
Screw Torque	Mounting *1		3.5	Nm
	Terminals *1		3.5	

Note: \*1: Recommendable Value; 2.5 - 3.0 Nm (M5)

### Outline Drawing

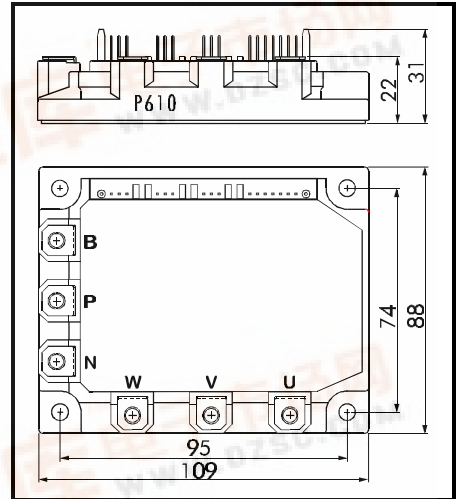

Fig. 1

#### Electrical Characteristics of Power Circuit ( at T<sub>J</sub>=25°C, V<sub>CC</sub>=15V )

Items	Symbols	Conditions	Min.	Typ.	Max.	Units	
INV	Collector Current At Off Signal Input	I <sub>CES</sub>	V <sub>CE</sub> =600V, Input Terminal Open			1.0	mA
	Collector-Emitter Saturation Voltage	V <sub>CE(Sat)</sub>	I <sub>C</sub> =75A			2.8	V
	Forward Voltage of FWD	V <sub>F</sub>	-I <sub>C</sub> =75A			3.0	V
DB	Collector Current At Off Signal Input	I <sub>CES</sub>	V <sub>CE</sub> =600V, Input Terminal Open			1.0	mA
	Collector-Emitter Saturation Voltage	V <sub>CE(Sat)</sub>	I <sub>C</sub> =50A			2.8	V
	Forward Voltage of FWD	V <sub>F</sub>	-I <sub>C</sub> =50A			3.3	V

#### Electrical Characteristics of Control Circuit ( at T<sub>J</sub>=25°C, V<sub>CC</sub>=15V )

Items	Symbols	Conditions	Min.	Typ.	Max.	Units
Current of P-Line Side Driver (One Unit)	I <sub>CCP</sub>	f <sub>SW</sub> =0~15kHz, T <sub>C</sub> =-20~100°C	3		18	mA
Current of N-Line Side Driver (Three Units)	I <sub>CCN</sub>	f <sub>SW</sub> =0~15kHz, T <sub>C</sub> =-20~100°C	10		65	
Input Signal Threshold Voltage	V <sub>IN(th)</sub>	On	1.00	1.35	1.70	V
		Off	1.25	1.60	1.95	
Input Zener Voltage	V <sub>Z</sub>	R <sub>IN</sub> =20kΩ		8.0		
Over Heating Protection Temperature Level	T <sub>COH</sub>	V <sub>DC</sub> =0V, I <sub>C</sub> =0A, Case Temp.	110		125	°C
Hysteresis	T <sub>CH</sub>			20		
IGBT Chips Over Heating Protec. Temp. Level	T <sub>JOH</sub>	Surface of IGBT Chip	150			
Hysteresis	T <sub>JH</sub>			20		
Inverter Collector Current Protection Level	I <sub>OC</sub>	T <sub>J</sub> =125°C	113			A
DB Collector Current Protection Level	I <sub>OC</sub>	T <sub>J</sub> =125°C	75			
Over Current Detecting Time	t <sub>DOC</sub>	T <sub>J</sub> =25°C		10		μs
Alarm Signal Hold Time	t <sub>ALM</sub>		1.5	2		ms
Limiting Resistor for Alarm	R <sub>ALM</sub>		1425	1500	1575	Ω
Under Voltage Protection Level	V <sub>UV</sub>		11.0		12.5	V
Hysteresis	V <sub>H</sub>		0.2			

#### Dynamic Characteristics ( at T<sub>C</sub>=T<sub>J</sub>=125°C, V<sub>CC</sub>=15V )

Items	Symbols	Conditions	Min.	Typ.	Max.	Units
Switching Time	t <sub>ON</sub>	I <sub>C</sub> =75A, V <sub>DC</sub> =300V	0.3			μs
	t <sub>OFF</sub>				3.6	
	t <sub>RR</sub>	I <sub>F</sub> =75A, V <sub>DC</sub> =300V			0.4	



• Thermal Characteristics

Items	Symbols	Conditions	Min.	Typ.	Max.	Units
Thermal Resistance	$R_{th(i-c)}$	Inverter IGBT			0.39	°C/W
	$R_{th(i-c)}$	Diode			0.90	
	$R_{th(i-c)}$	DB IGBT			0.63	
	$R_{th(c-f)}$	With Thermal Compound		0.05		

■ Equivalent Circuit

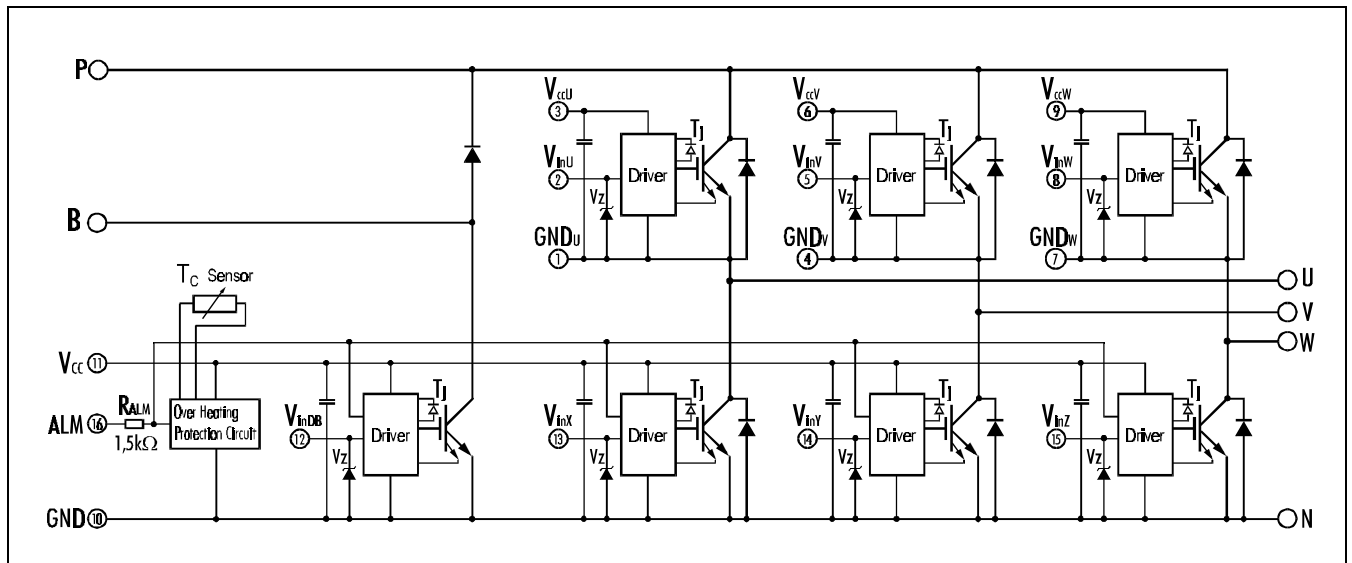

Drivers include following functions

- Short circuit protection circuit
- Amplifier for driver
- Undervoltage protection circuit
- Overcurrent protection circuit
- IGBT Chip overheating protection

## Dynamic Brake

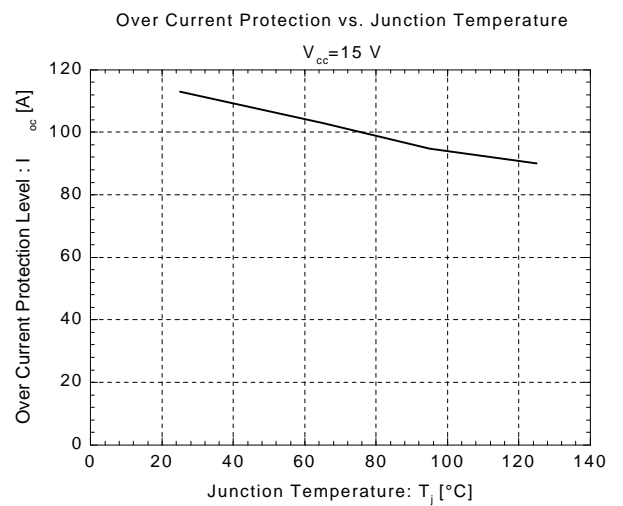
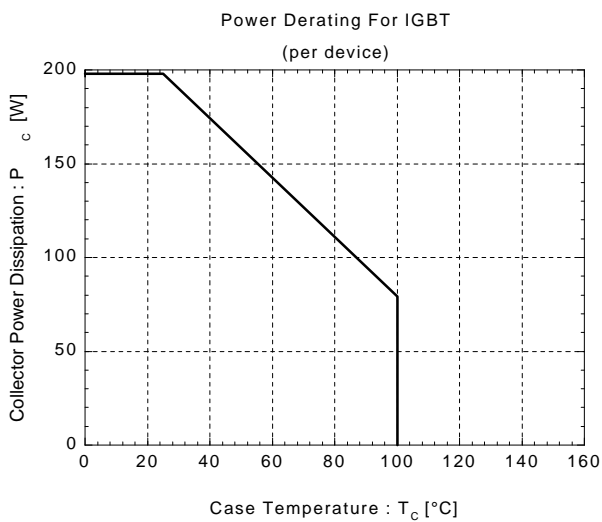
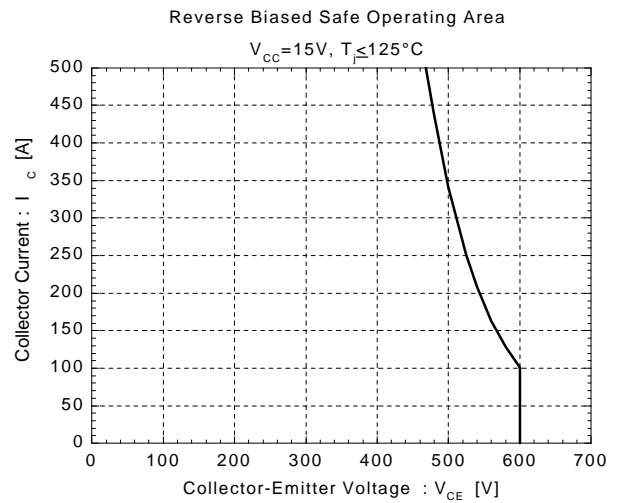
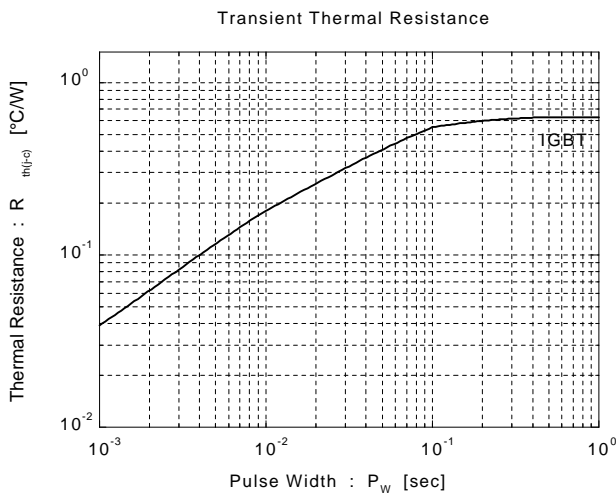
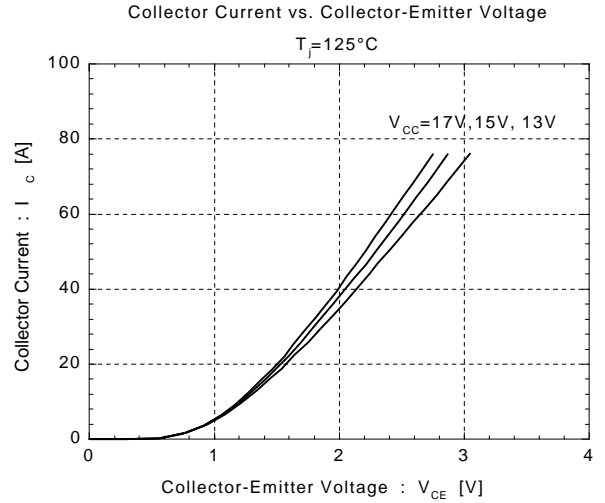
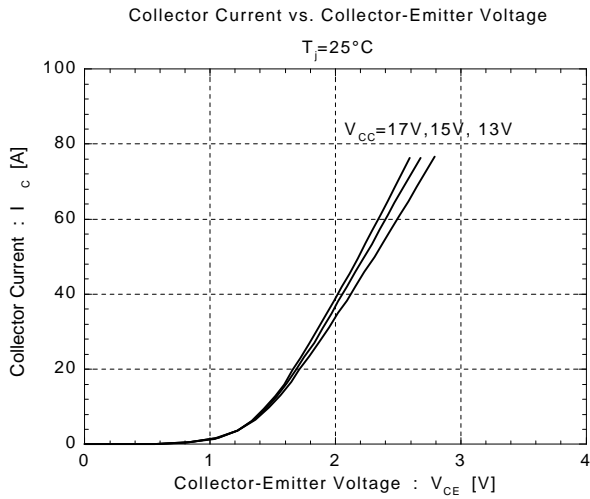

## Control Circuit

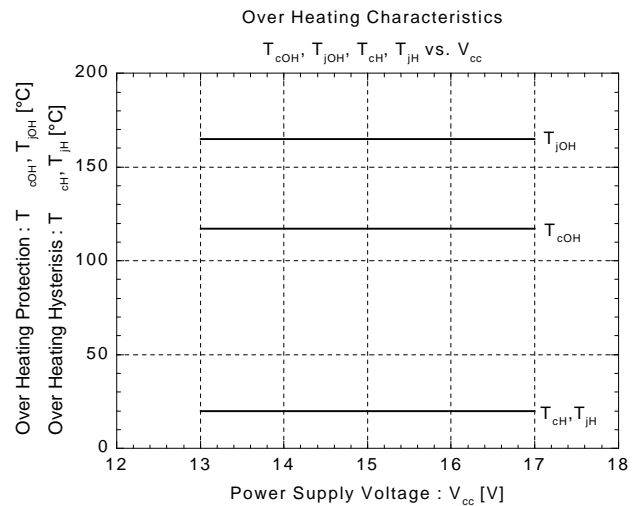
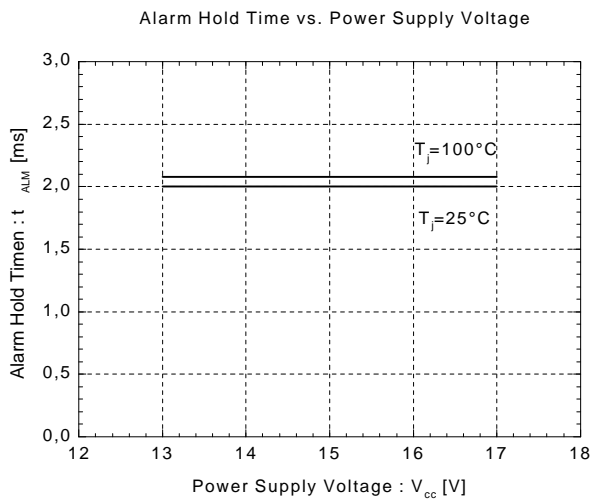
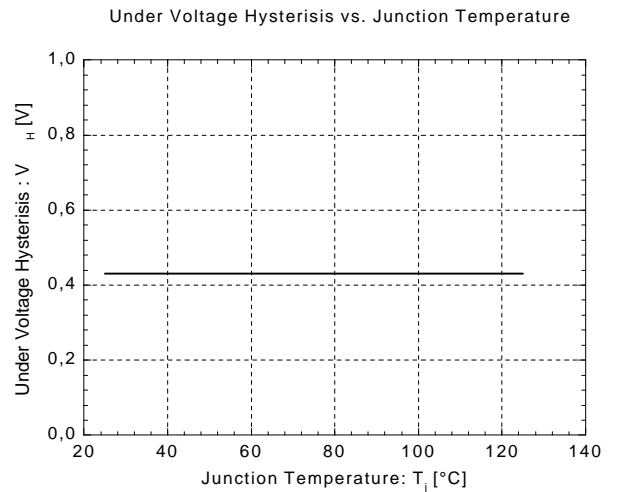
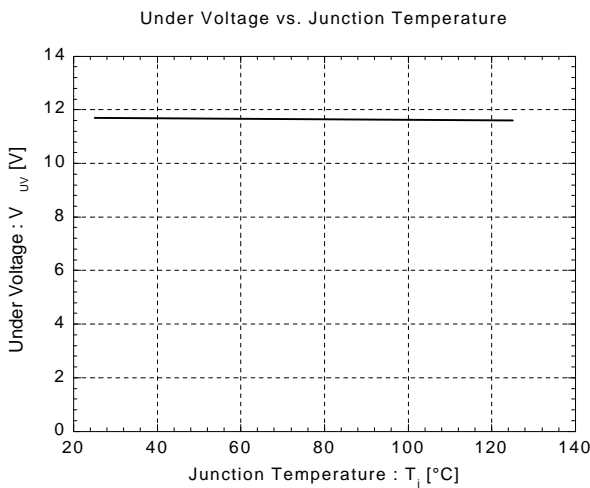
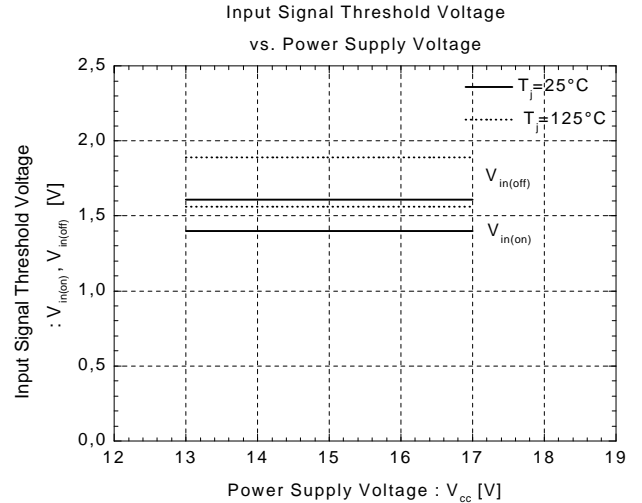
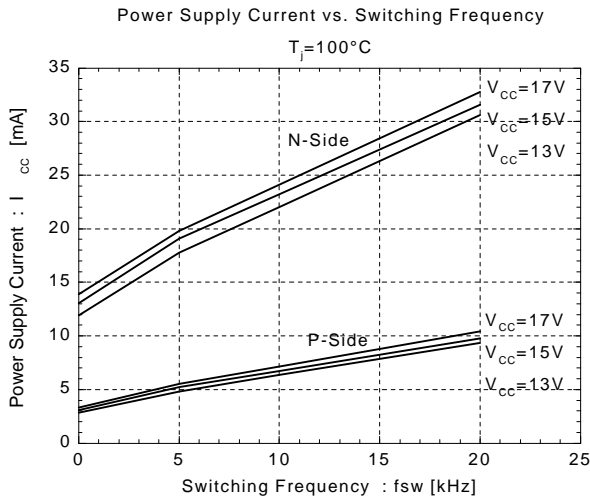

## ■ Inverter

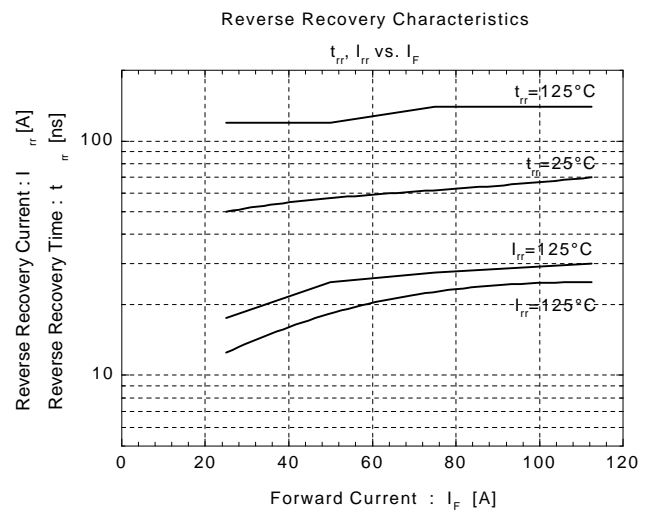
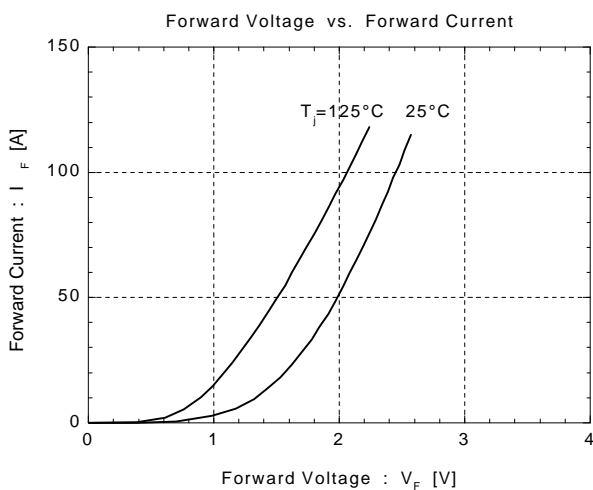
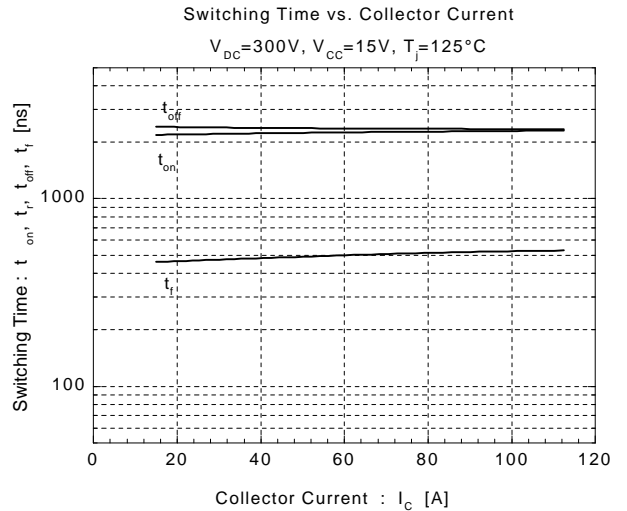
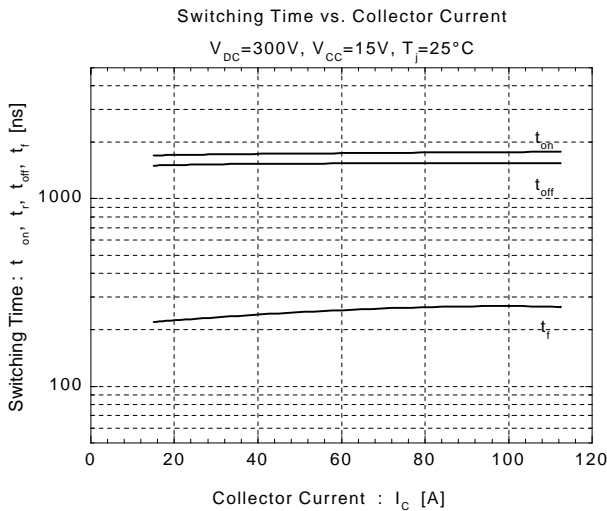
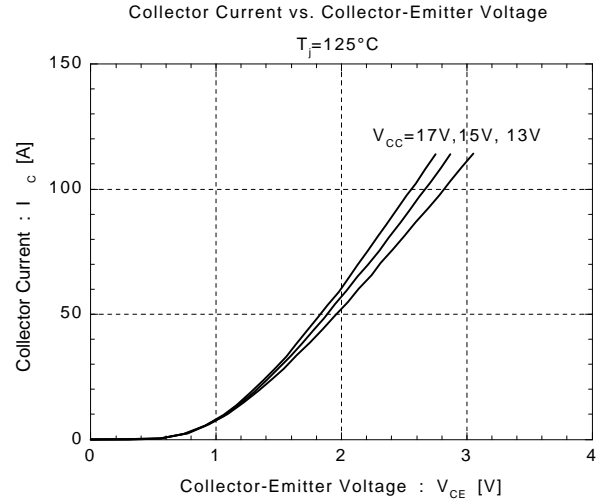
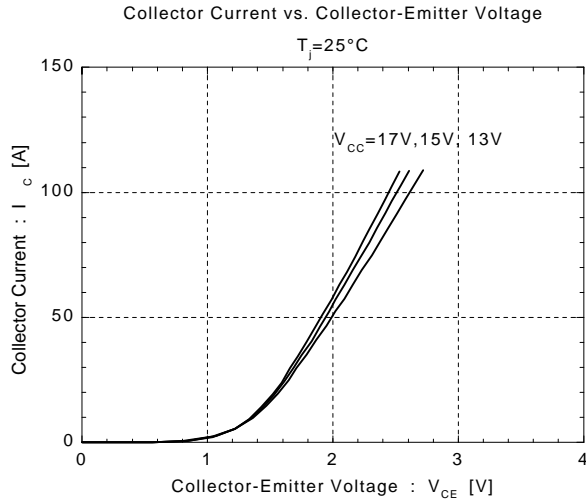

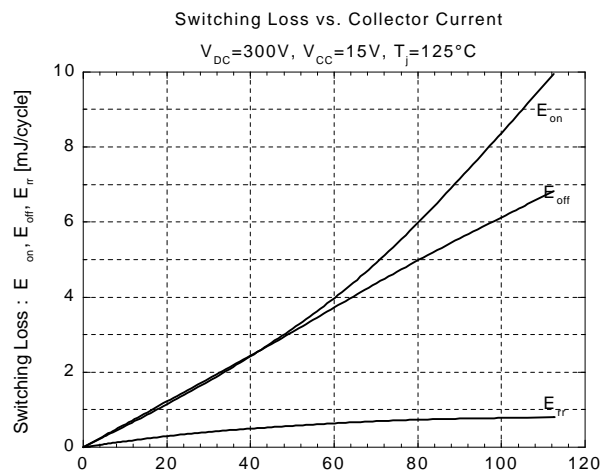
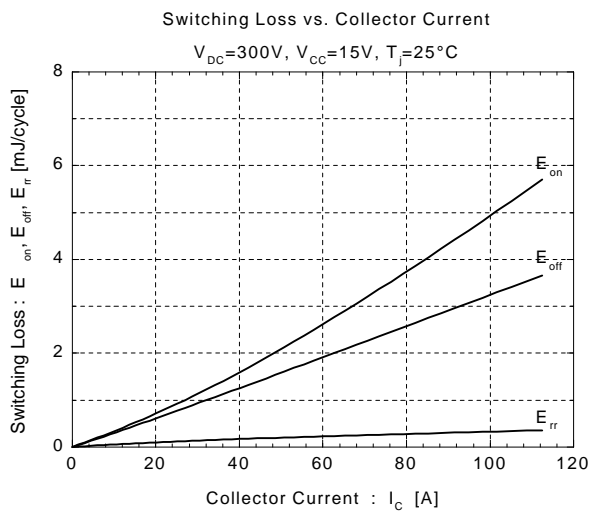
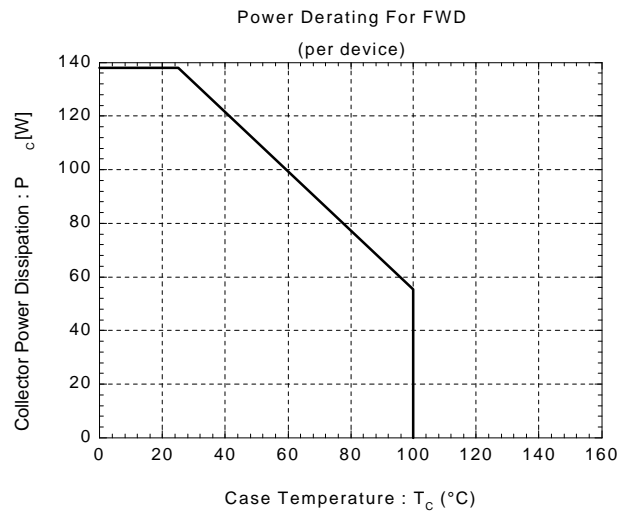
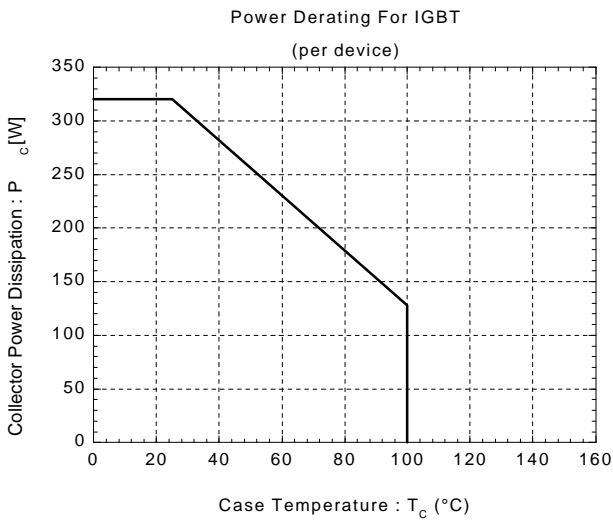
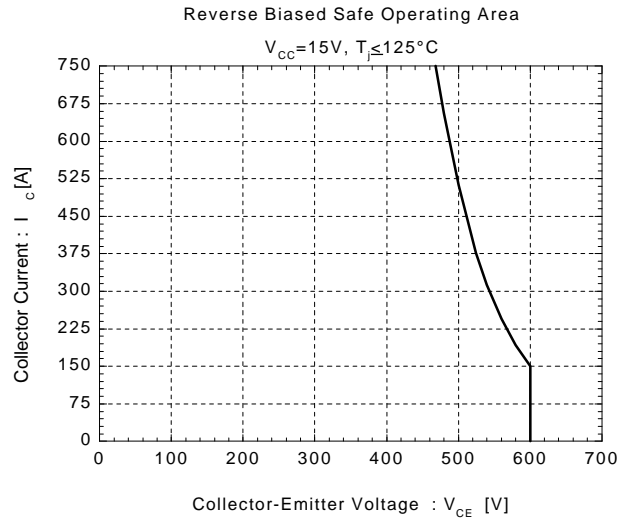
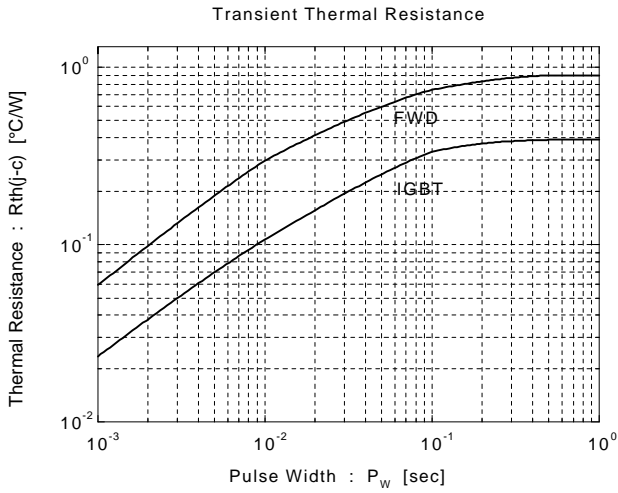

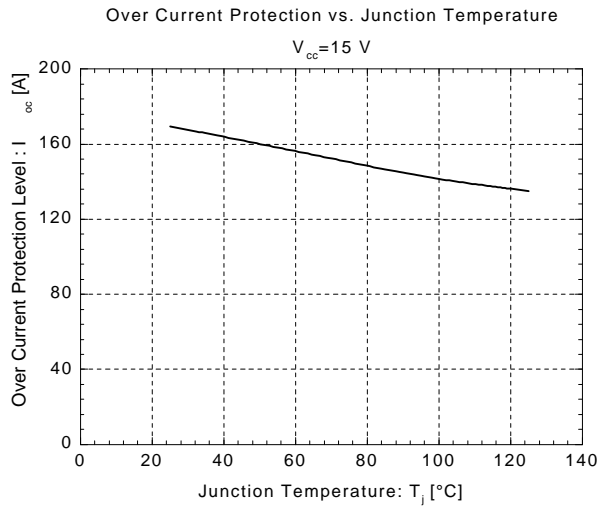

■ Outline Drawing

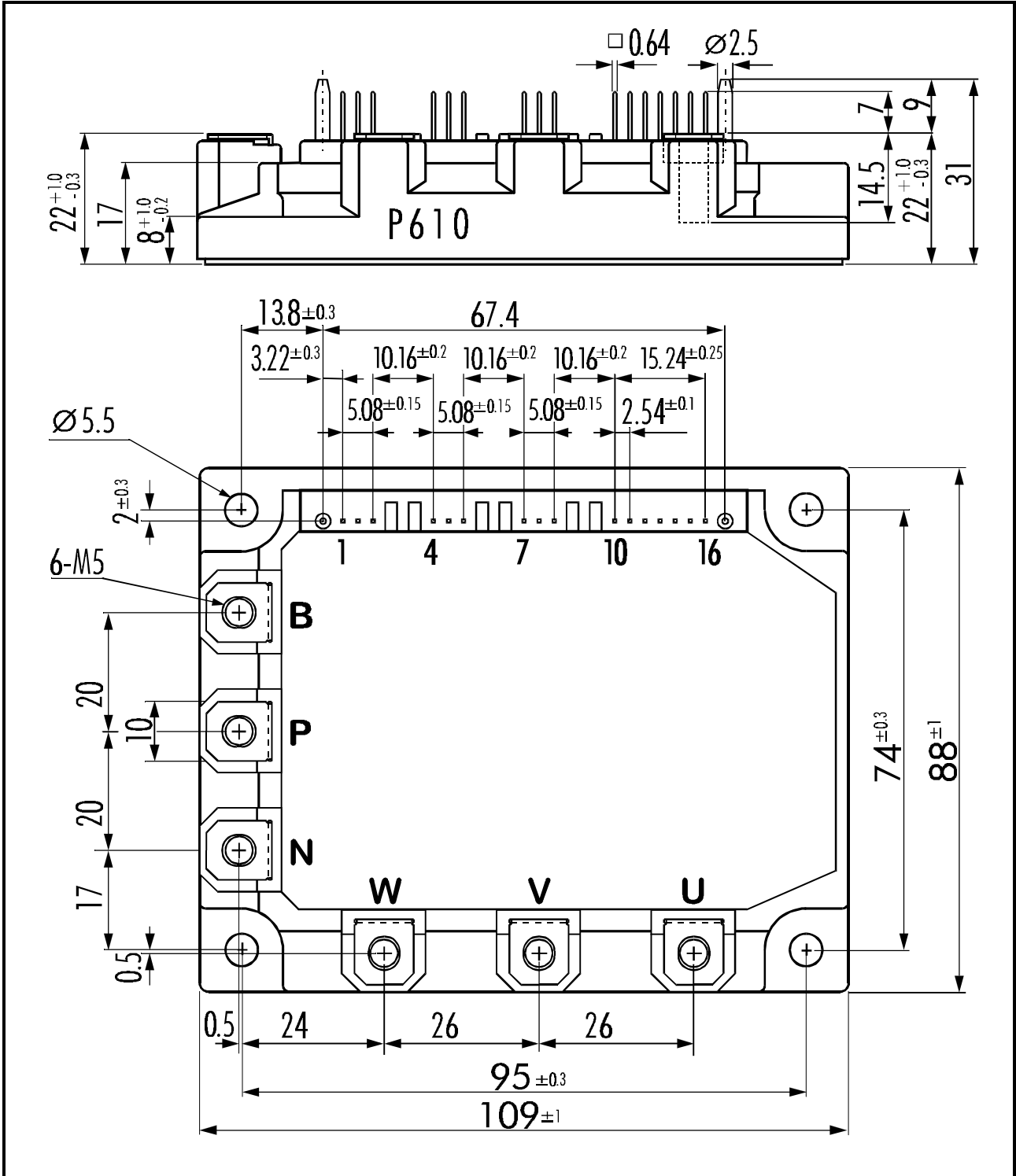

**Weight: 440g**



For more information, contact:

**Collmer Semiconductor, Inc.**

P.O. Box 702708

Dallas, TX 75370

972-233-1589

972-233-0481 Fax

<http://www.collmer.com>