

LM2681 Switched Capacitor Voltage Converter

General Description

The LM2681 CMOS charge-pump voltage converter operates as a voltage doubler for an input voltage in the range of +2.5V to +5.5V. Two low cost capacitors and a diode (needed during start-up) is used in this circuit to provide up to 20 mA of output current. The LM2681 can also work as a voltage divider to split a voltage in the range of +1.8V to +11V in half.

The LM2681 operates at 160 kHz oscillator frequency to reduce output resistance and voltage ripple. With an operating current of only 550 μ A (operating efficiency greater than 90% with most loads) the LM2681 provides ideal performance for battery powered systems. The device is in SOT-23-6 package.

Features

- Doubles or Splits Input Supply Voltage
- SOT23-6 Package
- 15 Ω Typical Output Impedance
- 90% Typical Conversion Efficiency at 20 mA

Applications

- Cellular Phones
- Pagers
- PDAs
- Operational Amplifier Power Suppliers
- Interface Power Suppliers
- Handheld Instruments

Basic Application Circuits

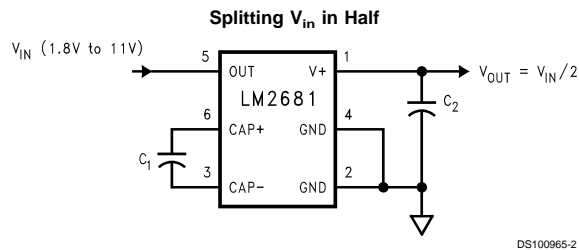
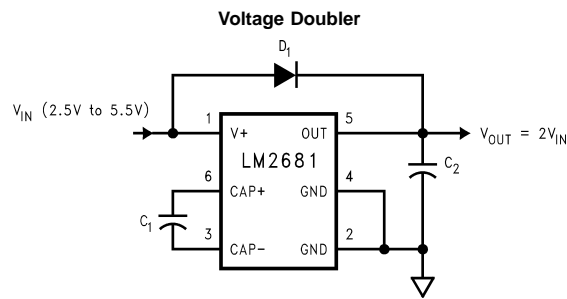

Absolute Maximum Ratings (Note 1)

If Military/Aerospace specified devices are required, please contact the National Semiconductor Sales Office/Distributors for availability and specifications.

Supply Voltage (V+ to GND, or GND to OUT)	5.8V
V+ and OUT Continuous Output Current	30 mA
Output Short-Circuit Duration to GND (Note 2)	1 sec.
Continuous Power Dissipation (T _A = 25°C)(Note 3)	600 mW

T _{JMax} (Note 3)	150°C
θ _{JA} (Note 3)	210°C/W
Operating Junction Temperature Range	-40° to 85°C
Storage Temperature Range	-65°C to +150°C
Lead Temp. (Soldering, 10 seconds)	300°C
ESD Rating	2kV

Electrical Characteristics

Limits in standard typeface are for T_J = 25°C, and limits in **boldface** type apply over the full operating temperature range. Unless otherwise specified: V+ = 5V, C₁ = C₂ = 3.3 μF. (Note 4)

Symbol	Parameter	Condition	Min	Typ	Max	Units
V+	Supply Voltage		2.5		5.5	V
I _Q	Supply Current	No Load		550	1000	μA
I _L	Output Current		20			mA
R _{SW}	Sum of the R _{ds(on)} of the four internal MOSFET switches	I _L = 20 mA		8	16	Ω
R _{OUT}	Output Resistance (Note 5)	I _L = 20 mA		15	40	Ω
f _{OSC}	Oscillator Frequency	(Note 6)	80	160		kHz
f _{SW}	Switching Frequency	(Note 6)	40	80		kHz
P _{EFF}	Power Efficiency	R _L (1.0k) between GND and OUT I _L = 20 mA to GND	86	93		%
V _{OEFF}	Voltage Conversion Efficiency	No Load	99	99.96		%

Note 1: Absolute maximum ratings indicate limits beyond which damage to the device may occur. Electrical specifications do not apply when operating the device beyond its rated operating conditions.

Note 2: OUT may be shorted to GND for one second without damage. However, shorting OUT to V+ may damage the device and should be avoided. Also, for temperatures above 85°C, OUT must not be shorted to GND or V+, or device may be damaged.

Note 3: The maximum allowable power dissipation is calculated by using $P_{DMax} = (T_{JMax} - T_A)/\theta_{JA}$, where T_{JMax} is the maximum junction temperature, T_A is the ambient temperature, and θ_{JA} is the junction-to-ambient thermal resistance of the specified package.

Note 4: In the test circuit, capacitors C₁ and C₂ are 3.3 μF, 0.3Ω maximum ESR capacitors. Capacitors with higher ESR will increase output resistance, reduce output voltage and efficiency.

Note 5: Specified output resistance includes internal switch resistance and capacitor ESR. See the details in the application information for positive voltage doubler.

Note 6: The output switches operate at one half of the oscillator frequency, f_{OSC} = 2f_{SW}.

Test Circuit

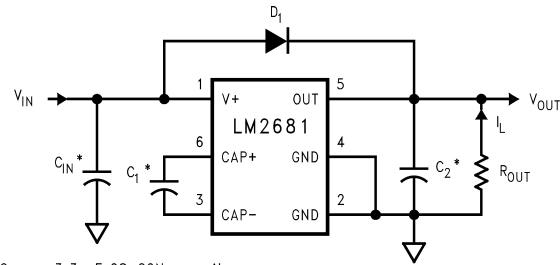

* C_{IN} , C_1 , and C_2 are $3.3 \mu\text{F}$ OS-CON capacitors.

DS100965-3

FIGURE 1. LM2681 Test Circuit

Typical Performance Characteristics (Circuit of Figure 1, $V_+ = 5\text{V}$ unless otherwise specified)

Supply Current vs Supply Voltage

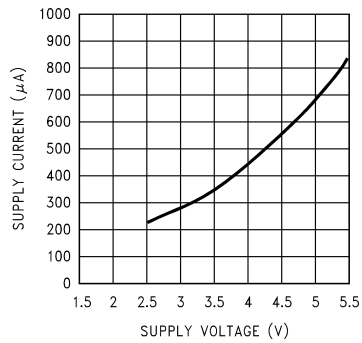

DS100965-4

Supply Current vs Temperature

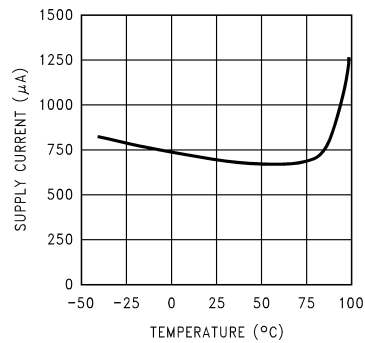

DS100965-5

Output Source Resistance vs Supply Voltage

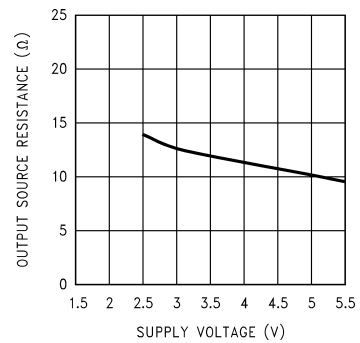

DS100965-6

Output Source Resistance vs Temperature

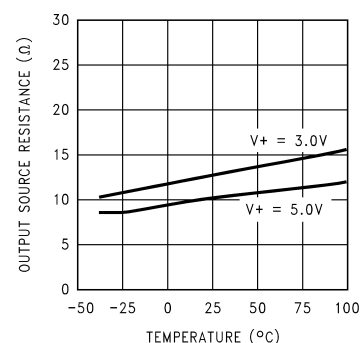

DS100965-7

Typical Performance Characteristics (Circuit of Figure 1, $V_+ = 5V$ unless otherwise specified) (Continued)

Output Voltage Drop vs Load Current

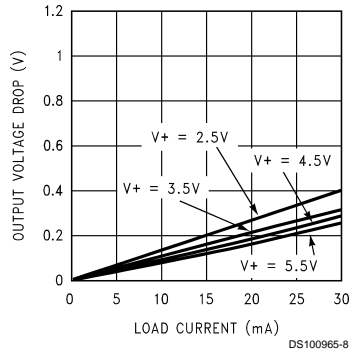

Efficiency vs Load Current

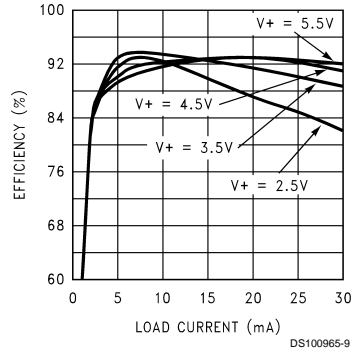

Oscillator Frequency vs Supply Voltage

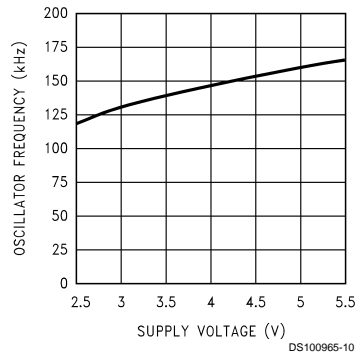

Oscillator Frequency vs Temperature

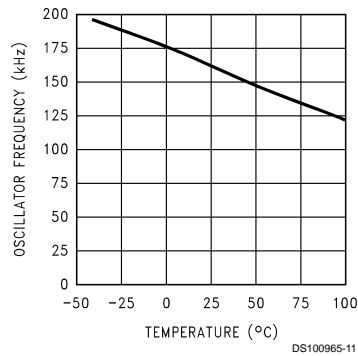

Connection Diagram

6-Lead SOT (M6)

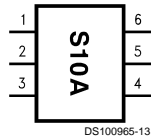

Top View With Package Marking



Actual Size

Ordering Information

Order Number	Package Number	Package Marking	Supplied as
LM2681M6	MA06A	S10A (Note 7)	Tape and Reel (250 units/rail)
LM2681M6X	MA06A	S10A (Note 7)	Tape and Reel (3000 units/rail)

Note 7: The first letter "S" identifies the part as a switched capacitor converter. The next two numbers are the device number. The fourth letter "A" indicates the grade. Only one grade is available. Larger quantity reels are available upon request.

Pin Description

Pin	Name	Function	
		Voltage Doubler	Voltage Split
1	V+	Power supply positive voltage input	Positive voltage output
2	GND	Power supply ground input	Same as doubler
3	CAP-	Connect this pin to the negative terminal of the charge-pump capacitor	Same as doubler
4	GND	Power supply ground input	Same as doubler
5	OUT	Positive voltage output	Power supply positive voltage input
6	CAP+	Connect this pin to the positive terminal of the charge-pump capacitor	Same as doubler

Circuit Description

The LM2681 contains four large CMOS switches which are switched in a sequence to double the input supply voltage. Energy transfer and storage are provided by external capacitors. Figure 2 illustrates the voltage conversion scheme. When S_2 and S_4 are closed, C_1 charges to the supply voltage $V+$. During this time interval, switches S_1 and S_3 are open. In the next time interval, S_2 and S_4 are open; at the same time, S_1 and S_3 are closed, the sum of the input voltage $V+$ and the voltage across C_1 gives the $2V+$ output voltage when there is no load. The output voltage drop when a load is added is determined by the parasitic resistance ($R_{d-s(on)}$) of the MOSFET switches and the ESR of the capacitors) and the charge transfer loss between capacitors. Details will be discussed in the following application information section.

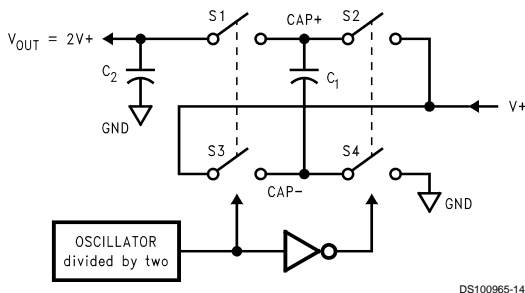

FIGURE 2. Voltage Doubling Principle

Application Information

Positive Voltage Doubler

The main application of the LM2681 is to double the input voltage. The range of the input supply voltage is 2.5V to 5.5V.

The output characteristics of this circuit can be approximated by an ideal voltage source in series with a resistance. The voltage source equals $2V+$. The output resistance R_{out} is a function of the ON resistance of the internal MOSFET switches, the oscillator frequency, the capacitance and ESR of C_1 and C_2 . Since the switching current charging and discharging C_1 is approximately twice as the output current, the effect of the ESR of the pumping capacitor C_1 will be multiplied by four in the output resistance. The output capacitor C_2 is charging and discharging at a current approximately

equal to the output current, therefore, its ESR only counts once in the output resistance. A good approximation of R_{out} is:

$$R_{OUT} \cong 2R_{SW} + \frac{2}{f_{OSC} \times C_1} + 4ESR_{C1} + ESR_{C2}$$

where R_{SW} is the sum of the ON resistance of the internal MOSFET switches shown in Figure 2.

The peak-to-peak output voltage ripple is determined by the oscillator frequency, the capacitance and ESR of the output capacitor C_2 :

$$V_{RIPPLE} = \frac{I_L}{f_{OSC} \times C_2} + 2 \times I_L \times ESR_{C2}$$

High capacitance, low ESR capacitors can reduce both the output resistance and the voltage ripple.

The Schottky diode D_1 is only needed for start-up. The internal oscillator circuit uses the OUT pin and the GND pin. Voltage across OUT and GND must be larger than 1.8V to insure the operation of the oscillator. During start-up, D_1 is used to charge up the voltage at the OUT pin to start the oscillator; also, it protects the device from turning-on its own parasitic diode and potentially latching-up. Therefore, the Schottky diode D_1 should have enough current carrying capability to charge the output capacitor at start-up, as well as a low forward voltage to prevent the internal parasitic diode from turning-on. A Schottky diode like 1N5817 can be used for most applications. If the input voltage ramp is less than 10V/ms, a smaller Schottky diode like MBR0520LT1 can be used to reduce the circuit size.

Split V+ in Half

Another interesting application shown in the Basic Application Circuits is using the LM2681 as a precision voltage divider. This circuit can be derived from the voltage doubler by switching the input and output connections. In the voltage divider, the input voltage applies across the OUT pin and the GND pin (which are the power rails for the internal oscillator), therefore no start-up diode is needed. Also, since the off-voltage across each switch equals $V_{in}/2$, the input voltage can be raised to +11V.

Application Information (Continued)

Capacitor Selection

As discussed in the *Positive Voltage Doubler* section, the output resistance and ripple voltage are dependent on the capacitance and ESR values of the external capacitors. The output voltage drop is the load current times the output resistance, and the power efficiency is

$$\eta = \frac{P_{OUT}}{P_{IN}} = \frac{I_L^2 R_L}{I_L^2 R_L + I_L^2 R_{OUT} + I_Q(V+)}$$

Where $I_Q(V+)$ is the quiescent power loss of the IC device, and $I_L^2 R_{out}$ is the conversion loss associated with the switch on-resistance, the two external capacitors and their ESRs.

The selection of capacitors is based on the specifications of the dropout voltage (which equals $I_{out} R_{out}$), the output voltage ripple, and the converter efficiency. Low ESR capacitors (Table 1) are recommended to maximize efficiency, reduce the output voltage drop and voltage ripple.

Low ESR Capacitor Manufacturers

Manufacturer	Phone	Capacitor Type
Nichicon Corp.	(708)-843-7500	PL & PF series, through-hole aluminum electrolytic
AVX Corp.	(803)-448-9411	TPS series, surface-mount tantalum
Sprague	(207)-324-4140	593D, 594D, 595D series, surface-mount tantalum
Sanyo	(619)-661-6835	OS-CON series, through-hole aluminum electrolytic
Murata	(800)-831-9172	Ceramic chip capacitors
Taiyo Yuden	(800)-348-2496	Ceramic chip capacitors
Tokin	(408)-432-8020	Ceramic chip capacitors

Other Applications

Paralleling Devices

Any number of LM2681s can be paralleled to reduce the output resistance. Each device must have its own pumping capacitor C_1 , while only one output capacitor C_{out} is needed as shown in Figure 3. The composite output resistance is:

$$R_{OUT} = \frac{R_{OUT} \text{ of each LM2681}}{\text{Number of Devices}}$$

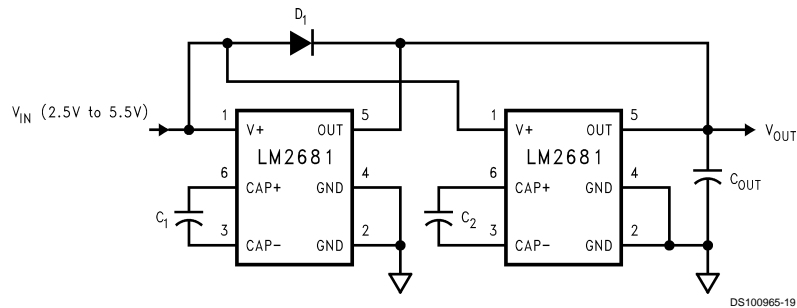

FIGURE 3. Lowering Output Resistance by Paralleling Devices

Cascading Devices

Cascading the LM2681s is an easy way to produce a greater voltage (A two-stage cascade circuit is shown in Figure 4).

The effective output resistance is equal to the weighted sum of each individual device:

$$R_{out} = 1.5R_{out,1} + R_{out,2}$$

Note that, the increasing of the number of cascading stages is practically limited since it significantly reduces the efficiency, increases the output resistance and output voltage ripple.

Other Applications (Continued)

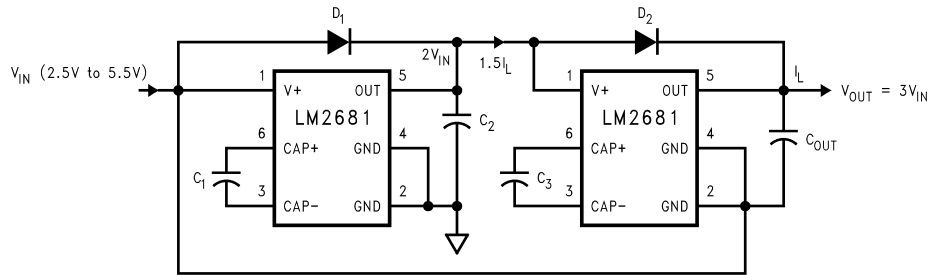

DS100965-20

FIGURE 4. Increasing Output Voltage by Cascading Devices

Regulating V_{OUT}

It is possible to regulate the output of the LM2681 by use of a low dropout regulator (such as LP2980-5.0). The whole converter is depicted in Figure 5.

A different output voltage is possible by use of LP2980-3.3, LP2980-3.0, or LP2980-adj.

Note that, the following conditions must be satisfied simultaneously for worst case design:

$$2V_{in_min} > V_{out_min} + V_{drop_max} (LP2980) + I_{out_max} \times R_{out_max} (LM2681)$$

$$2V_{in_max} < V_{out_max} + V_{drop_min} (LP2980) + I_{out_min} \times R_{out_min} (LM2681)$$

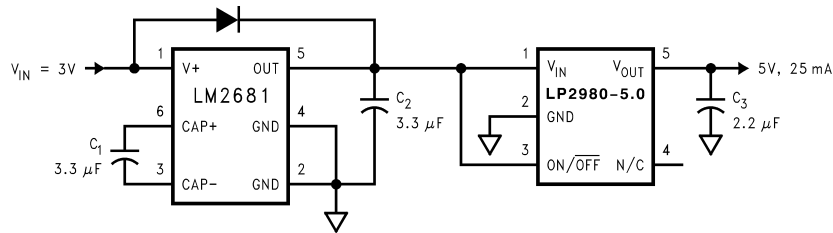

DS100965-21

FIGURE 5. Generate a Regulated +5V from +3V Input Voltage

Physical Dimensions inches (millimeters) unless otherwise noted

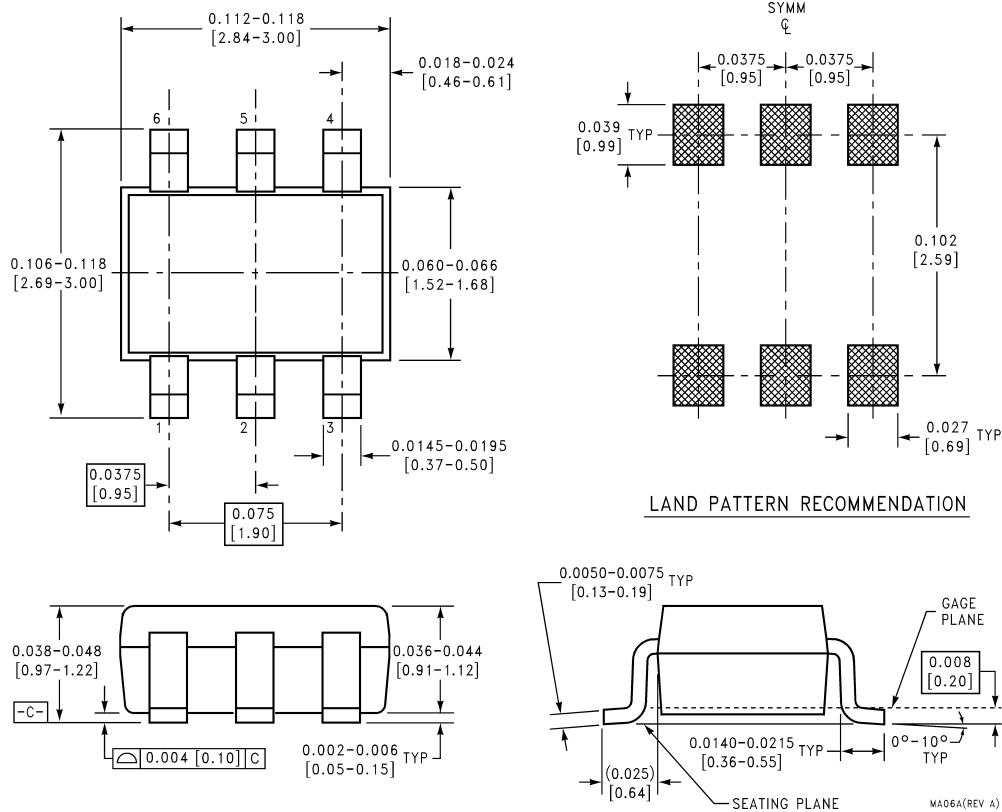

LAND PATTERN RECOMMENDATION

**6-Lead Small Outline Package (M6)
NS Package Number MA06A**

For Order Numbers, refer to the table in the "Ordering Information" section of this document.

LIFE SUPPORT POLICY

NATIONAL'S PRODUCTS ARE NOT AUTHORIZED FOR USE AS CRITICAL COMPONENTS IN LIFE SUPPORT DEVICES OR SYSTEMS WITHOUT THE EXPRESS WRITTEN APPROVAL OF THE PRESIDENT OF NATIONAL SEMICONDUCTOR CORPORATION. As used herein:

1. Life support devices or systems are devices or systems which, (a) are intended for surgical implant into the body, or (b) support or sustain life, and whose failure to perform when properly used in accordance with instructions for use provided in the labeling, can be reasonably expected to result in a significant injury to the user.
2. A critical component is any component of a life support device or system whose failure to perform can be reasonably expected to cause the failure of the life support device or system, or to affect its safety or effectiveness.



National Semiconductor Corporation
Americas
Tel: 1-800-272-9959
Fax: 1-800-737-7018
Email: support@nsc.com

National Semiconductor Europe
Fax: +49 (0) 1 80-530 85 86
Email: europe.support@nsc.com
Deutsch Tel: +49 (0) 1 80-530 85 85
English Tel: +49 (0) 1 80-532 78 32
Français Tel: +49 (0) 1 80-532 93 58
Italiano Tel: +49 (0) 1 80-534 16 80

National Semiconductor Asia Pacific Customer Response Group
Tel: 65-2544466
Fax: 65-2504466
Email: sea.support@nsc.com

National Semiconductor Japan Ltd.
Tel: 81-3-5639-7560
Fax: 81-3-5639-7507

www.national.com

Copyright © Each Manufacturing Company.

All Datasheets cannot be modified without permission.

This datasheet has been download from :

www.AllDataSheet.com

100% Free DataSheet Search Site.

Free Download.

No Register.

Fast Search System.

www.AllDataSheet.com