

Contents

Features	1
Applications	1
Block Diagram	1
Pin Assignment	2
Absolute Maximum Ratings	2
Electrical Characteristics	2
Test Circuits	3
Operation Timing Chart	4
Dimensions	4
Markings	4
Taping	5
Operation	6
Selection of External Parts	10
Standard Circuits	12
Merits in Designing	12
Notes on Design	12
Application Circuits	14
Characteristics	15

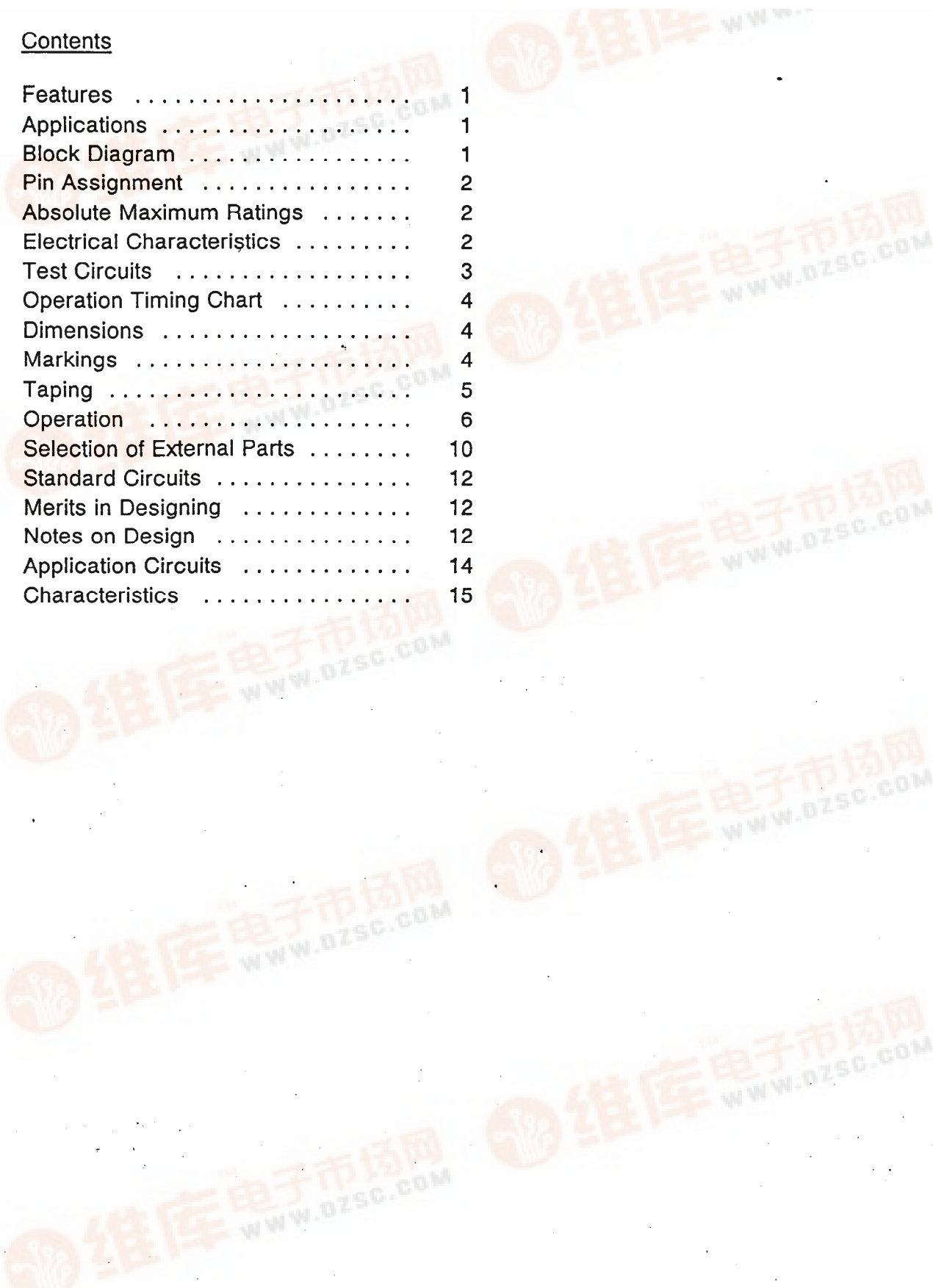

STEP UP & DOWN VOLTAGE REGULATOR

S-8430AF

The S-8430AF is a chopper-type DC/DC converter made using the CMOS process. It automatically steps the voltage up and down according to the input voltage. When the input voltage is higher than the output voltage, the S-8430AF operates as a series regulator. When the input voltage is lower than the output voltage, it operates as a combination of a step-up switching regulator and a series regulator. The output voltage for normal operation can be selected from either 5 V or 3 V and the output level during shutdown can be selected from either the V_{SS} level or the input voltage level.

■ Features

- Low current consumption Operation : $11 \mu\text{A}$ typ.
Shutdown : $0.2 \mu\text{A}$ max.
- Low voltage operation: 0.9 V min.
- Output voltage: 5 V or 3 V
- High precision output voltage: $5 \text{ V} \pm 4\%$ or $3 \text{ V} \pm 5\%$
- Shutdown function
Output voltage during shutdown: $= V_{SS}$ or $= \text{input voltage}$
- Built-in CR oscillation circuit
Oscillating frequency: 40 kHz typ.
- Few external parts because of built-in Schottky diode
- 8-pin SOP package

■ Applications

- Camera
- Pager
- Handy copier
- Handy terminal
- Other battery-driven equipment

■ Block Diagram

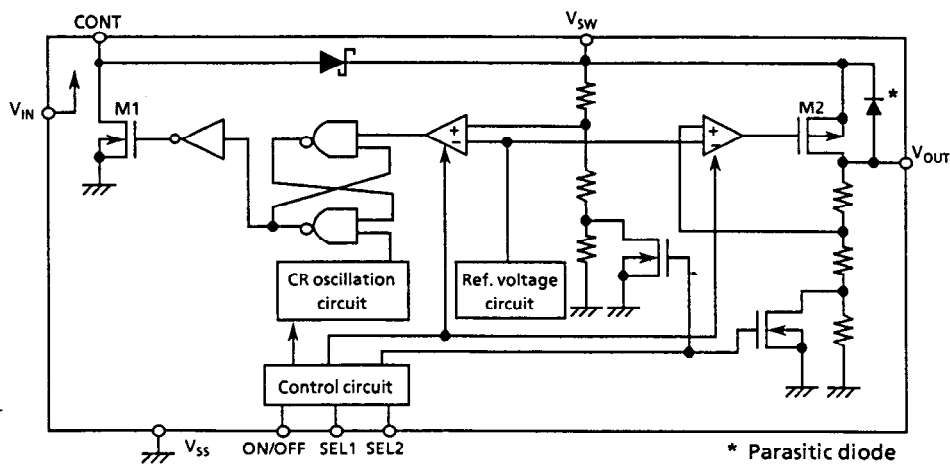
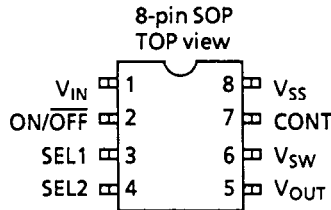

Figure 1

STEP UP & DOWN VOLTAGE REGULATOR S-8430AF

Pin Assignment



No.	Name	Description
2	ON/OFF	Shutdown H: Normal operation L: Shutdown
3	SEL1	Selects output voltage during shutdown H: V _{OUT} = V _{IN} , L: V _{OUT} = V _{SS}
4	SEL2	Selects normal operation output voltage H: V _{OUT} = 5 V, L: V _{OUT} = 3 V
7	CONT	Output driver for external inductor
5	V _{OUT}	Output voltage
6	V _{SW}	Switching regulator output
1	V _{IN}	Positive power supply input
8	V _{SS}	GND

Figure 2

Absolute Maximum Ratings

Table 1

(Unless otherwise specified : T_a = 25°C)

Parameter	Symbol	Conditions	Ratings	Unit
Input voltage	V _{IN}		12	V
Output voltage of switching regulator	V _{SW}		V _{SS} -0.3 to 12	V
Output voltage	V _{OUT}		V _{SS} -0.3 to V _{SW} + 0.3	V
Input pin voltage		ON/OFF, SEL1, SEL2, CONT	V _{SS} -0.3 to 12	V
Power dissipation	P _D		300	mW
Operating temperature	T _{opr}		-30 to +80	°C
Storage temperature	T _{stg}		-40 to +125	°C

Electrical Characteristics

Table 2

(Unless otherwise specified : T_a = 25°C)

Parameter	Symbol	Conditions	Min.	Typ.	Max.	Unit	Test circuit
Input voltage	V _{IN}		—	—	10.0	V	1
Output voltage*	V _{OUT1}	V _{IN} = 2 V, I _{OUT} = 30 mA SEL2 = L, ON/OFF = H	2.85	3.00	3.15	V	1
	V _{OUT2}	V _{IN} = 3 V, I _{OUT} = 30 mA SEL2 = ON/OFF = H	4.80	5.00	5.20	V	1
Current consumption	I _{SS}	V _{IN} = 3 V, Unloaded, SEL1 = SEL2 = ON/OFF = H	—	11	25	μA	2
Shutdown current	I _{SSS1}	V _{IN} = 7 V, Unloaded SEL1 = SEL2 = H, ON/OFF = L	—	—	2.0	μA	3
	I _{SSS2}	V _{IN} = 7 V, Unloaded SEL1 = L, SEL2 = H, ON/OFF = L	—	—	0.2	μA	3
Oscillating frequency	f _{OSC}	V _{IN} = 3 V	20	40	70	kHz	4
Line regulation	$\frac{\Delta V_{OUT}}{\Delta V_{IN} \cdot V_{OUT}}$	V _{IN} = 3 to 10 V, I _{OUT} = 30 mA, SEL2 = H	—	0.1	0.2	%/V	1
		V _{IN} = 2 to 10 V, I _{OUT} = 30 mA, SEL2 = L	—	0.1	0.2	%/V	1
Load regulation	ΔV_{OUT}	V _{IN} = 3 V, I _{OUT} = 50 μA to 30 mA, SEL2 = H	—	20	80	mV	1
		V _{IN} = 2 V, I _{OUT} = 50 μA to 30 mA, SEL2 = L	—	20	80	mV	1
Temperature coefficient of V _{OUT}	$\frac{\Delta V_{OUT}}{\Delta T_a}$	T _a = -30°C to 80°C, SEL2 = H or L	—	± 0.38	—	mV/°C	—
Switching current	I _{SW}	V _{DS} = 0.2 V, SEL2 = H	—	250	—	mA	—
Leakage current of switching transistor	I _{SWQ}	V _{DS} = 10 V	—	—	1.0	μA	6
Input voltage for ON/OFF, SEL1, and SEL2 pins	V _{SH}	V _{IN} = 3 V, H level	2.4	—	—	V	5
	V _{SL}	V _{IN} = 3 V, L level	—	—	0.4	V	5
Output voltage during shutdown	V _{SOUT1}	V _{IN} = V _{SW} = 7 V, unloaded ON/OFF = L, SEL2 = H	0	—	0.1	V	5
	V _{SOUT2}	SEL1 = H	6.9	—	7.0	V	5
Oscillation duty ratio	f _D	V _{IN} = 3 V	—	50	—	%	—
Operation start voltage	V _{ST}	V _{OUT} ≥ 2 V, unloaded, SEL2 = L	0.9	—	—	V	1

* External parts:

Coil: FL5H101K (100 μH) manufactured by Taiyo Yuden, or equivalent

Diode: D1NS4 manufactured by Shindengen, or equivalent

STEP UP & DOWN VOLTAGE REGULATOR S-8430AF

Test Circuits

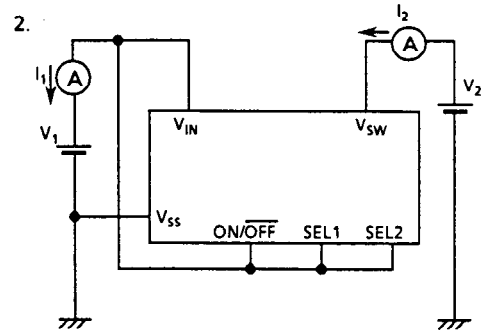
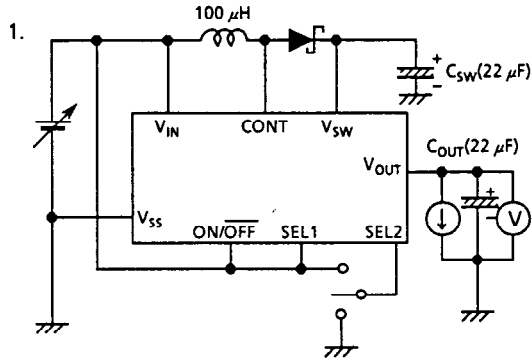

- ① Apply 3 V to V_1 and 5 V to V_2 and measure I_1
- ② Apply 3 V to V_1 and 7 V to V_2 and measure I_2
- ③ $I_S = I_1 + I_2$

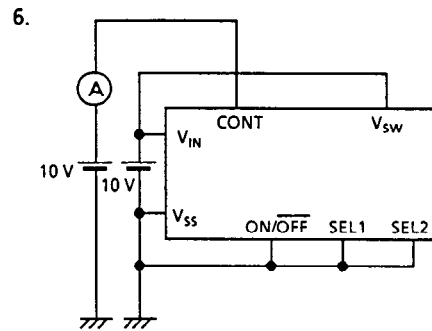
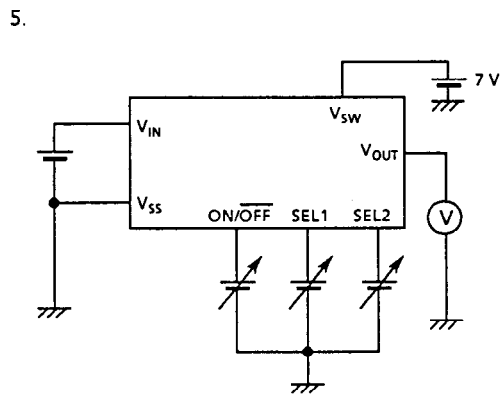
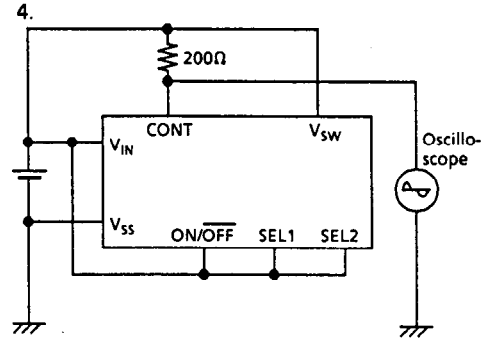
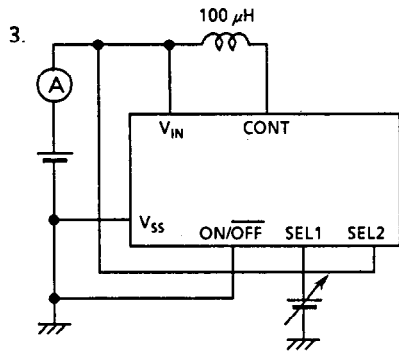

Figure 3

STEP UP & DOWN VOLTAGE REGULATOR S-8430AF

■ Operation Timing Chart

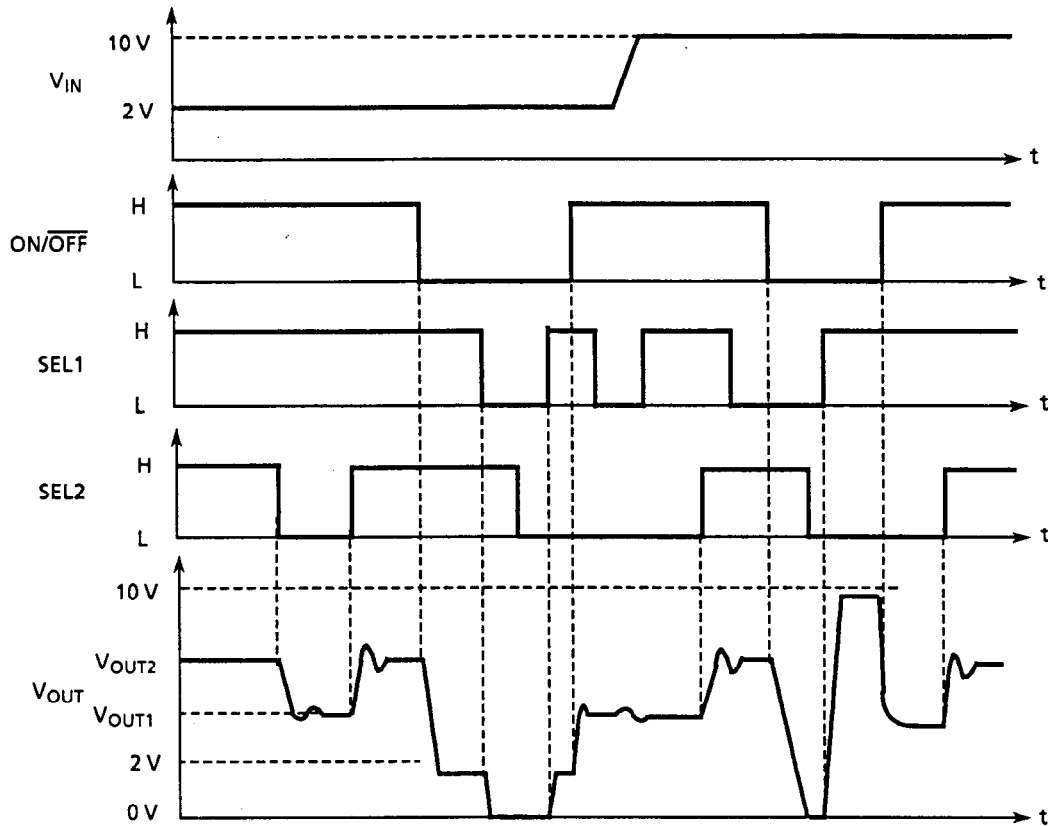
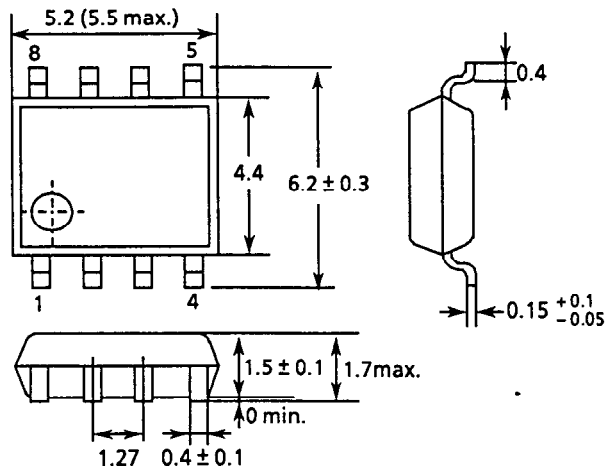

Figure 4

■ Dimensions



Unit : mm

Figure 5

■ Markings

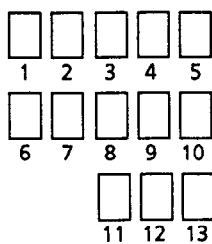

- 1 to 7 : Product name
- 8 : Assembly code
- 9 : Year of assembly (last digit)
- 10 : Month of assembly; Jan. = 1, Feb. = 2, Mar. = 3, Apr. = 4, May = 5, June = 6, July = 7, Aug. = 8, Sept. = 9, Oct. = X, Nov. = Y, Dec. = Z
- 11 to 13: Lot No.

Figure 6

**STEP UP & DOWN VOLTAGE REGULATOR
S-8430AF**

■ **Taping**

1. Tape specifications

T1 and T2 types are available depending upon the direction of ICs on the tape.

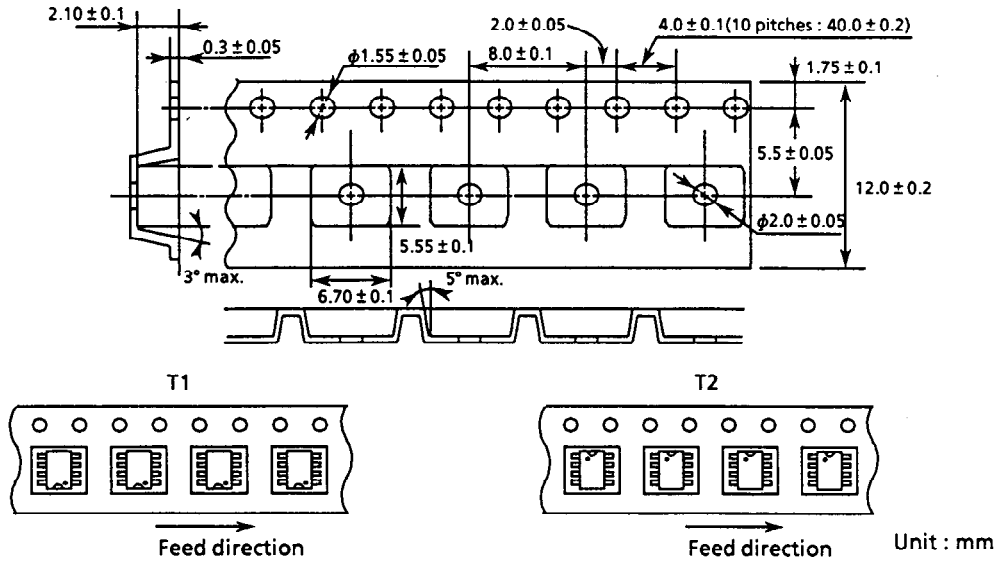

Figure 7

2. Reel specifications

1 reel holds 2000 regulators.

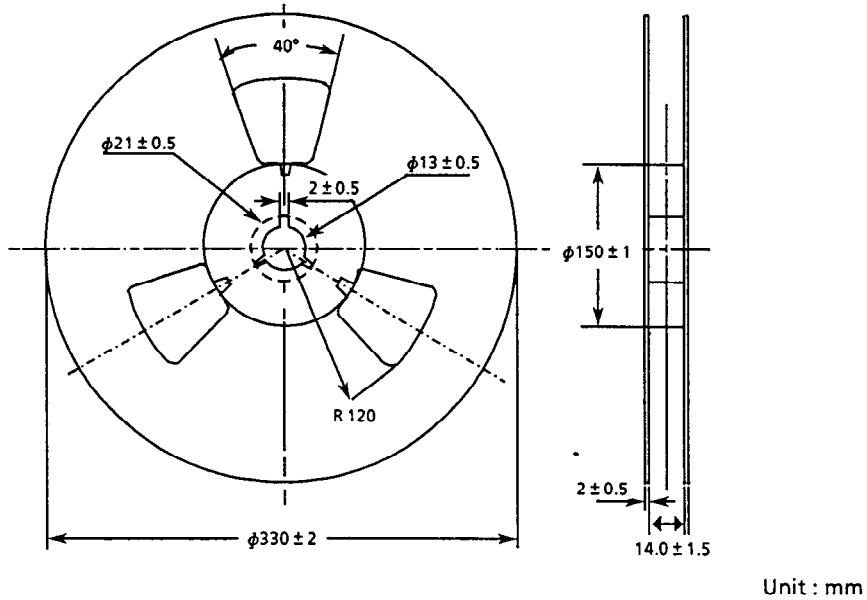

Figure 8

STEP UP & DOWN VOLTAGE REGULATOR S-8430AF

■ Operation

The S-8430AF consists of a switching regulator, a series regulator, and a controller circuit. The switching regulator is cascaded with the series regulator.

1. Control circuit

The S-8430AF has three control pins (ON/ $\overline{\text{OFF}}$, SEL1, and SEL2) that meet the TTL level. These pins control internal circuits. Table 3 shows the statuses and output levels of the control pins.

Table 3

Control pin input			Operation of each circuit block and output status				
ON/ $\overline{\text{OFF}}$ *	SEL1*	SEL2*	Switching regulator	V _{sw} regulation circuit	Series regulator	Output voltage V _{OUT}	Current consumption
H	—	H	Operate	6.25 V ± 4%	5 V	5 V ± 4%	25 μA max.
	—	L	Operate	4.21 V ± 7%	3 V	3 V ± 5%	25 μA max.
L	H	—	Stop	≈ V _{IN} **	Stop	≈ V _{IN} ***	2.0 μA max.
	L	—	Stop	≈ V _{IN} **	Stop	≈ V _{SS}	0.2 μA max.

—: Invalid

* Do not use control pins in floating status, otherwise the output voltage will be unstable.

** Input voltage minus the sum of the voltage reduction due to DC resistance of the inductor and the forward voltage reduction of the diode.

*** Input voltage minus the sum of the voltage reduction due to DC resistance of the inductor, the forward voltage detection of the diode and the voltage reduction of the M2 transistor.

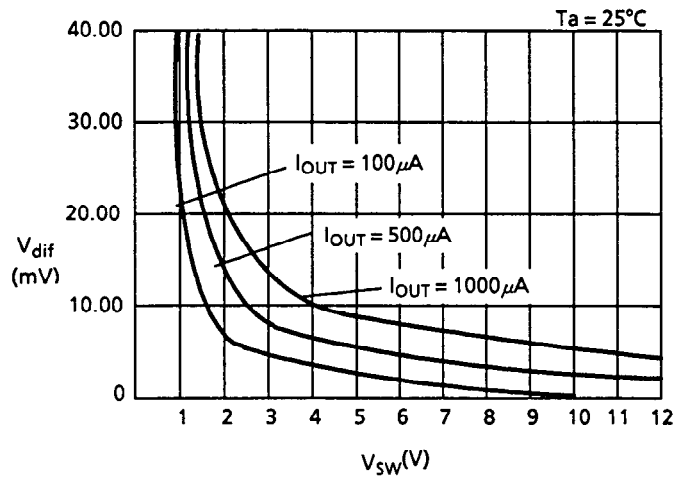

Figure 9 Input/output voltage difference of transistor M2

The ON/ $\overline{\text{OFF}}$ pin controls the operation of the S-8430AF. The S-8430AF operates while the ON/ $\overline{\text{OFF}}$ pin is high, and it's in shutdown status while it is low. During shutdown, internal circuits such as the oscillation circuit, the error amplifier, the reference voltage circuit, and the logic circuit stop and current consumption drops drastically.

The SEL1 pin is enabled only during shutdown. Its output statuses are as described below:

- If the SEL1 pin is low, the V_{SS} level is output.
- If the SEL1 pin is high, the voltage obtained by subtracting the sum of the voltage reduction due to DC resistance of the inductor, the forward voltage reduction of the diode and the voltage reduction of the transistor M2 from the input voltage is output.

The SEL2 pin is enabled only during operation. Its output voltages are as follows:

- If the SEL2 pin is low, 3.0 V ± 5% is output.
- If the SEL2 pin is high, 5.0 V ± 4% is output.

STEP UP & DOWN VOLTAGE REGULATOR S-8430AF

2. Switching regulator

Figure 10 shows a circuit diagram of the switching regulator. The switching regulator consists of the switching transistor (M1), the CR oscillation circuit, and the Schottky diode. The CR oscillation circuit turns M1 on and off. Energy is accumulated in the inductor (L) while M1 is on (t_{ON}). When M1 is turned off, the energy is fed to the capacitor (C_{SW}) of V_{SW} through the diode (Di). For details, see Section 5.

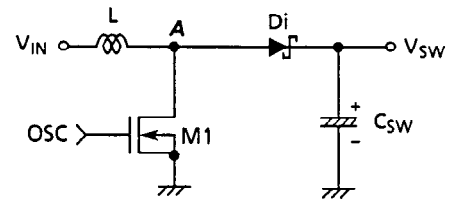

Figure 10 Switching regulator

CR oscillation circuit : A 40-kHz (typ.) oscillator consisting of a capacitor and a resistor. The oscillating frequency fluctuates a little due to changes in the input voltage (V_{IN}) (see ■ Characteristics 14. Oscillating frequency).

Switching transistor (M1) : A large-capacity Nch MOS transistor. Use an inductor whose peak current (I_{PK}) does not exceed 500 mA at room temperature (see ■ Selection of External Parts 1. Inductor).

Schottky diode : This diode has almost the same performance as the 1S1588 small signal diode. To obtain an output current of 10 mA or more (for efficiency), use an external Schottky diode.

V_{SW} voltage : The V_{SW} voltage is adjusted to $6.25\text{ V} \pm 4\%$ when the SEL2 pin is set to high and to $4.21\text{ V} \pm 7\%$ when the SEL2 pin is set to low. The SEL2 pin is valid only when the ON/OFF pin is high.

3. Series regulator

A series regulator installed in the S-8430AF regulates V_{SW} voltage and outputs in V_{OUT} . The output level allows selection of 5 V or 3 V according to the level of the SEL2 pin (see Table 3). The control transistor (M2) for the series regulator is a Pch MOS transistor with a large K value. This allows generation of large output current with only a small difference between input and output voltages.

4. Step-up/down operation with switching regulator and series regulator

4.1 When $V_{IN} < V_{SW}$

When the V_{SW} voltage is less than the adjusted voltage value, V_{IN} is stepped up by the switching regulator and then down by the series regulator, so that the output voltage is stabilized. Figure 11 shows the waveform of the output voltage. In the voltage waveform at the V_{SW} pin, a ripple voltage (V_{PP}) is generated. Through the series regulator, V_{PP} is attenuated as shown in the voltage waveform at the V_{OUT} pin.

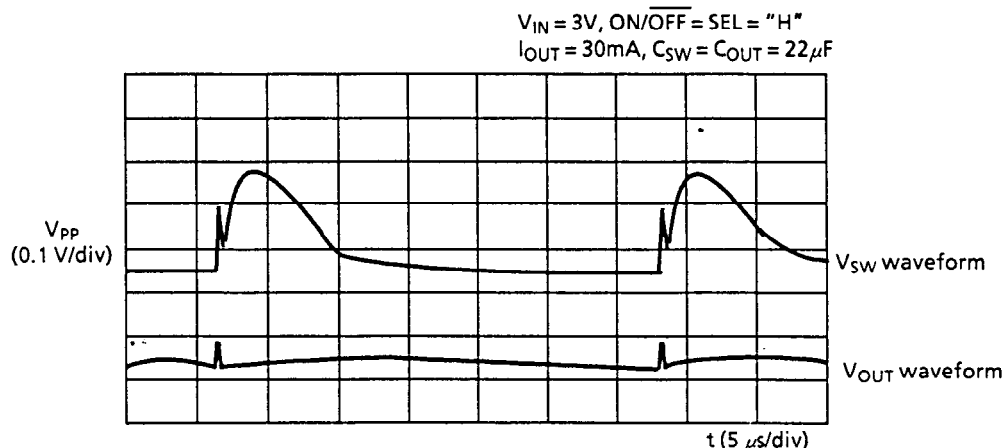

Figure 11

To remove the ripple voltage (V_{PP}) and the spike noise of V_{OUT} , use an external LC filter. However, if I_{OUT} is too small, V_{PP} becomes large.

For reference, examples of the temperature characteristics of the V_{SW} and V_{OUT} pins are shown on the next page.

STEP UP & DOWN VOLTAGE REGULATOR S-8430AF

(1) V_{SW} output

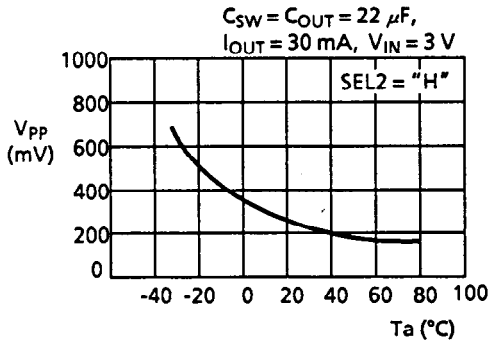

Figure 12

(2) V_{OUT} output

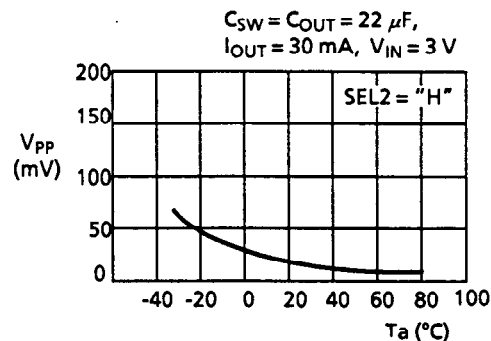

Figure 13

4.2 When $V_{IN} > V_{SW}$

When the V_{SW} voltage [$V_{IN} - (V_L + V_D)$] exceeds the adjusted voltage value, only the series regulator works to stabilize the input voltage.

5. Reference: Basic formula for the switching regulator

This section describes the basic formulas ((1) to (7)) for the step-up switching regulator.

The voltage at A at the instant that M1 is turned on (the current (I_L) flowing in L is zero):

$$V_A = V_S \dots\dots\dots (1)$$

(V_S : Non-saturation voltage of M1)

Change of I_L in time:

$$\frac{I_L}{dt} = \frac{V_L}{L} = \frac{V_{IN} - V_S}{L} \dots\dots\dots (2)$$

Integration (I_L) of the above formula:

$$I_L = \left(\frac{V_{IN} - V_S}{L} \right) \cdot t \dots\dots\dots (3)$$

I_L flows during t_{ON} , which is determined by the oscillation frequency of OSC.

The peak current (I_{PK}) after t_{ON} :

$$I_{PK} = \left(\frac{V_{IN} - V_S}{L} \right) \cdot t_{ON} \dots\dots\dots (4)$$

The energy accumulated in L at that time is expressed by $1/2 L(I_{PK})^2$.

The next time M1 is turned off (t_{OFF}), the energy stored in L is released through the diode (Di), causing a reverse voltage (V_L). V_L is expressed by:

$$V_L = (V_{OUT} + V_D) - V_{IN} \dots\dots\dots (5)$$

(V_D : Forward voltage of diode Di)

The voltage at A rises only as much as the sum of $V_{OUT} + V_D$.

Change of current (I_L) that flows to V_{OUT} through the diode during t_{OFF} in time:

$$\frac{I_L}{dt} = \frac{V_L}{L} = \frac{V_{OUT} + V_D - V_{IN}}{L} \dots\dots\dots (6)$$

Integration of the above formula:

$$I_L = I_{PK} - \left(\frac{V_{OUT} + V_D - V_{IN}}{L} \right) \cdot t \dots\dots\dots (7)$$

STEP UP & DOWN VOLTAGE REGULATOR S-8430AF

During t_{ON} , energy is accumulated in L and is not transferred to V_{OUT} . To obtain a load current (I_{OUT}) from V_{OUT} , the energy in the capacitor (C_{SW}) is used. As a result, the pin voltage of C_{SW} is lowered (to the minimum after t_{ON}). When M1 is turned off, the energy accumulated in L is transferred to C_{SW} through the diode, rapidly increasing the C_{SW} pin voltage. Since V_{OUT} is a time function, V_{OUT} reaches the maximum value (ripple voltage: V_{PP}) when the current flowing to V_{OUT} through the diode matches the constant load current I_{OUT} . The following describes how to calculate the ripple voltage.

I_{OUT} , when the time between t_{ON} and the highest level of V_{OUT} is expressed as t_1 :

$$I_{OUT} = I_{PK} - \left(\frac{V_{OUT} + V_D - V_{IN}}{L} \right) \cdot t_1 \quad \dots\dots\dots (8)$$

$$\therefore t_1 = (I_{PK} - I_{OUT}) \cdot \left(\frac{L}{V_{OUT} + V_D - V_{IN}} \right) \quad \dots\dots\dots (9)$$

Based on (7), since $I_L = 0$ (all the energy in the inductor is released during t_{OFF}):

$$\frac{L}{V_{OUT} + V_D - V_{IN}} = \frac{t_{OFF}}{I_{PK}} \quad \dots\dots\dots (10)$$

Substituting (9) with (10):

$$t_1 = t_{OFF} - \left(\frac{I_{OUT}}{I_{PK}} \right) \cdot t_{OFF} \quad \dots\dots\dots (11)$$

The amount of electric charge ΔQ_1 accumulated in C_{SW} during t_1 is:

$$\begin{aligned} \Delta Q_1 &= \int_0^{t_1} I_L dt = I_{PK} \int_0^{t_1} dt - \left(\frac{V_{OUT} + V_D - V_{IN}}{L} \right) \cdot \int_0^{t_1} t dt \\ &= I_{PK} \cdot t_1 - \left(\frac{V_{OUT} + V_D - V_{IN}}{L} \right) \cdot \frac{1}{2} t_1^2 \quad \dots\dots\dots (12) \end{aligned}$$

Substituting (9) with (12):

$$\Delta Q_1 = I_{PK} - \frac{1}{2} (I_{PK} - I_{OUT}) \cdot t_1 = \frac{I_{PK} + I_{OUT}}{2} \cdot t_1 \quad \dots\dots\dots (13)$$

The voltage (V_{PP}) raised by ΔQ_1 is:

$$V_{PP} = \frac{\Delta Q_1}{C_{SW}} = \frac{1}{C_{SW}} \cdot \left(\frac{I_{PK} + I_{OUT}}{2} \right) \cdot t_1 \quad \dots\dots\dots (14)$$

Taking I_{OUT} consumed during t_1 into consideration:

$$V_{PP} = \frac{\Delta Q_1}{C_{SW}} = \frac{1}{C_{SW}} \cdot \left(\frac{I_{PK} + I_{OUT}}{2} \right) \cdot t_1 - \frac{I_{OUT} \cdot t_1}{C_{SW}} \quad \dots\dots\dots (15)$$

Substituting formula (15) with formula (11):

$$V_{PP} = \frac{(I_{PK} - I_{OUT})^2}{2I_{PK}} \cdot \frac{t_{OFF}}{C_{SW}} \quad \dots\dots\dots (16)$$

STEP UP & DOWN VOLTAGE REGULATOR S-8430AF

■ Selection of External Parts

1. Inductor

To reduce the loss due to the DC resistance, select an inductor with as small an DC resistance as possible (less than 1 Ω). Select the best inductance for the application.

To make the average value of the output voltage (V_{OUT}) constant, the inductor must supply energy equivalent to the output current (I_{OUT}). The amount of charge required for I_{OUT} is $I_{OUT} \times (t_{ON} + t_{OFF})$. The inductor can supply energy only during t_{OFF} , thus the amount of charge is obtained as $I_{PK}/2 \times t_{OFF}$ by integrating formula (7) by $0 \rightarrow t_{OFF}$. Therefore:

$$\frac{I_{PK}}{2} \cdot t_{OFF} = I_{OUT} \times (t_{ON} + t_{OFF}) \quad \dots\dots\dots (17)$$

$$\therefore I_{PK} = 2 \cdot \frac{t_{ON} + t_{OFF}}{t_{OFF}} \cdot I_{OUT} \quad \dots\dots\dots (18)$$

Since the oscillation duty ratio of the OSC is 50% and I_{PK} equals $4 \times I_{OUT}$ if $t_{ON} = t_{OFF}$, the I_{PK} current flowing in the transistor must be four times as much as the required I_{OUT} . I_{PK} is limited due to the characteristics of the M1 transistor (500 mA max.).

In the S-8430AF, recommended inductance is between 30 and 270 μH.

Using an inductor with a large L value decreases I_{PK} and I_{OUT} . Since the energy accumulated in the inductor is $1/2 L(I_{PK})^2$, I_{PK} decreases in steps of squares offsetting the increase of L, and the energy decreases overall. Accordingly, stepping up at low voltages is difficult and the lowest operating voltage must be specified as a high value. However, the DC resistance loss in L and the M1 transistor becomes small because of the reduced I_{PK} , and the efficiency is improved overall.

Using an inductor with a small L value increases I_{PK} and I_{OUT} . Accordingly, the minimum operating voltage is lowered, but efficiency decreases.

Note Too large I_{PK} causes magnetic saturation for some core materials, resulting in destruction of the IC chip. Always keep I_{sat} higher than I_{PK} (I_{sat} : level of current that causes magnetic saturation).

For reference, Table 4 shows the change of drivability due to differences in inductors, measured using output current I_{OUT} as a parameter.

Table 4

Product name	Manufacture	L value	DC resistance	Ref.
FL5H470K	Taiyo Yuden	47 μH	1.37 Ω	A
FL5H101K	Taiyo Yuden	100 μH	2.02 Ω	B
FL5H27AK	Taiyo Yuden	270 μH	4.84 Ω	C
—	(Custom made)	47 μH	0.37 Ω	D
NLC453232	TDK	47 μH	1.45 Ω	E

Condition: $I_{OUT} = 10, 30, 50, 70, 100$ (mA), $T_a = 25^\circ\text{C}$

A

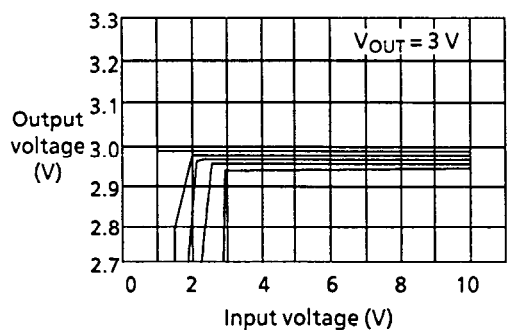
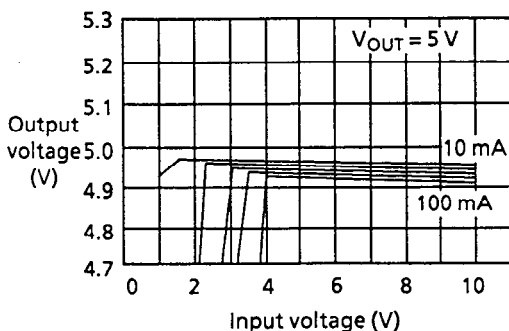

STEP UP & DOWN VOLTAGE REGULATOR S-8430AF

Condition: $I_{OUT} = 10, 30, 50, 70, 100$ (mA), $T_a = 25^\circ\text{C}$

B

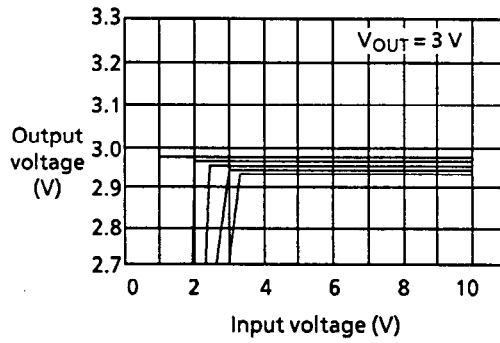
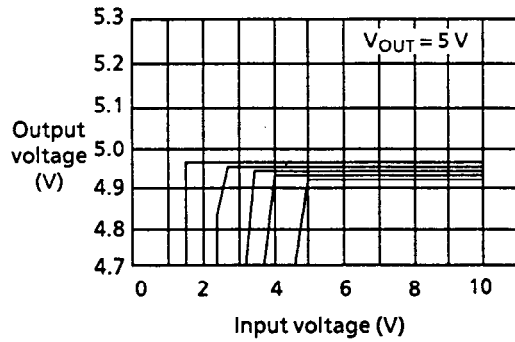

C

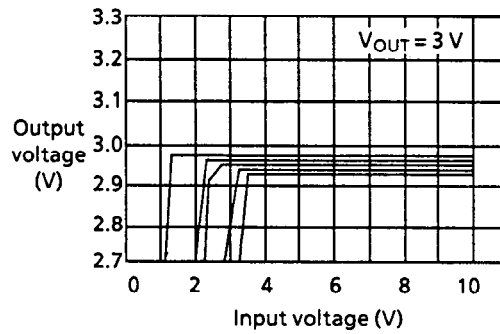
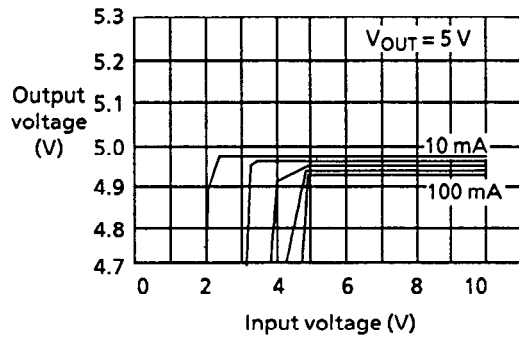

D

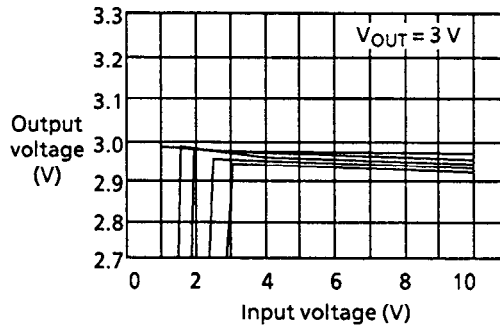
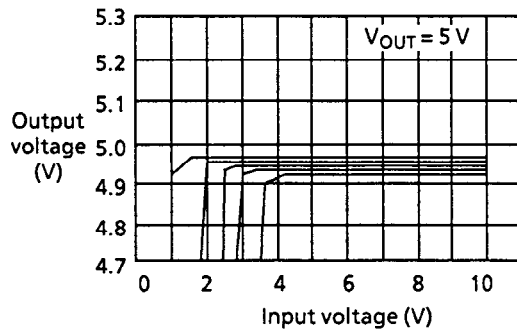

E

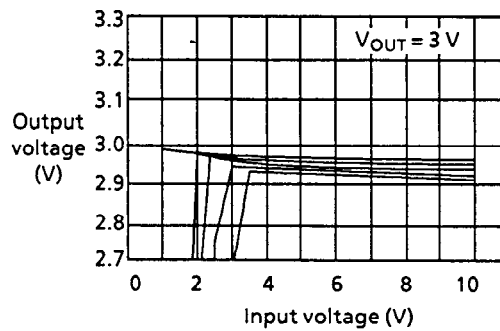
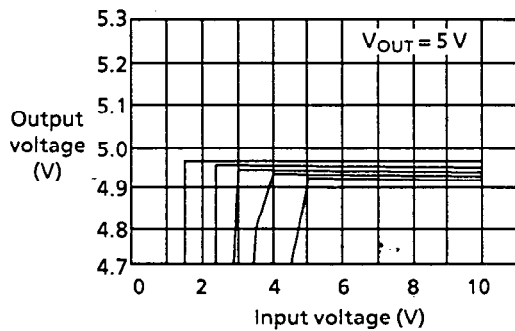

Note Input voltage is measured by 0.5 V step. Graphs from ④ to ⑥ have a few measurement errors.

STEP UP & DOWN VOLTAGE REGULATOR S-8430AF

2. Diode

The S-8430AF has a built-in Schottky diode, which has almost the same performance as the 1S1588 small signal diode (manufactured by Shindengen).

Figure 14 shows the efficiency difference in the temperature characteristics between the D1NS4 and the built-in Schottky diode. The efficiency of the built-in Schottky diode is less than that of the D1NS4 by about 7%.

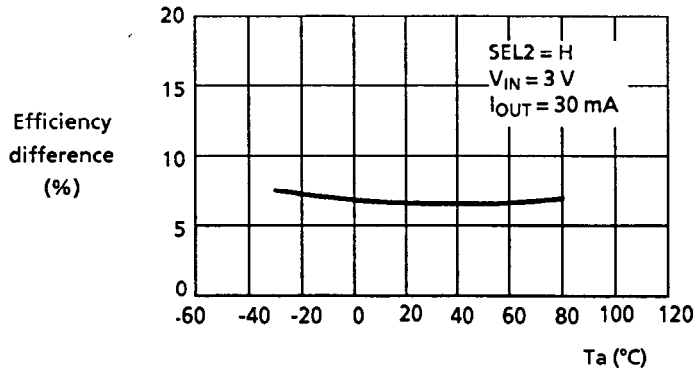

Figure 14

To improve the efficiency to obtain over 10 mA of output current, use an external Schottky diode that has the following characteristics:

- Low forward voltage
- Fast switching rate (500 ns or less. In particular, the recovery time must be short.)
- High backward dielectric strength (low backward leakage current)

3. Rectifying capacitor (C_{SW})

Add a large capacity of capacitor such as an electrolytic capacitor as C_{SW} to the V_{SW} pin. In general, the capacitance of electrolytic capacitors decreases due to low temperature with ripple voltage increasing as a result. Ripple voltage is inversely proportional to the capacitance of rectifying capacitors and to the switching frequency, and is proportional to peak current I_{PK} . Select a capacitor of higher dielectric strength than the values described below as a rectifying capacitor to attenuate the ripple voltage.

- When SEL is H: V_{SW} voltage = 6.5 V max. + ripple voltage
- When SEL is L: V_{SW} voltage = 4.5 V max. + ripple voltage

You can also use a tantalum electrolytic capacitor or an O.S. capacitor, which is superior to an aluminum electrolytic capacitor in low-temperature characteristics and leakage current characteristics.

Standard Circuits

1. When the built-in Schottky diode is used and the output is 5 V

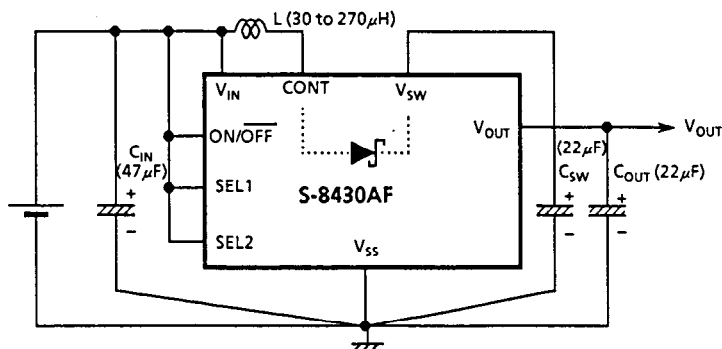

Figure 15

STEP UP & DOWN VOLTAGE REGULATOR S-8430AF

2. When an external Schottky diode is used and the output is 5 V

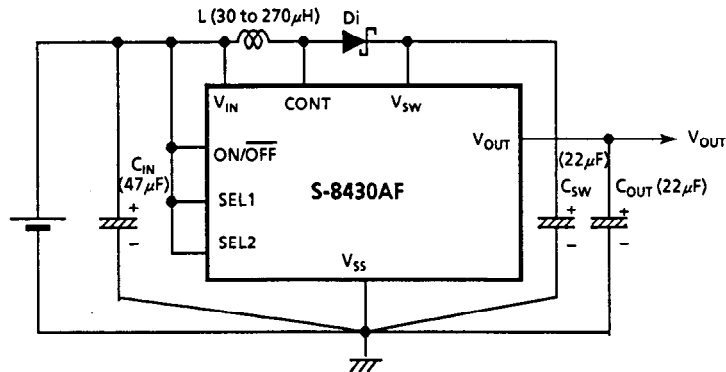

Figure 16

Merits in Designing

When the S-8430AF is used in a power supply circuit of low current consumption that generates about 30 mA of output current, you can structure a system that effectively uses the battery. The reason for this is as follows:

- The output voltage is constant, regardless of the input voltage. This prolongs the operating time ($t_1 \rightarrow t_2$).
- If the input voltage becomes higher than the output voltage, the oscillation circuit of the switching regulator automatically stops. This reduces power consumption.

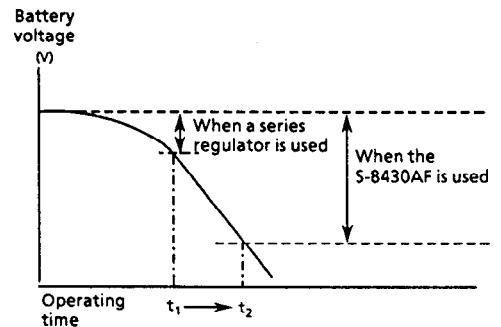

Figure 17

Notes on Design

- In applications where the output current is less than $10 \mu\text{A}$, the output current may rise due to the leak current of the control transistor. This may cause the load stability to be out of the standard. Keep the output current more than $10 \mu\text{A}$.
- Install external capacitors, diodes, and coils as close as possible to the IC chip.
- The switching regulator causes unique ripple voltages and spike noises. To implement a design using the S-8430AF, evaluate the performance with the actual device.
- Consider the tolerable loss of the switching transistor, particularly at high temperature.

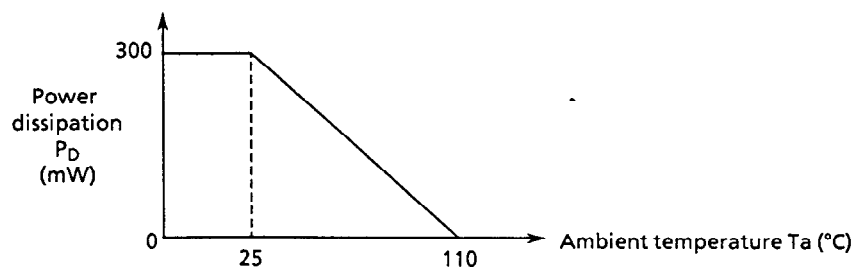

Figure 18 Power dissipation of 8-pin SOP

STEP UP & DOWN VOLTAGE REGULATOR S-8430AF

Application Circuits

1. A power changeover system of 3 V and 5 V

- (1) The fall of input voltage makes automatically the output of the S-8430AF 3 V, and at the same time a microcomputer enters standby mode.

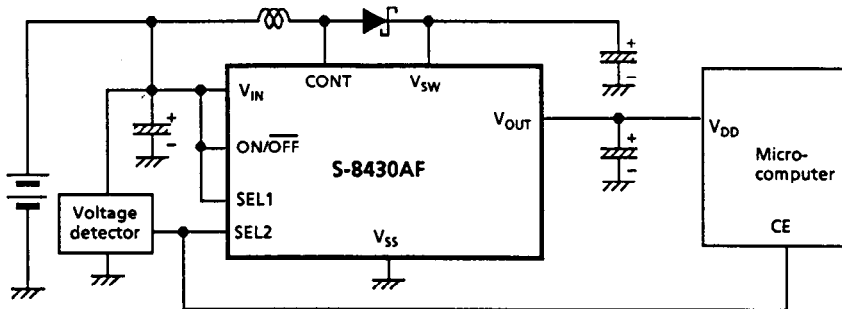

Figure 19

(2) A current consumption reducing system

When operating a 5-V operating microcomputer with 3-V battery, a voltage detector is used to monitor the battery voltage. If the voltage detector detects the fall of the battery voltage, the S-8430AF turns off to save current consumption. Also, unregulated $\approx V_{IN}$ voltage is output to V_{OUT} pin. Therefore, the SRAM data can be kept in backup system.

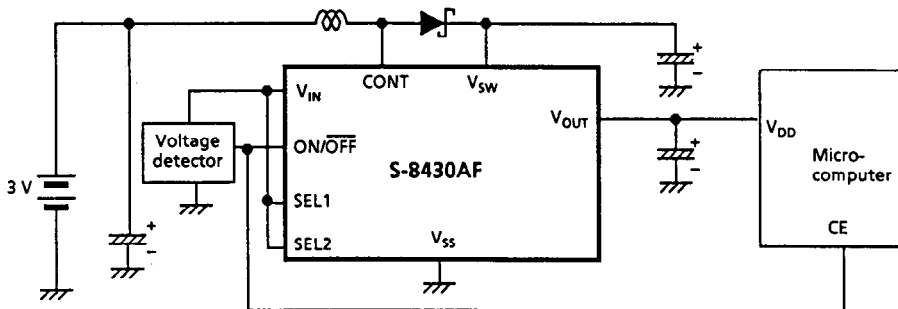

Figure 20

2. When boosting output current

Installing an external bipolar transistor increases the output current. However, efficiency decreases as all base current is consumed.

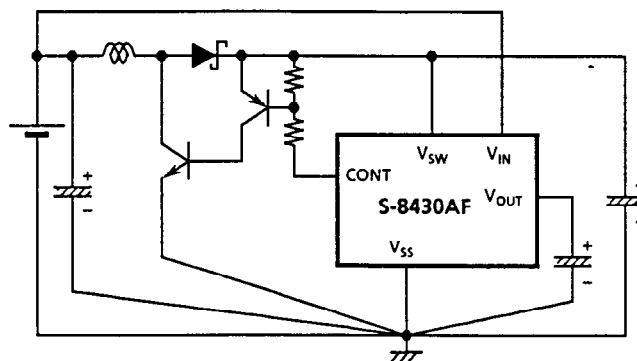

Figure 21

STEP UP & DOWN VOLTAGE REGULATOR S-8430AF

Characteristics

1. Operating current consumption (I_{SS}) – Ambient temperature (T_a)

1.1 $V_{IN} = 3\text{ V}$

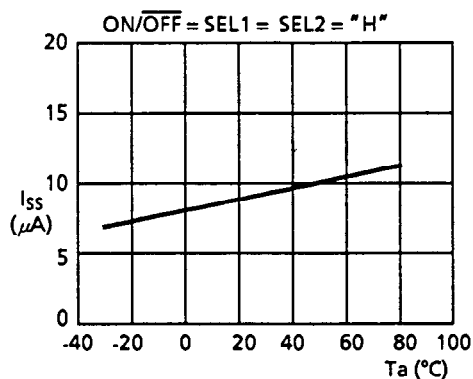

1.2 $V_{IN} = 2\text{ V}$

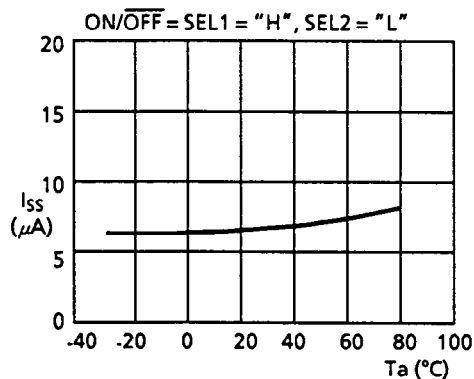

2. Shutdown current (I_{SSS1}) – Ambient temperature (T_a)

$V_{IN} = 7\text{ V}$, ON/OFF = "L", SEL1 = SEL2 = "H"

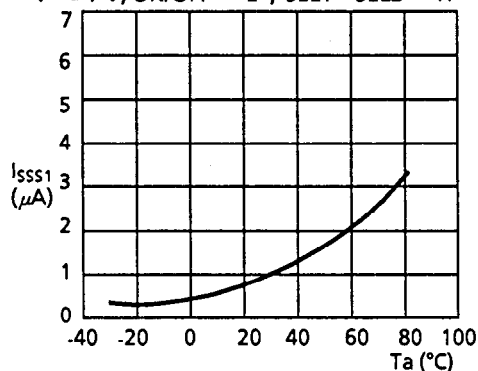

3. Shutdown current (I_{SSS2}) – Ambient temperature (T_a)

$V_{IN} = 7\text{ V}$, ON/OFF = SEL1 = "L", SEL2 = "H"

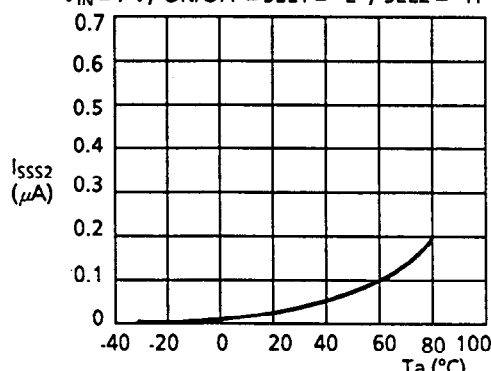

* I_{SSS1} and I_{SSS2} increase with high temperature.

4. Line regulation ($\frac{\Delta V_{OUT}}{\Delta V_{IN} \cdot V_{OUT}}$) – Ambient temperature (T_a)

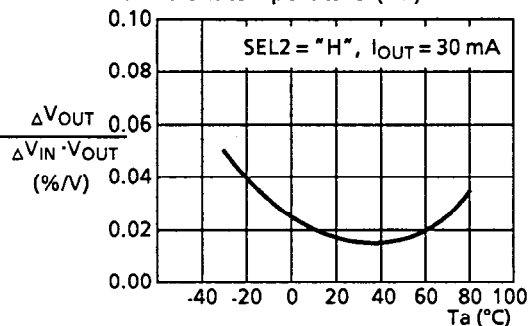

5. Load regulation (ΔV_{OUT}) – Ambient temperature (T_a)

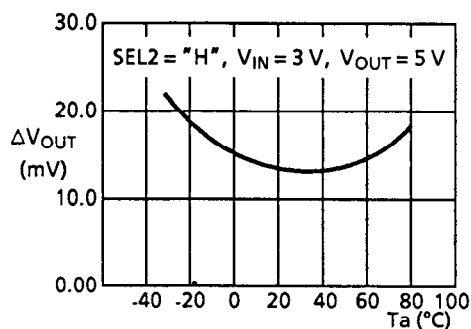

6. Oscillation start voltage (V_{OSC}) – Ambient temperature (T_a)

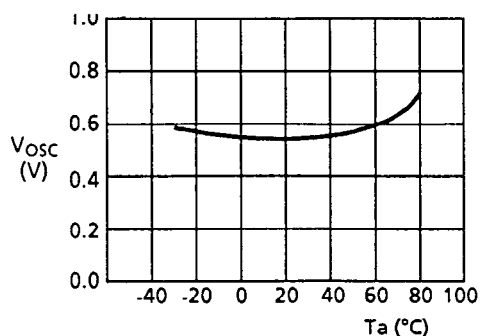

7. Input voltage of ON/OFF, SEL1 & SEL2 pin (V_{SH} , V_{SL}) – Input voltage (V_{IN})

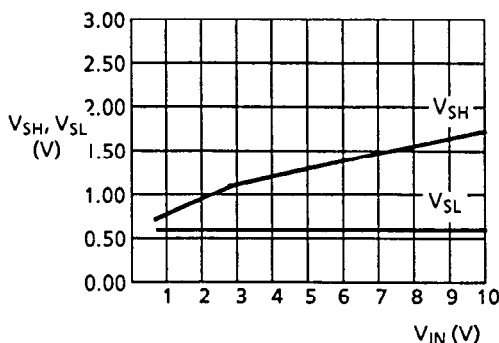

V_{SH} : Lowest voltage recognized as high
 V_{SL} : Highest voltage recognized as low

STEP UP & DOWN VOLTAGE REGULATOR S-8430AF

8. V_{IN} step response

8.1 SEL2 = H, $V_{IN} = 0\text{ V} \rightarrow 3\text{ V}$

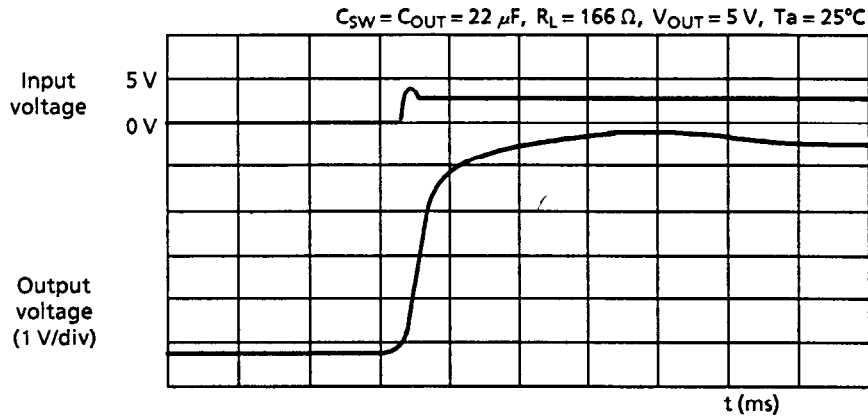

8.2 SEL2 = H, $V_{IN} = 0\text{ V} \rightarrow 10\text{ V}$

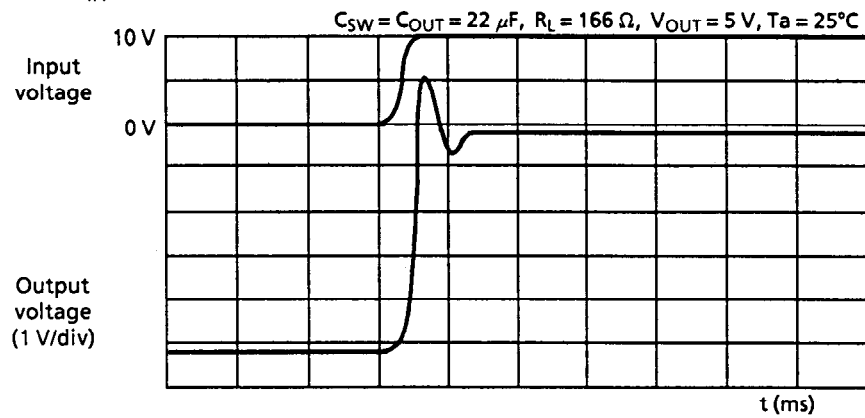

8.3 SEL2 = L, $V_{IN} = 0\text{ V} \rightarrow 2\text{ V}$

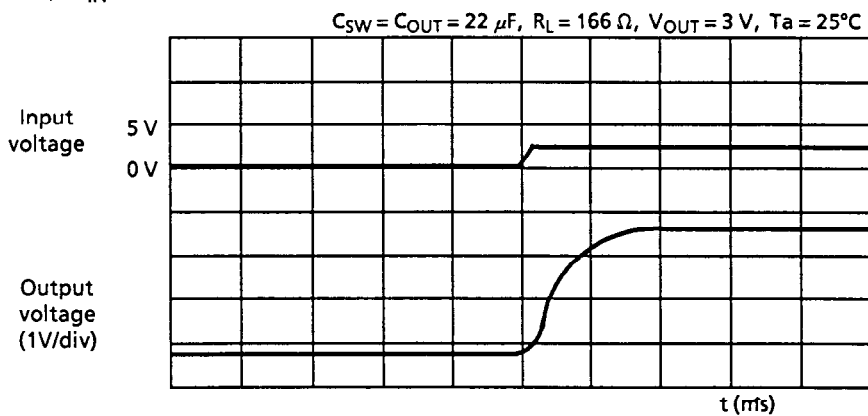

Note Use a capacitor in due consideration of overshooting value to the V_{SW} and V_{OUT} pins, as a ringing occurs in the waveform during the fluctuations of input voltage and output current.

8.4 SEL2 = L, $V_{IN} = 0\text{ V} \rightarrow 10\text{ V}$

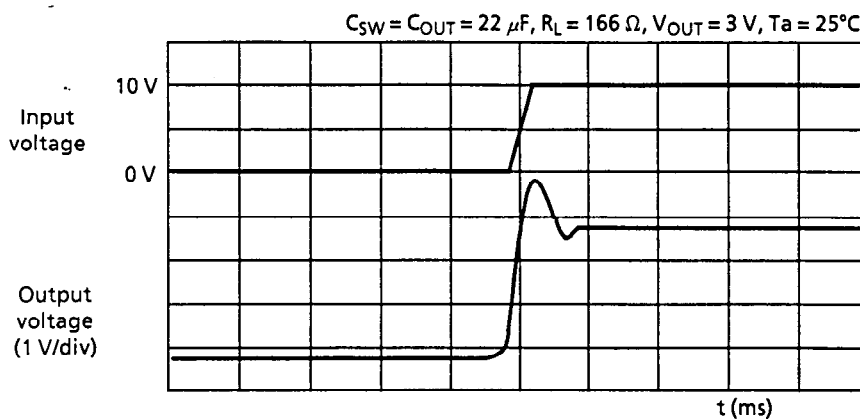

STEP UP & DOWN VOLTAGE REGULATOR S-8430AF

8.5 SEL2 = H, $V_{IN} = 3\text{ V} \leftrightarrow 10\text{ V}$

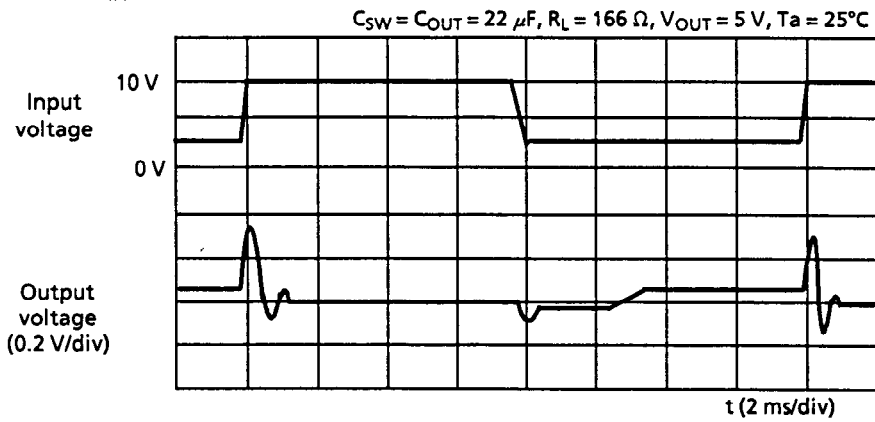

8.6 SEL2 = L, $V_{IN} = 2\text{ V} \leftrightarrow 10\text{ V}$

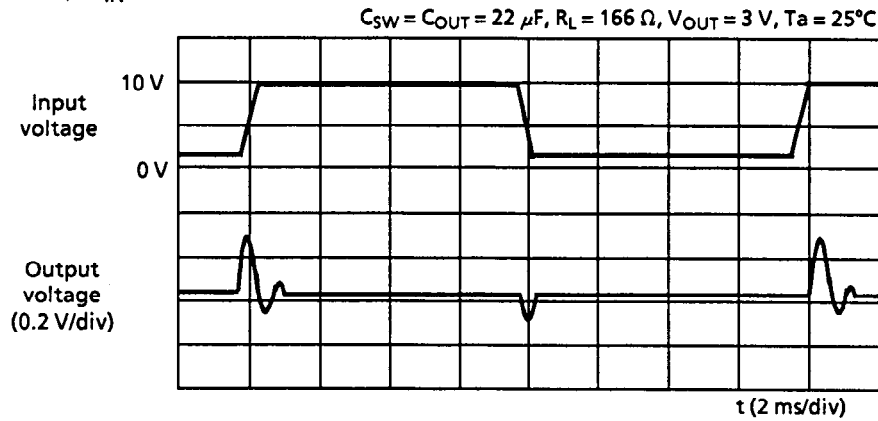

Note When a voltage detector (S-807 Series of Seiko Instruments Inc.) is connected externally to V_{OUT} pin, use one in due consideration of undershooting value.

9. Output current (load current) fluctuation response

9.1 $I_{OUT} = 2\text{ mA} \leftrightarrow 30\text{ mA}$ ON/OFF = SEL1 = SEL2 = H

(a) $V_{IN} = 3\text{ V}$

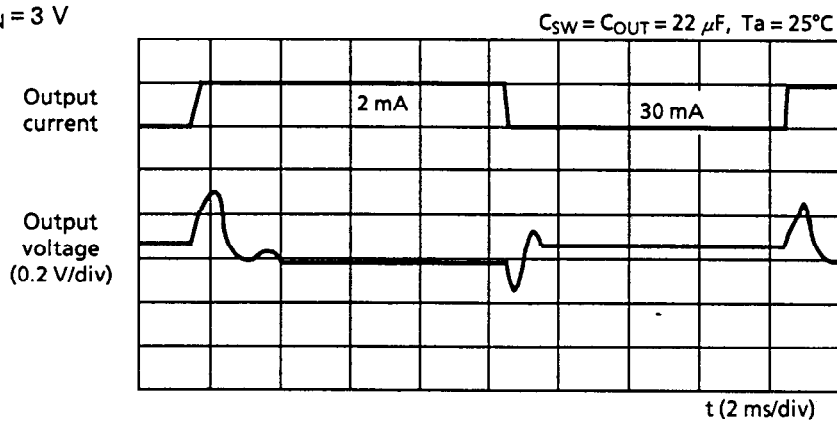

(b) $V_{IN} = 7\text{ V}$

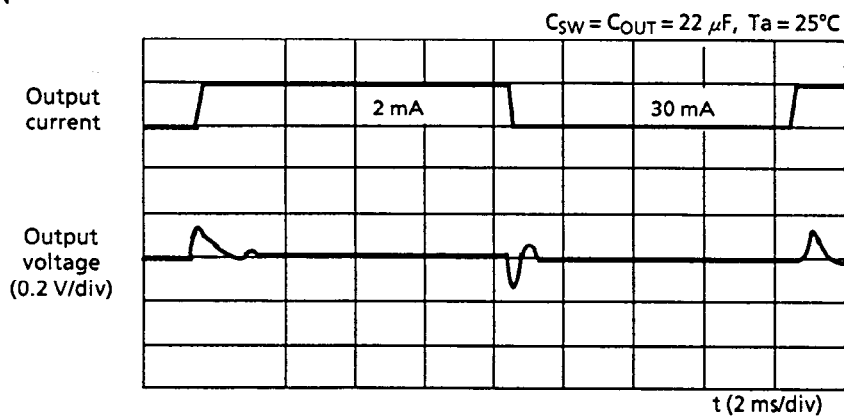

STEP UP & DOWN VOLTAGE REGULATOR S-8430AF

9.2 $I_{OUT} = 1\text{ mA} \leftrightarrow 18\text{ mA}$ $\text{ON}/\overline{\text{OFF}} = \text{SEL1} = \text{H}, \text{SEL2} = \text{H}$

(a) $V_{IN} = 2\text{ V}$

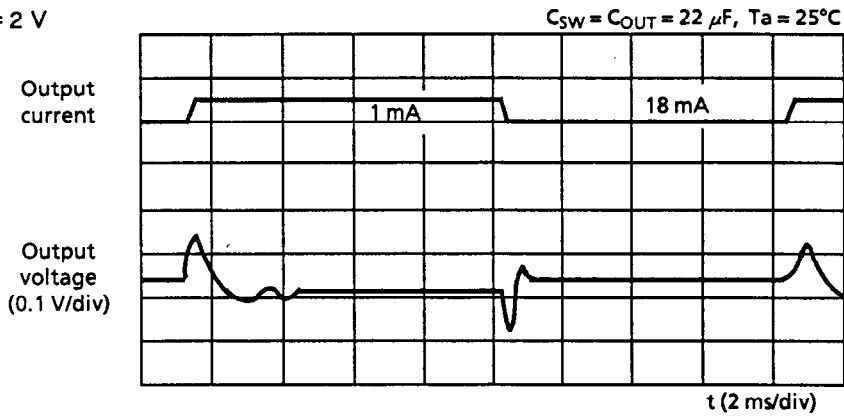

(b) $V_{IN} = 5\text{ V}$

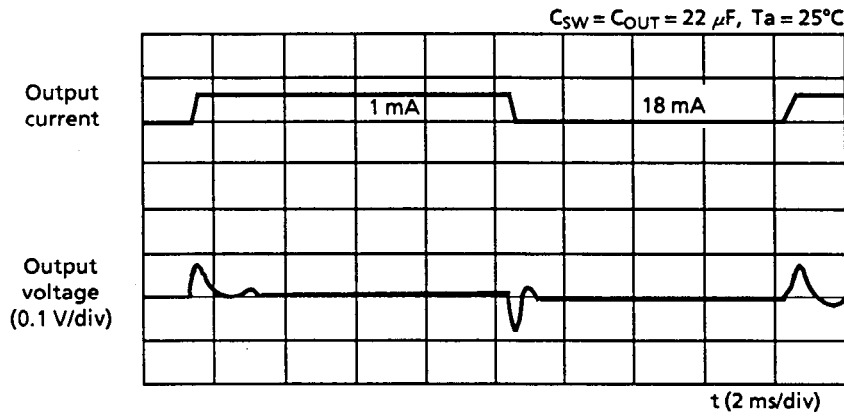

Note If an output current fluctuates in larger scale than the graphs above, larger ringing occurs.

10. $\text{ON}/\overline{\text{OFF}}$ pin response

10.1 $V_{IN} = 3\text{ V}, \text{SEL1} = \text{H}, \text{SEL2} = \text{H}$

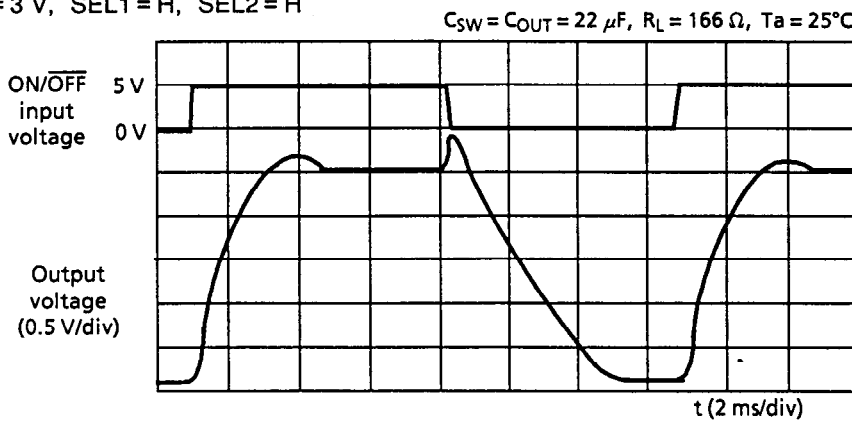

10.2 $V_{IN} = 3\text{ V}, \text{SEL1} = \text{L}, \text{SEL2} = \text{H}$

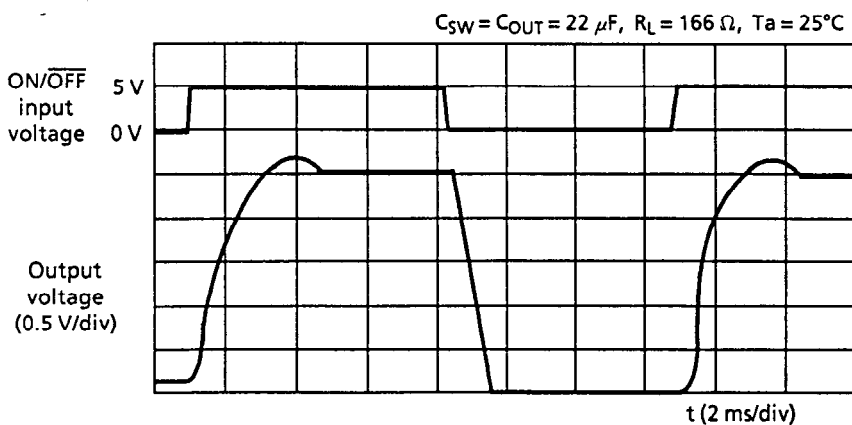

STEP UP & DOWN VOLTAGE REGULATOR
S-8430AF

10.3 $V_{IN} = 3\text{ V}$, SEL1 = H, SEL2 = L

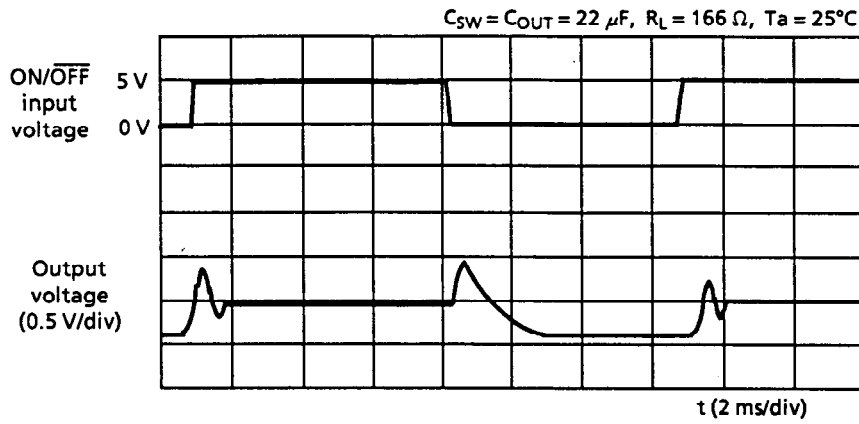

10.4 $V_{IN} = 3\text{ V}$, SEL1 = L, SEL2 = L

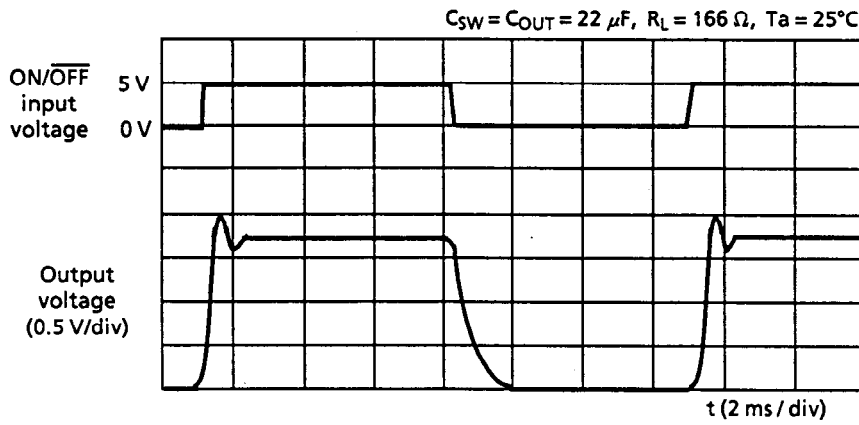

10.5 $V_{IN} = 7\text{ V}$, SEL1 = H, SEL2 = H

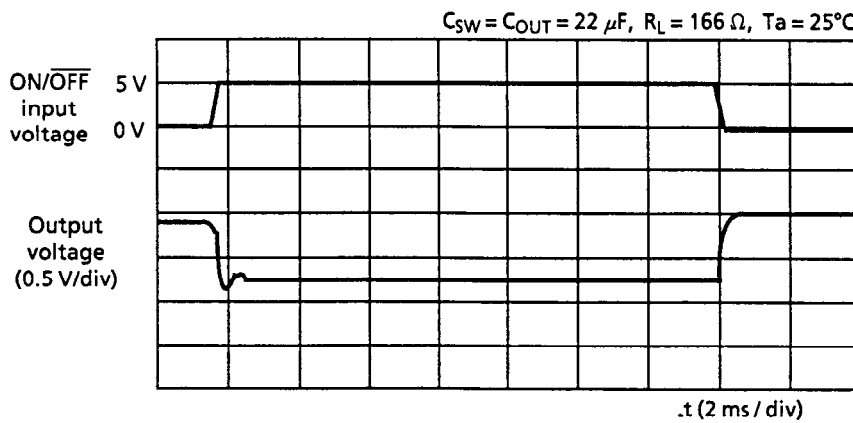

10.6 $V_{IN} = 7\text{ V}$, SEL1 = L, SEL2 = H

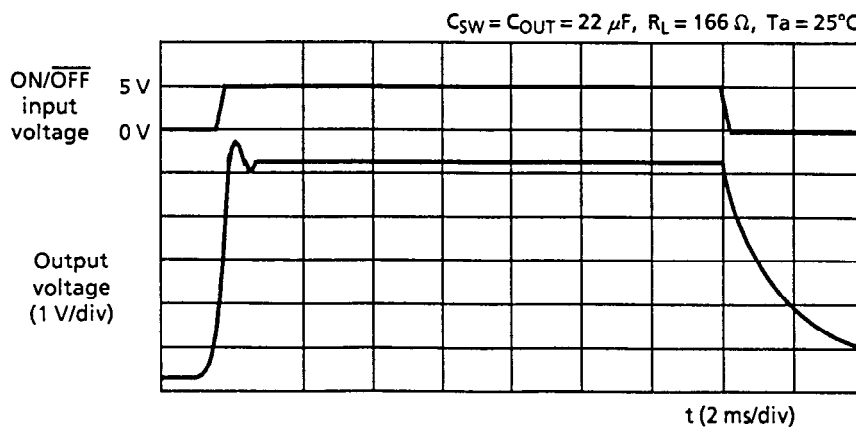

STEP UP & DOWN VOLTAGE REGULATOR S-8430AF

10.7 $V_{IN} = 7\text{ V}$, SEL1 = H, SEL2 = L

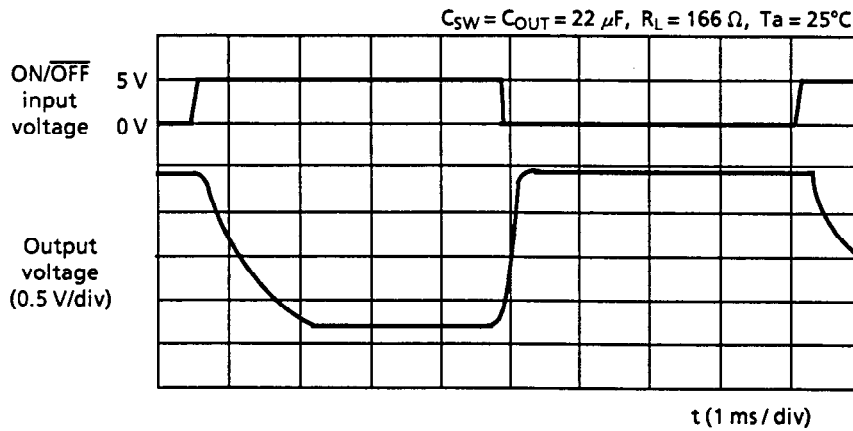

10.8 $V_{IN} = 7\text{ V}$, SEL1 = L, SEL2 = L

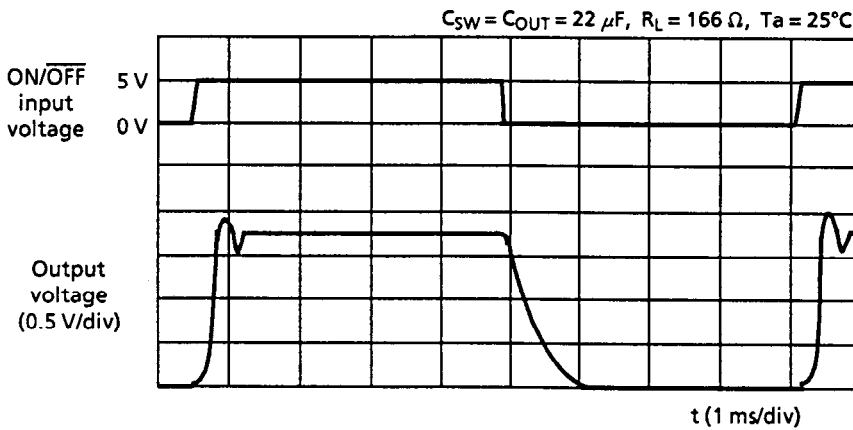

11. SEL1 pin response

11.1 $V_{IN} = 3\text{ V}$, ON/OFF = L, SEL2 = H

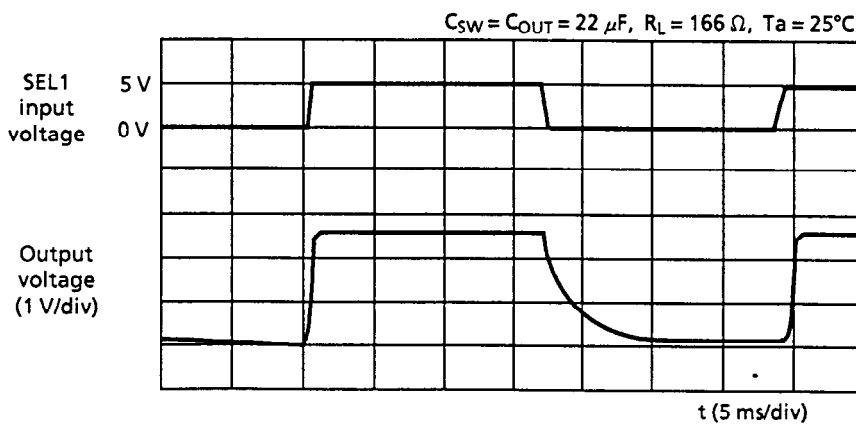

11.2 $V_{IN} = 3\text{ V}$, ON/OFF = L, SEL2 = H

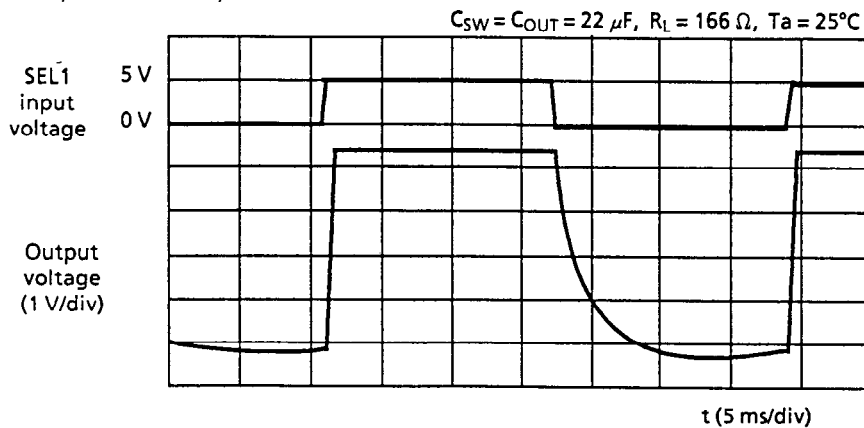

STEP UP & DOWN VOLTAGE REGULATOR S-8430AF

12. SEL2 pin response

12.1 $V_{IN} = 3\text{ V}$, $\overline{\text{ON/OFF}} = \text{H}$, $\text{SEL1} = \text{H}$

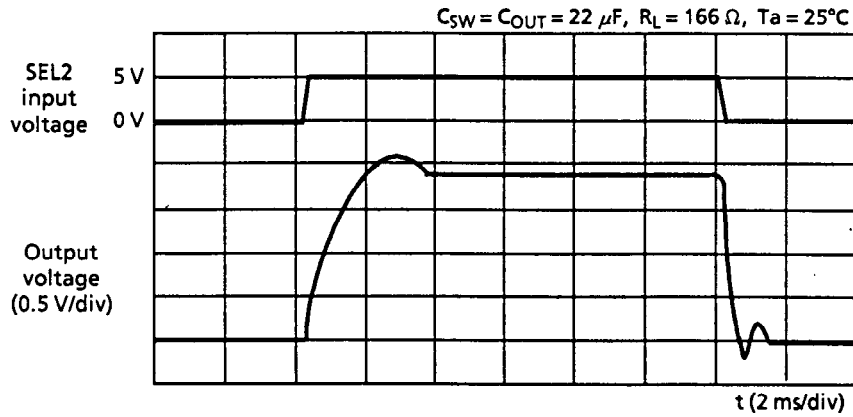

12.2 $V_{IN} = 7\text{ V}$, $\overline{\text{ON/OFF}} = \text{H}$, $\text{SEL1} = \text{H}$

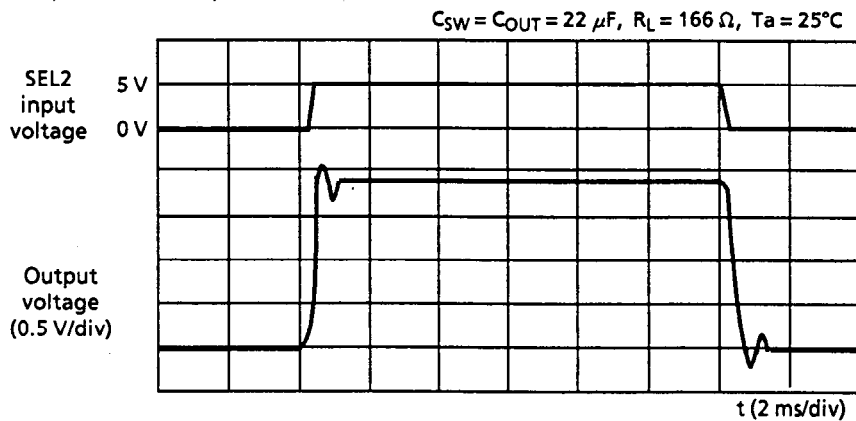

13. Efficiency- temperature (in case of using $L = 100\ \mu\text{H}$ (FL5H101K), Di : D1NS4)

13.1 V_{SW} pin (Output of switching regulator)

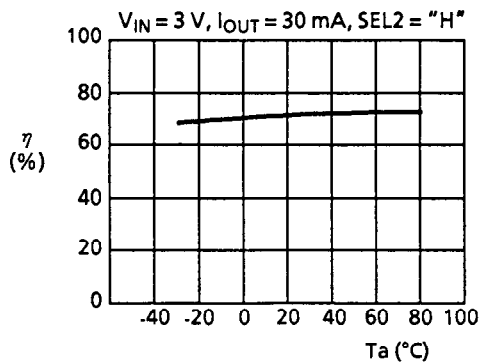

13.2 V_{OUT} pin (Output of whole IC)

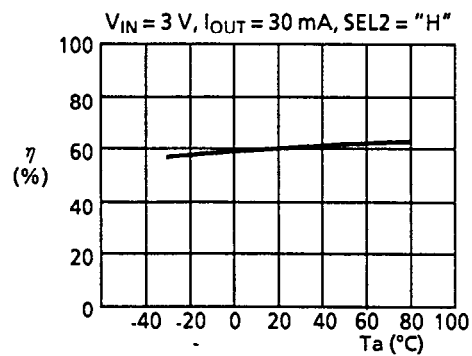

Note: The efficiency is fluctuated by an inductor of diode. And the total efficiency falls for series regulator.

14. Oscillating frequency

14.1 Input voltage (V_{IN})

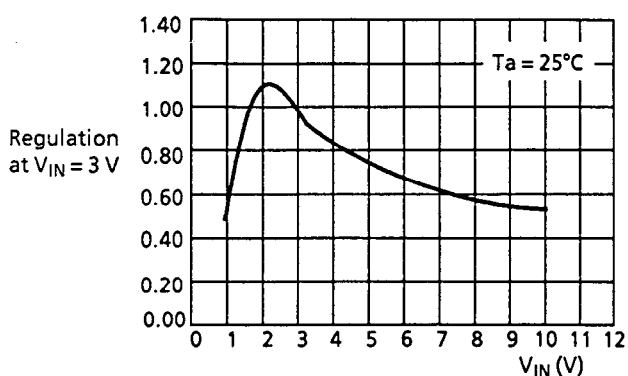

14.2 Temperature (T_a)

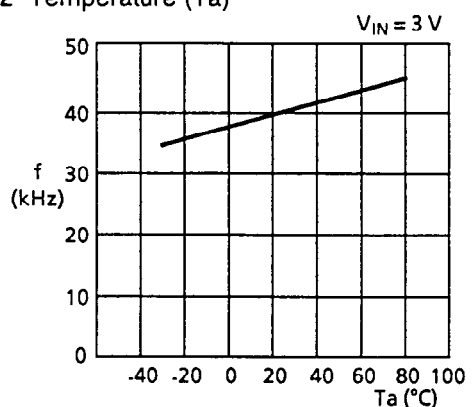

STEP UP & DOWN VOLTAGE REGULATOR

S-8430AF

15. Output voltage of the switching regulator (V_{SW}) – Temperature

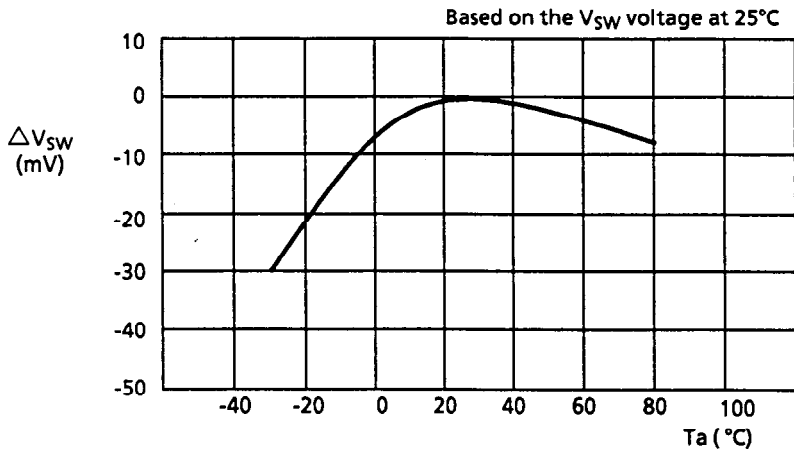

16. Output voltage (V_{OUT}) – Ambient temperature (T_a)

16.1 $V_{OUT} = 3\text{ V}$

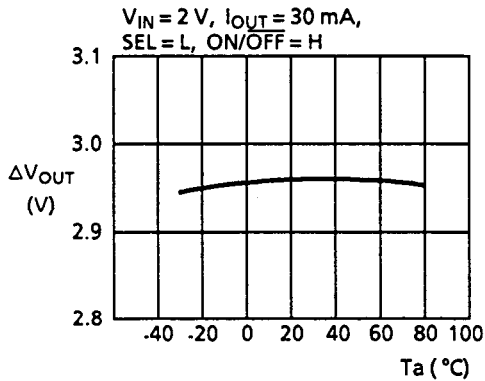

16.2 $V_{OUT} = 5\text{ V}$

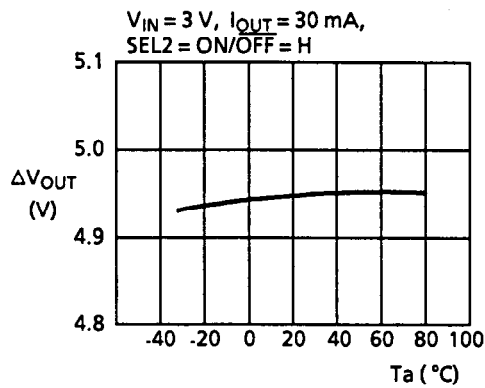

17. Output current in the minimum input voltage (I_{OUT}) – Output voltage (V_{OUT})

17.1 $V_{OUT} = 3\text{ V}$, SEL = L, ON/OFF = H

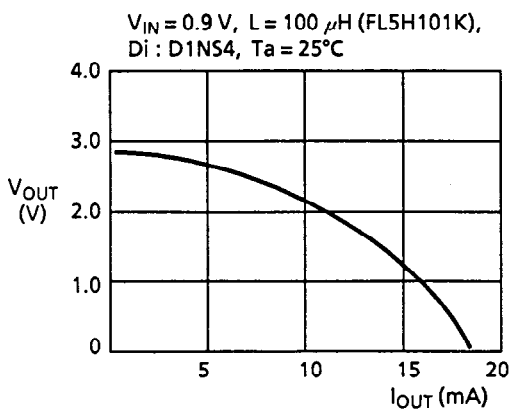

17.2 $V_{OUT} = 5\text{ V}$, SEL2 = ON/OFF = H

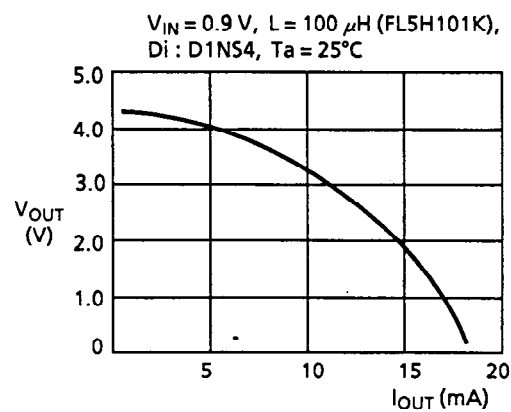

18. Rising/falling time of switching transistor (M1)

18.1 Rising time (t_{ON}) – Ambient temperature (T_a)

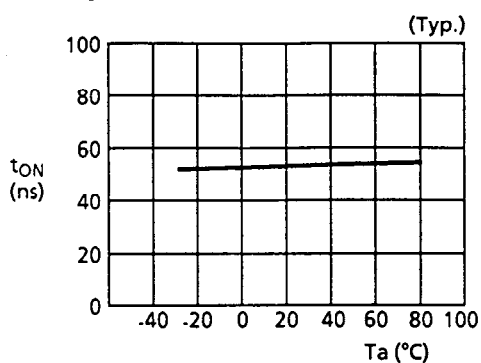

18.2 Falling time (t_{OFF}) – Ambient temperature (T_a)

