



**Part Number 855833**

**1880 MHz SAW Split Band Filter**

**Data Sheet**

**Features**

- For PCS applications
- Usable bandwidth 30 MHz (each band)
- Low loss
- No impedance matching required for operation at 50 Ω
- Single-ended operation
- Ceramic Surface Mount Package (SMP)
- Small size

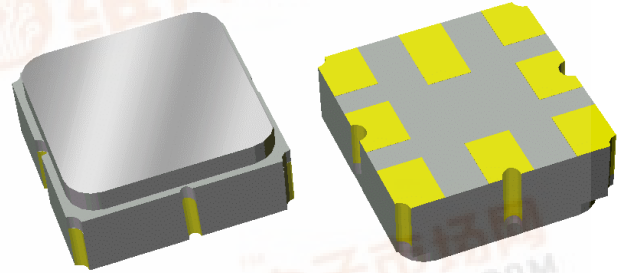

**Package**

Surface Mount 3.0 x 3.0 x 1.22 mm

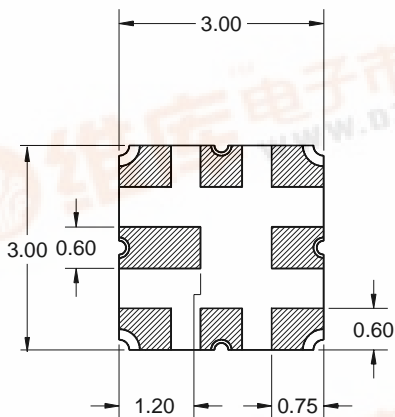
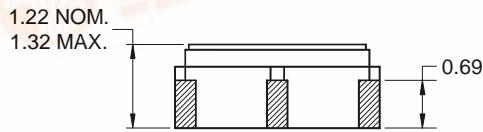

**Pin Configuration**

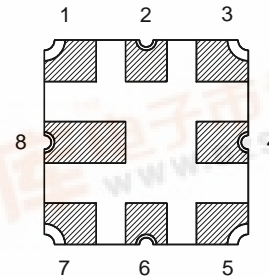

Pad No.	Description
1	Input band #1
3	Input band #2
5	Output band #2
7	Output band #1
2,4,6,8	Case ground

Dimensions shown are nominal in millimeters  
 All tolerances are ±0.15mm except overall length and width ±0.10mm

Body:  $Al_2O_3$  ceramic  
 Lid: Kovar, Ni plated

Terminations: Au plating 0.5 - 1.0µm,  
 over a 2 - 6µm Ni plating



**Data Sheet**

**Band #1 Electrical Specifications <sup>(1)</sup>**

Operating Temperature Range: <sup>(2)</sup> -40 to +85 °C

Parameter <sup>(3)</sup>	Minimum	Typical	Maximum	Unit
<b>Center Frequency</b>	-	1865	-	MHz
<b>Maximum Insertion Loss</b> 1850 - 1880 MHz	-	2	2.5	dB
<b>Passband Ripple</b> 1850 - 1880 MHz	-	0.4	1.5	dB p-p
<b>Absolute Attenuation</b>				
DC - 1770 MHz	25	28	-	dB
1770 - 1800 MHz	23	38	-	dB
1930 - 1960 MHz	35	40	-	dB
1960 - 2040 MHz	25	33	-	dB
2040 - 2100 MHz	30	34	-	dB
2100 - 3000 MHz	25	34	-	dB
<b>Input/Output Return Loss</b> 1850 - 1880 MHz	10	16.5	-	dB
<b>Terminating Source Impedance: <sup>(4)</sup></b>	-	50	-	Ω
<b>Terminating Load Impedance: <sup>(4)</sup></b>	-	50	-	Ω
<b>Operating Temperature Range</b>	-40	+25	+85	°C

**Notes:**

1. All specifications are based on the test circuit shown below
2. In production, devices will be tested at room temperature to a guardbanded specification to ensure electrical compliance over temperature
3. Electrical margin has been built into the design to account for the variations due to temperature drift and manufacturing tolerances
4. This is the optimum impedance in order to achieve the performance shown

**Band #1 Test Circuit:**

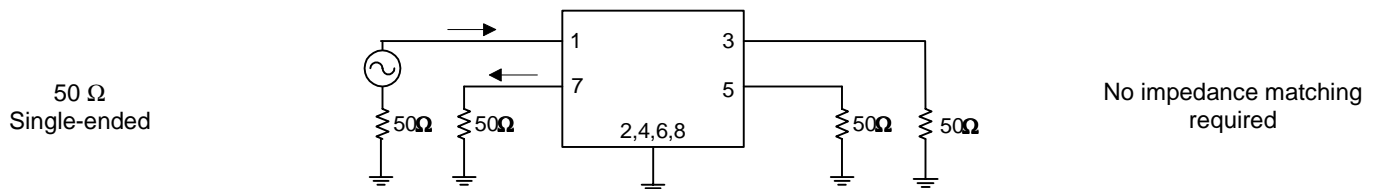

**Data Sheet**

**Band #1 Typical Performance (at +25°C)**

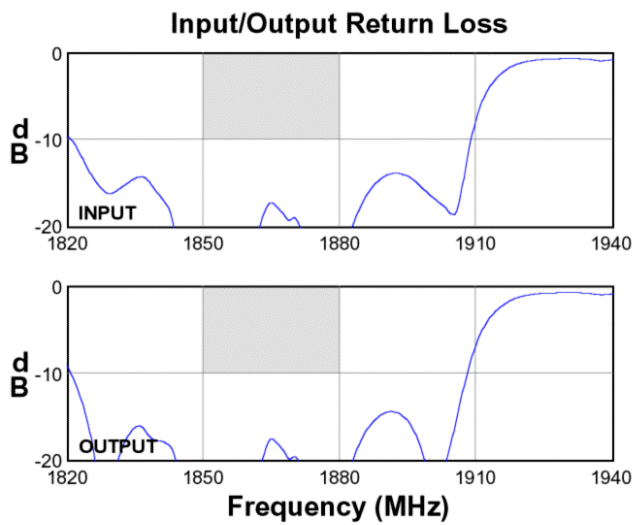
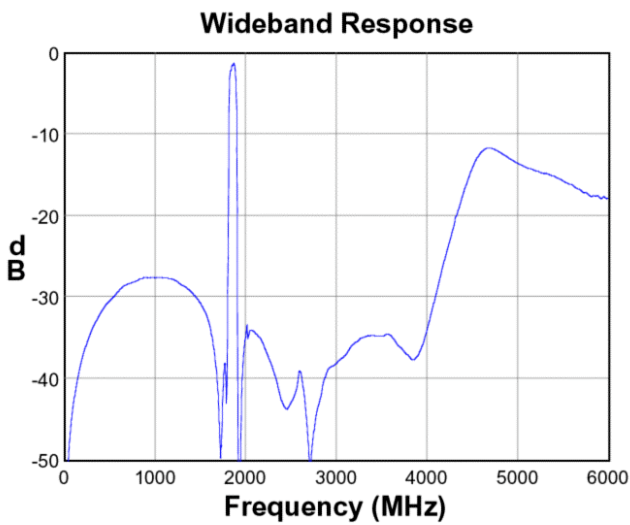
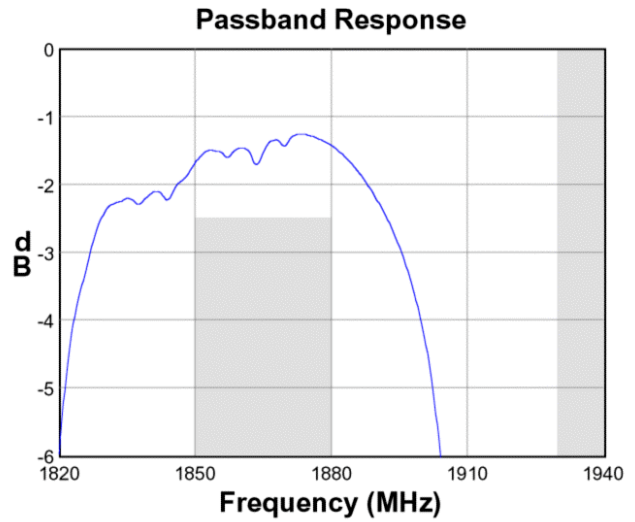
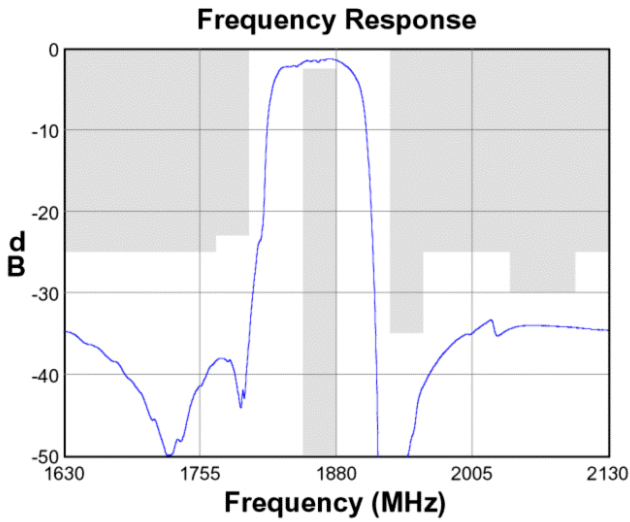

**Input Smith Chart**

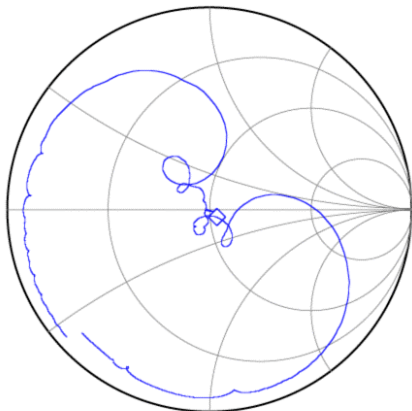

**Output Smith Chart**

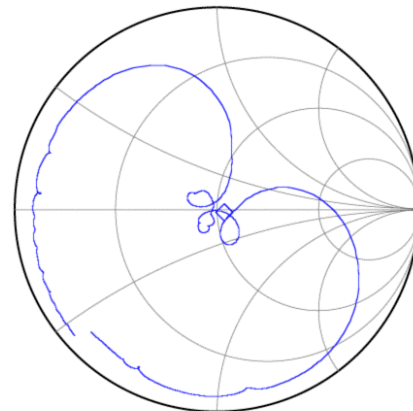

**Data Sheet**

**Band #2 Electrical Specifications <sup>(1)</sup>**

Operating Temperature Range: <sup>(2)</sup> -40 to +85 °C

Parameter <sup>(3)</sup>	Minimum	Typical	Maximum	Unit
<b>Center Frequency</b>	-	1895	-	MHz
<b>Maximum Insertion Loss</b> 1880 - 1910 MHz	-	1.9	2.5	dB
<b>Passband Ripple</b> 1880 - 1910 MHz	-	0.4	1.5	dB p-p
<b>Absolute Attenuation</b>				
DC - 1800 MHz	25	28	-	dB
1800 - 1830 MHz	24	35	-	dB
1960 - 1990 MHz	35	40	-	dB
1990 - 2040 MHz	25	34	-	dB
2040 - 2100 MHz	30	33	-	dB
2100 - 3000 MHz	25	39	-	dB
<b>Input/Output Return Loss</b> 1880 - 1910 MHz	10	20	-	dB
<b>Terminating Source Impedance: <sup>(4)</sup></b>	-	50	-	Ω
<b>Terminating Load Impedance: <sup>(4)</sup></b>	-	50	-	Ω
<b>Operating Temperature Range</b>	-40	+25	+85	°C

**Notes:**

1. All specifications are based on the test circuit shown below
2. In production, devices will be tested at room temperature to a guardbanded specification to ensure electrical compliance over temperature
3. Electrical margin has been built into the design to account for the variations due to temperature drift and manufacturing tolerances
4. This is the optimum impedance in order to achieve the performance shown

**Band #2 Test Circuit:**

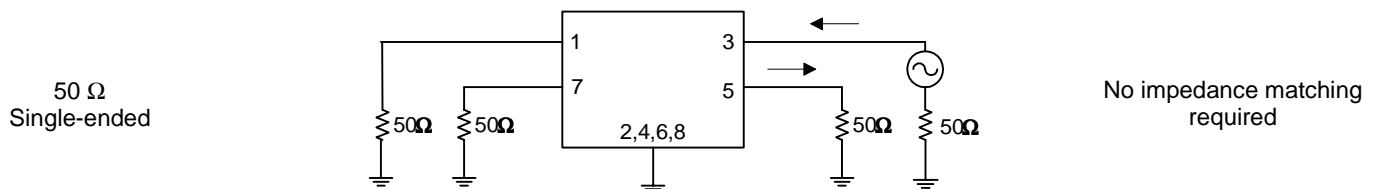

**Data Sheet**

**Band #2 Typical Performance (at +25°C)**

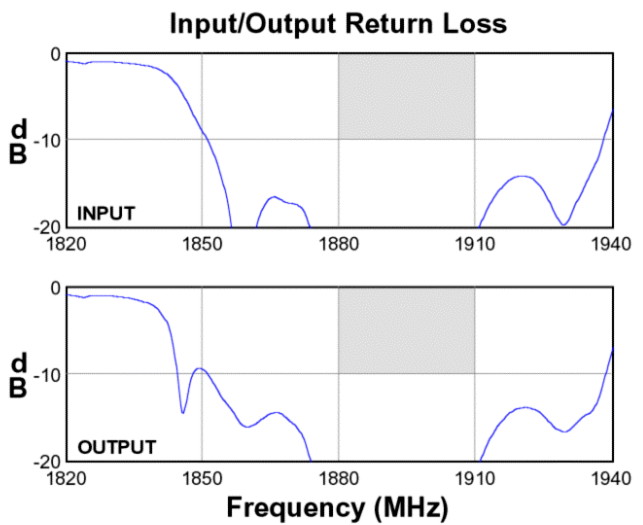
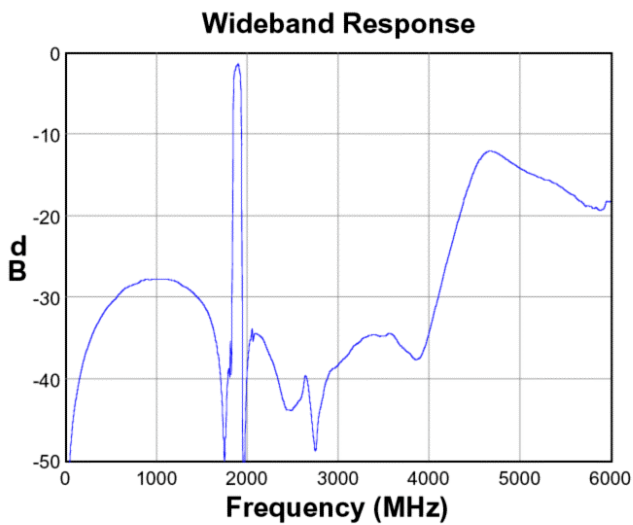
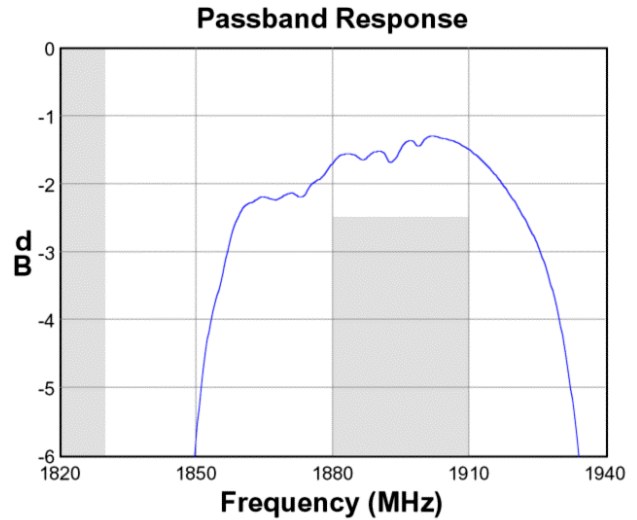
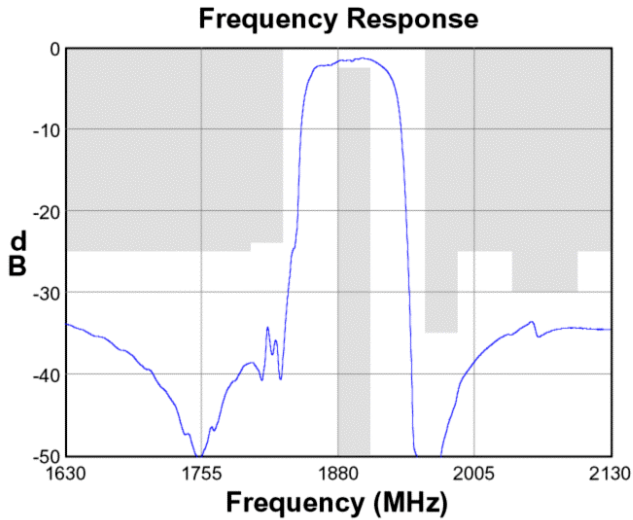

**Input Smith Chart**

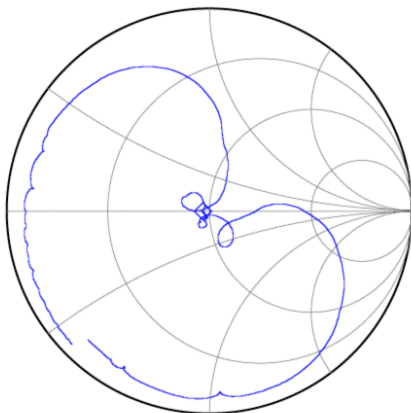

**Output Smith Chart**

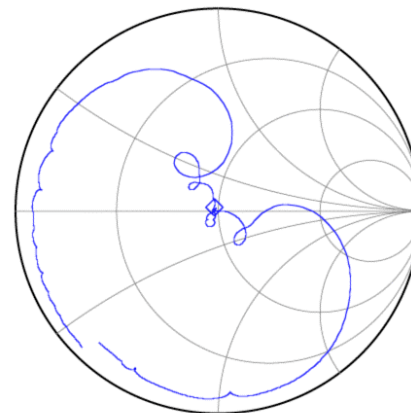

**Data Sheet**

**Matching Schematics**

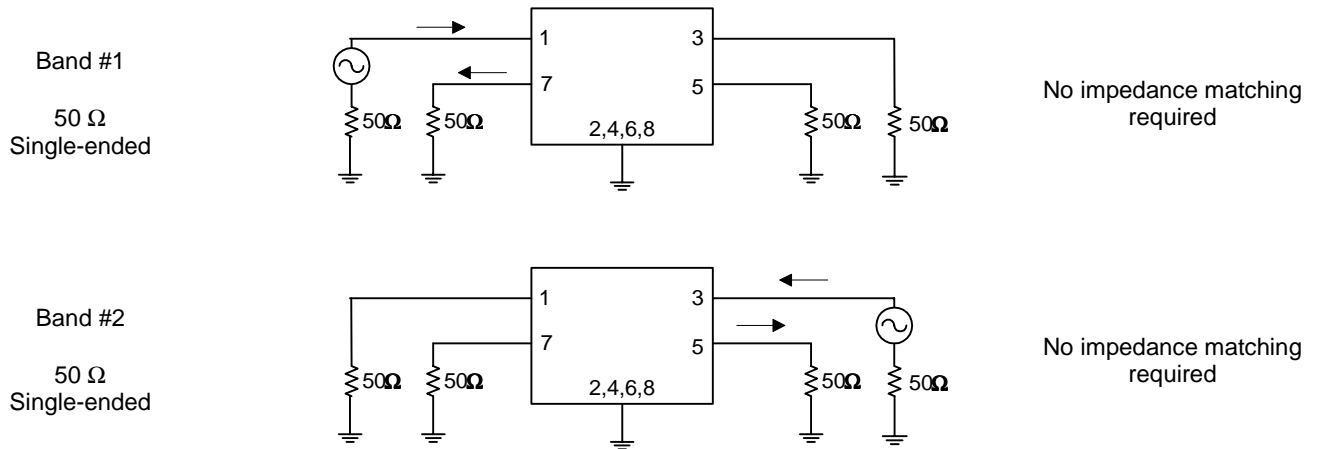

**Marking**

**PCB Footprint**

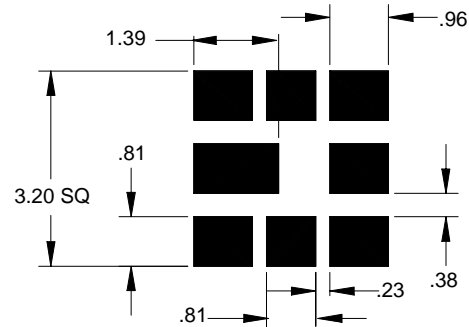
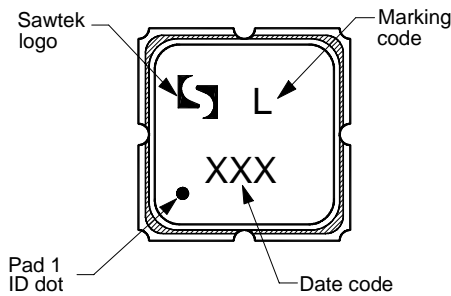

Date code is the day of the current year in 3-digit Julian format

This footprint represents a recommendation only  
Dimensions shown are nominal in millimeters

**Tape and Reel**

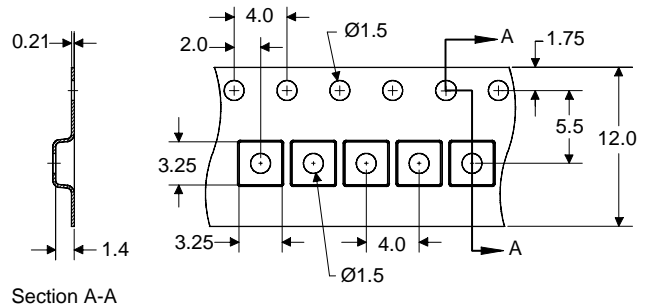
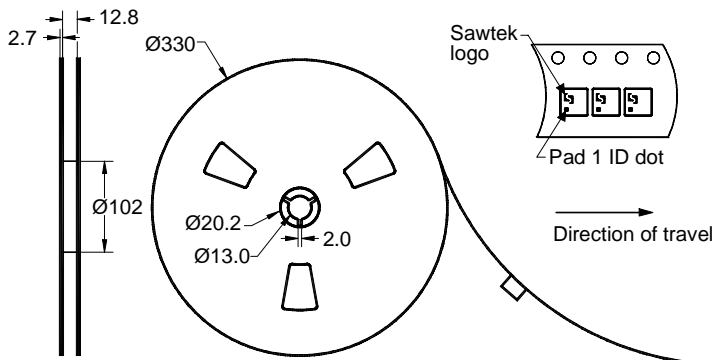

Dimensions shown are nominal in millimeters  
Packaging quantity: 5000 units/reel

**Data Sheet**

**Maximum Ratings**

Parameter	Symbol	Minimum	Maximum	Unit
Operating Temperature Range	T	-40	+85	°C
Storage Temperature Range	T <sub>stg</sub>	-40	+85	°C
RF Power	P <sub>in</sub>	-	+12	dBm

**Warnings**

- Electrostatic Sensitive Device (ESD) 
- Avoid ultrasonic exposure

**Links to Additional Technical Information**

[PCB Layout Tips](#)

[Qualification Flowchart](#)

[Soldering Profile](#)

[S-Parameters](#)

[Reel and Packaging Label](#)

[Other Technical Information](#)

**Contact Information**



PO Box 609501  
Orlando, FL 32860-9501  
USA

Phone: +1 (407) 886-8860  
Fax: +1 (407) 886-7061  
Email: [custservice@sawtek.com](mailto:custservice@sawtek.com)  
Web: [www.sawtek.com](http://www.sawtek.com)

Or contact one of our worldwide  
Network of [sales offices](#),  
[Representatives or distributors](#)