

SANKEN SWITCHING REGULATOR HYBRID IC

Type: STR-S6301

1. Scope:

The present specifications shall only apply to Sanken Switching Regulator Hybrid IC, type STR-S6301.

2. General

2.1 Category: Hybrid IC incorporated with a 3-layer Silicon Transistor,

2.2 Construction: Plastic Mold Package (Transfer Mold).

2.3 Application: Direct control, R.C.C. type Switching Regulator featuring Drive Circuit and the Over Current Protection. (using Photo Coupler as primary/secondary isolation element)

3. Equivalent Circuit

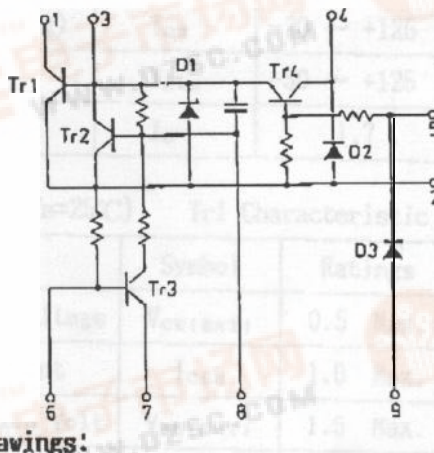

1. Collector
2. Emitter/Common (Power Tr.)
3. Base
4. Drive Control
5. Drive Control
6. Current Detector Base
7. Earth/Current Detector
8. Drive Tr2 Base
9. Photo Coupler (-)

4. Appearance and Outline Drawings:

4.1 Appearance

The body shall be clean and shall not bear any stain, rust or flaw.

4.2 Outline Drawings

Refer to Page 9.

4.3 Marking

The type number and lot number shall be legitimately be marked by laser printing.



SANKEN ELECTRIC COMPANY, LTD.

5. Maximum Ratings (Ta=25°C)

Description	Symbol	Rating	Unit	Conditions
Tr1 Collector-Emitter Voltage	V_{CEX}	500	V	※1
Pin# 4-2 Applying Voltage	V_{2-4}	12	V	
Pin# 2-5 Applying Voltage	V_{2-5}	12	V	
Pin# 5-9 Applying Voltage	V_{5-4}	30	V	
Pin# 7-6 Applying Voltage	V_{7-6}	5	V	
Tr1 Collector Current	$I_{C(Tr1)}$	10(Pulse:20)	A	※2
Tr4 Collector Current	$I_{C(Tr4)}$	500	mA	
D2 Forward Current	$I_{IN(D2)}$	500	mA	
D3 Forward Current	$I_{IN(D3)}$	100	mA	
Max. Power Dissipation	P_D	3.2	W	No fin ※3
		2.7		$T_{d1}=100^{\circ}C$ ※3
Tr1 Junction Temperature	T_J	+150	°C	
Frame Temperature (Operating)	T_{C2}	-20 ~ +125	°C	※4
Storage Temperature	T_{STG}	-30 ~ +125	°C	
Max. Output Current	I_d	1.7	A	$V_o = 115V$ ※5

8. Electrical Characteristic (Ta=25°C) Tr1 Characteristic

Description	Symbol	Rating	Unit	Conditions
Collector Saturation Voltage	$V_{CE(SAT)}$	0.5 Max.	V	$I_d = 6A, I_B = 1.2A$
Collector Cut-Off Current	I_{CEX}	1.0 Max.	mA	$V_{CE} = 500V, V_{BE} = -1.5V$
Base-Emitter Saturation Volt;	$V_{BE(SAT)}$	1.5 Max.	V	$I_d = 6A, I_B = 1.2A$
DC Current Gain	h_{FE}	15~40		$V_{CE} = 4V, I_C = 1A$
Thermal Resistance	θ_{J-C2}	0.7	°C/W	Junction~Internal Frame
Switching Time	t_d	10 Max.	μs	Measuring Circuit#1
	t_r	0.6 Max.		

※1 : Reference $V_{CEO} = 400V$ Min.

※2 : The Pulse applies to the condition of Reverse Bias ASO curve.

※3 : T_{C1} denotes the temperature of resin beneath the Power Transistor.

※4 : T_{C2} denotes the internal frame temperature. Recommended $T_{C2} = 100^{\circ}C$.

※5 : Measuring Circuit#1



7. Suggested method of attaching heatsink

- 1) Suggested Torque: 6 ~ 8 (kgf · cm)
- 2) Suggested Silicone Grease: C-746 SHIN-ETSU CHEMICALS
YG6260 TOSHIBA SILICONE
SC102 TORAY SILICONE

8. Other Conditions

- 1) This product is designed and built, for use under the normal environment.
It is susceptible to the radiation.
- 2) As this product is recognized as the Strategic Material which is under control of the Trade & Export Law, an export licence granted by the government is required for exportation.



SANKEN ELECTRIC COMPANY, LTD.

Measuring circuit, (Switching time)

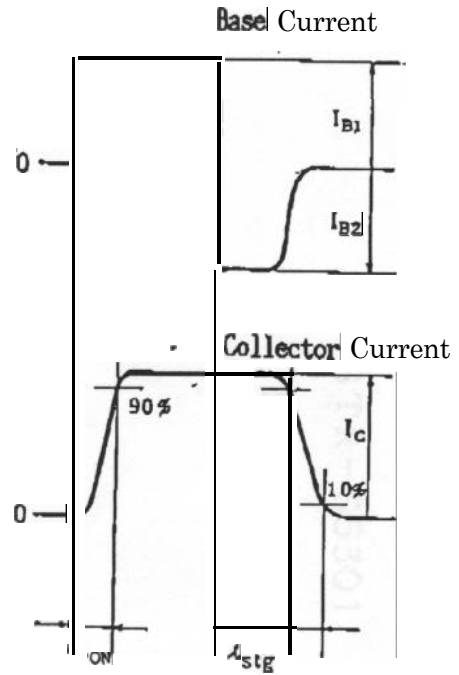
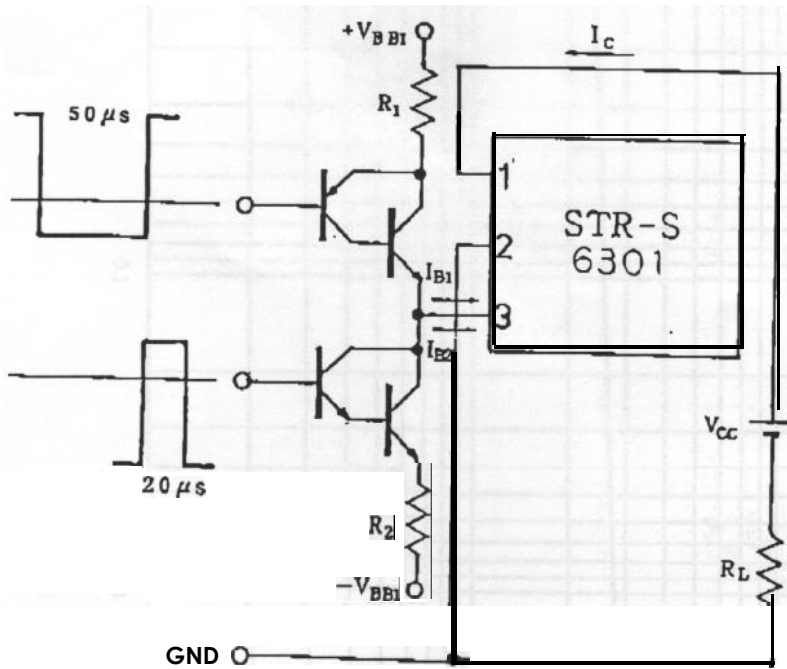

$$I_d = 3.5 \text{ A} , R_L = 28.6 \Omega$$

$$I_{B1} = 800 \text{ mA} , I_{B2} = 800 \text{ mA}$$



SANKEN ELECTRIC COMPANY, LTD.

STR-S6301

$I_C - h_{FE}$ Characteristic

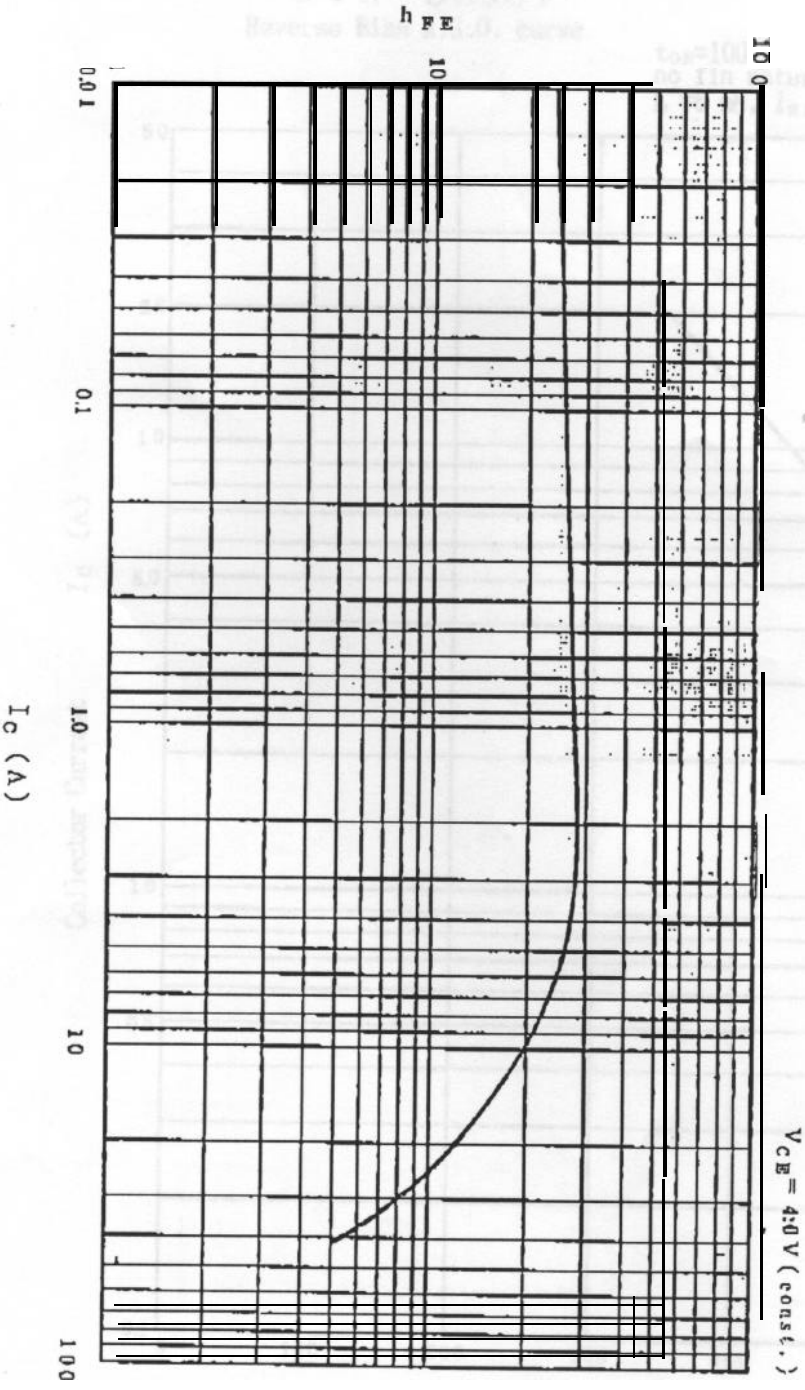

SANKEN ELECTRIC COMPANY, LTD.

STR-S6301
Reverse Bias A.S.O. curve

$t_{ON}=100 \mu\text{sec}$ (duty 1:1% or less)
no fin natural cooling ($T_a=25^\circ\text{C}$)
 $L \square 6 \text{ mH}, I_{B1}=3.5\text{A}, I_{B2}=0.5\text{A}$

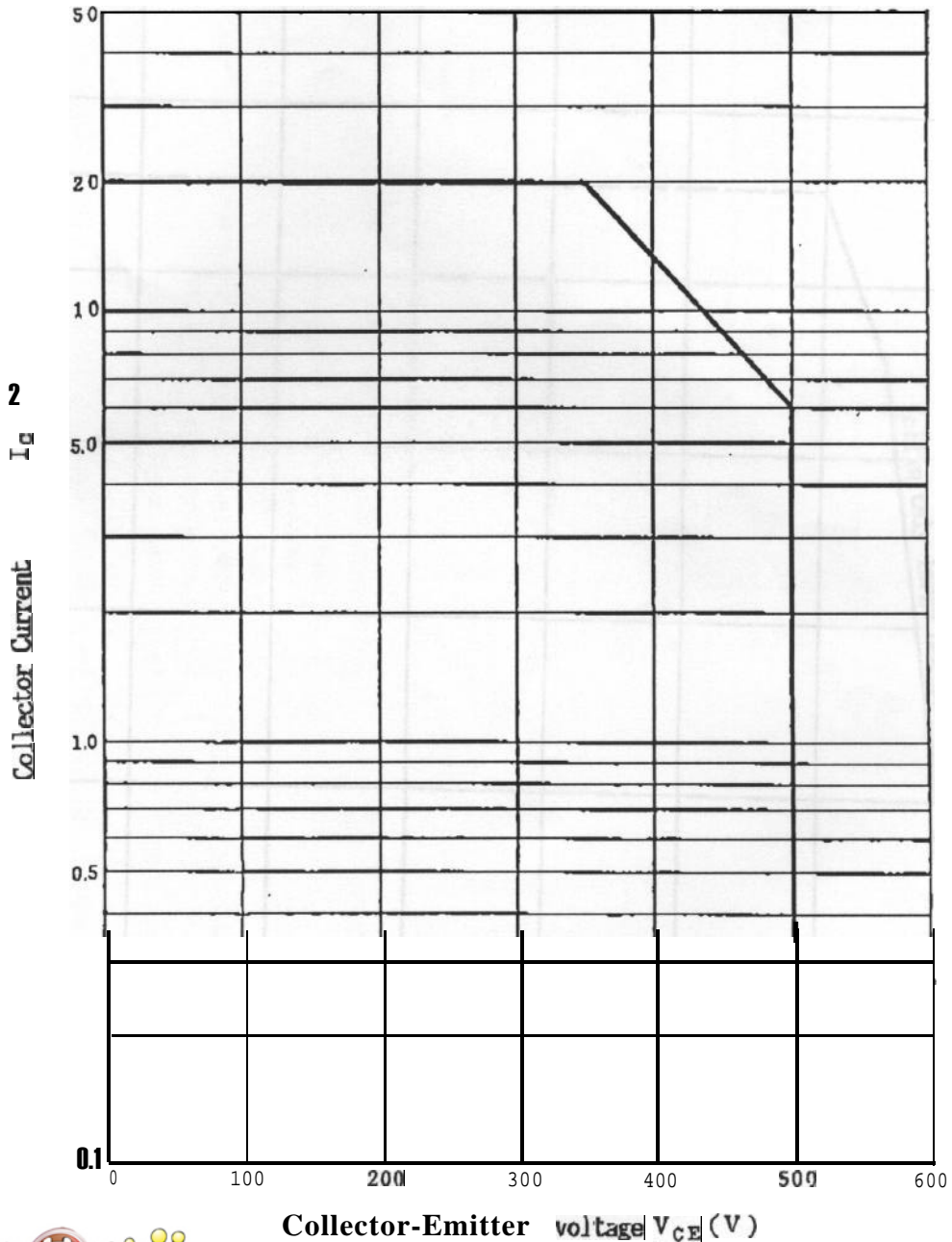

SANKEN ELECTRIC COMPANY, LTD.

STR-S6000 series derating curve

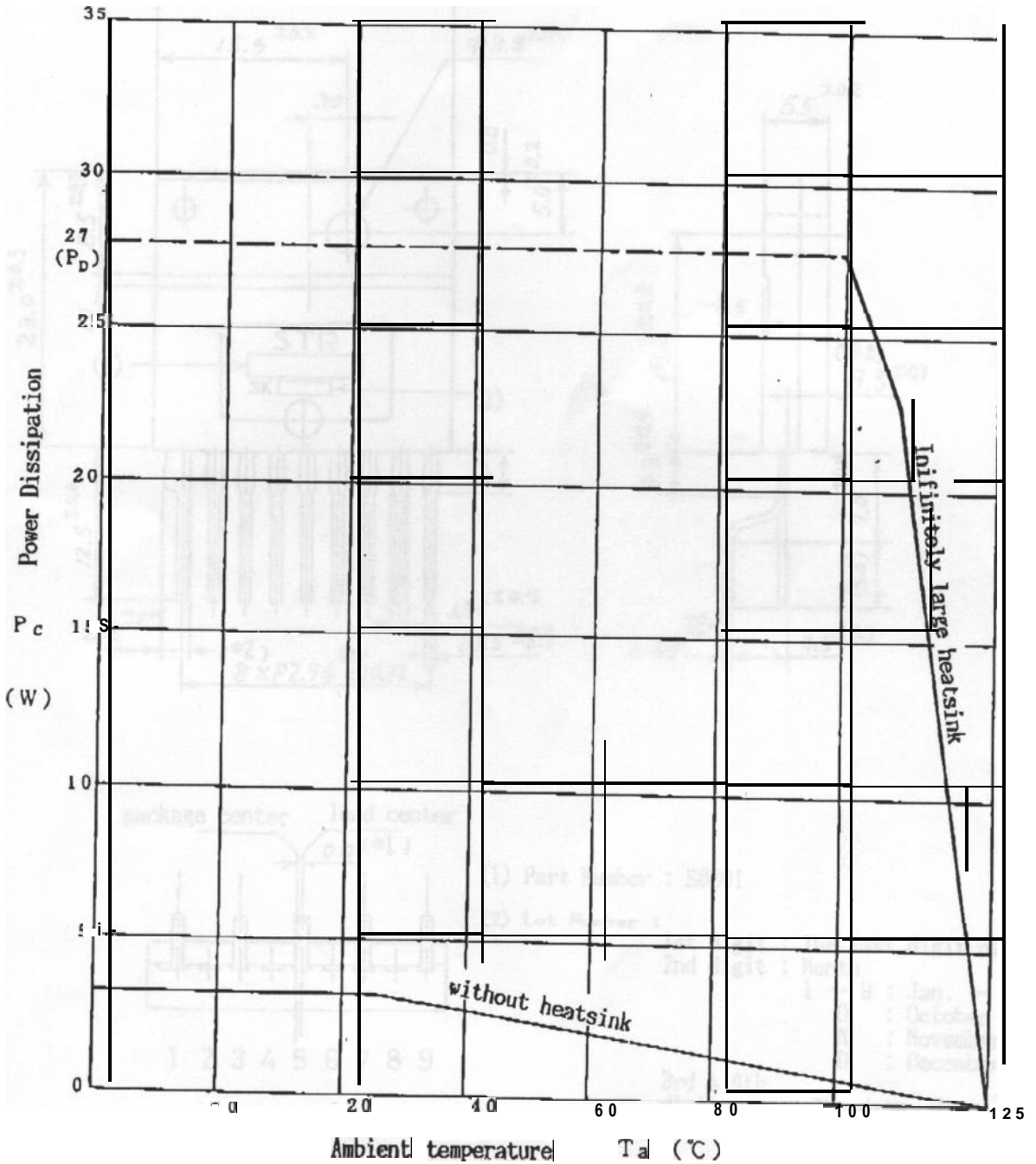

SANKEN ELECTRIC COMPANY. LTD.

unit 1mm

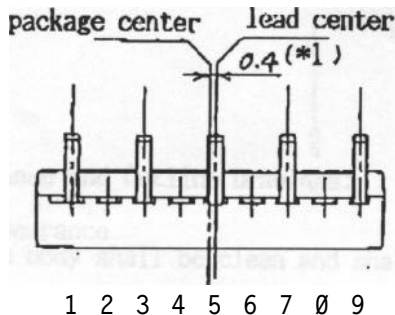
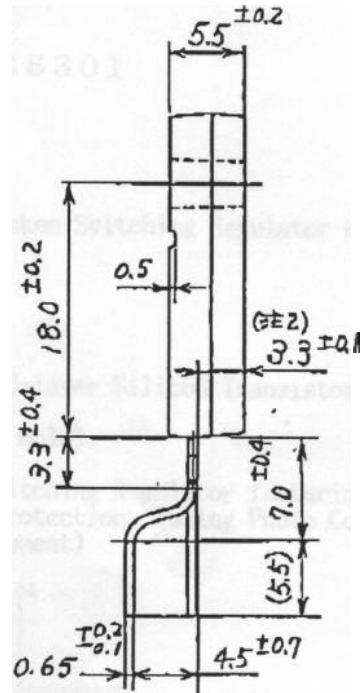
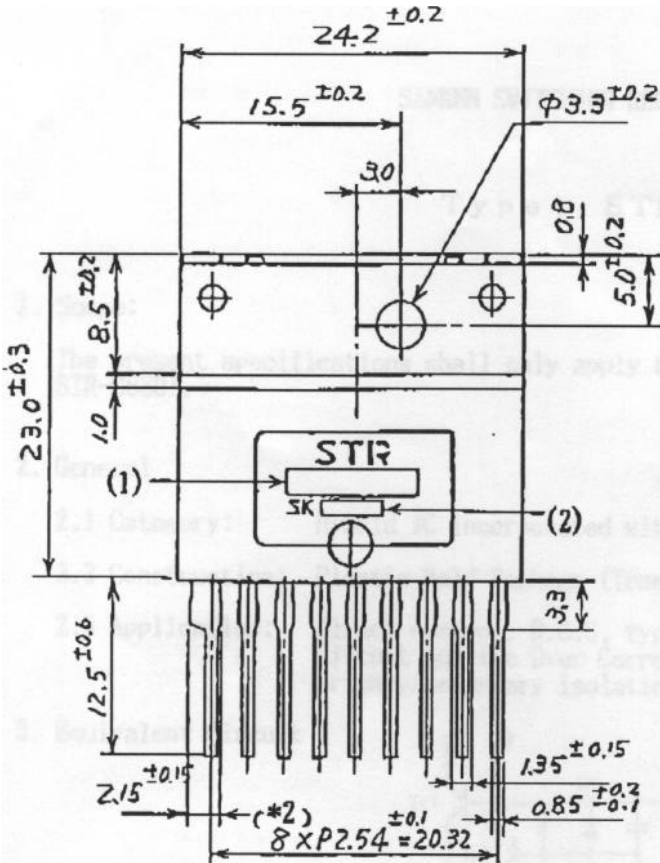

(1) Part Number : S6301

(2) Lot Number :

1st digit : The last digit of AD year
2nd digit : Month

1 ~ 9 : Jan. ~ Sept.

0 : October

N : November

D : December

3rd & 4th digits

The date 01 ~ 31

*1: The lead center is offset by 0.4mm from the center of the package.

*2: The lead center is offset by 0.4mm from the center of the package.