

TOSHIBA

Toshiba TLxE1008A SMT LEDs

Features

1.6 x 0.8 x 0.6 mm (L x W x H)
 Incorporates opaque diffusing resin. Good Light diffusion—ideal for backlighting
 InGaAIP Technology
 Reflow soldering is possible
 Standard embossed taping 4 mm pitch : T04 (4000 pcs/reel)

Applications

Backlighting for battery-powered equipment
 Low-power electronic equipment
 Pilot light for compact equipment

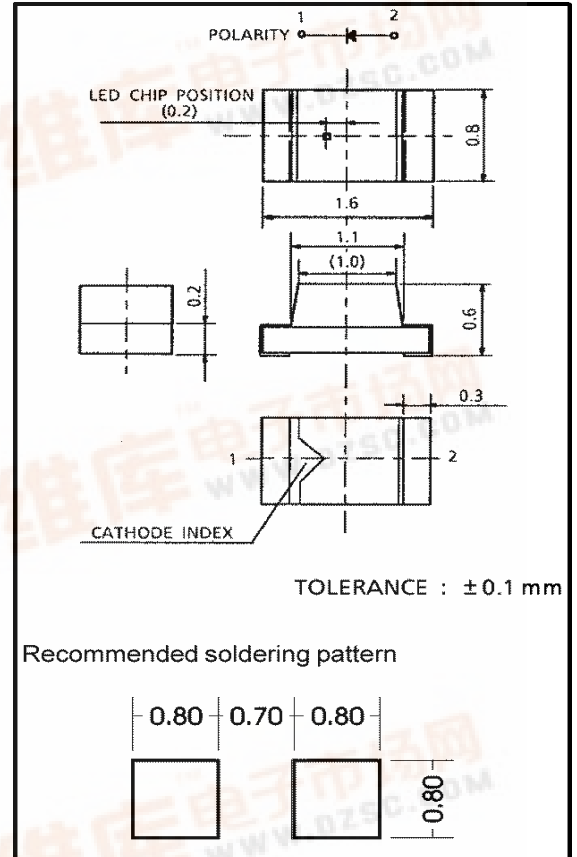

Series Line-Up

Part Number	Color	Material
TLGE1008A	Ultra Bright Yellow Green	InGaAIP
TLOE1008A	Ultra Bright Orange	InGaAIP
TLPGE1008A	Ultra Pure Green	InGaAIP
TLRE1008A	Ultra Bright Red	InGaAIP
TLSE1008A	Ultra Bright High Efficiency Red	InGaAIP
TLYE1008A	Ultra Bright Yellow	InGaAIP

Maximum Ratings (Ta=25°C)

Part Number	Forward Current I _F	Reverse Voltage V _R	Power Dissipation P _D	Operating Temperature T _{opr}	Storage Temperature T _{stg}
TLGE1008A	25	4	60.00	-25 ~ +85	-30 ~ +85
TLOE1008A	25	4	60.00	-25 ~ +85	-30 ~ +85
TLPGE1008A	25	4	60.00	-25 ~ +85	-30 ~ +85
TLRE1008A	25	4	60.00	-25 ~ +85	-30 ~ +85
TLSE1008A	25	4	60.00	-25 ~ +85	-30 ~ +85
TLYE1008A	25	4	60.00	-25 ~ +85	-30 ~ +85
Unit	mA	V	mW	°C	°C

Electrical and Optical Characteristics (Ta=25°C)

Part Number	PWL nm λ_P	Material	View Angle $2\theta_{1/2}$	Luminous Intensity I_v				Forward Voltage V_F				Rev Current I_R	
				min.	typ.	max.	IF@	min.	typ.	max.	IF@	max.	VR@
TLGE1008A	574	InGaAlP	110°	27.20	70.00	–	20mA	–	2.00	2.40	20mA	50	4V
TLOE1008A	612	InGaAlP	110°	47.60	150.00	–	20mA	–	2.00	2.40	20mA	50	4V
TLPGE1008A	562	InGaAlP	110°	4.76	18.00	–	20mA	–	2.10	2.40	20mA	50	4V
TLRE1008A	644	InGaAlP	110°	27.20	70.00	–	20mA	–	1.90	2.40	20mA	50	4V
TLSE1008A	623	InGaAlP	110°	47.60	135.00	–	20mA	–	1.90	2.40	20mA	50	4V
TLYE1008A	590	InGaAlP	110°	27.20	105.00	–	20mA	–	2.00	2.40	20mA	50	4V
–	nm	–	deg	mcd				–	V		–	μA	–

NOTICE:

- TOSHIBA is continually working to improve the quality and reliability of its products. Nevertheless, semiconductor devices in general can malfunction or fail due to their inherent electrical sensitivity and vulnerability to physical stress. It is the responsibility of the buyer, when utilizing TOSHIBA products, to comply with the standards of safety in making a safe design for the entire system, and to avoid situations in which a malfunction or failure of such TOSHIBA products could cause loss of human life, bodily injury or damage to property.
- In developing your designs, please ensure that TOSHIBA products are used within specified operating ranges as set forth in the most recent TOSHIBA products specifications. Also, please keep in mind the precautions and conditions set forth in the "Handling Guide for Semiconductor Devices," or "TOSHIBA Semiconductor Reliability Handbook" etc..
- The TOSHIBA products listed in this document are intended for usage in general electronics applications (computer, personal equipment, office equipment, measuring equipment, industrial robotics, domestic appliances, etc.). These TOSHIBA products are neither intended nor warranted for usage in equipment that requires extraordinarily high quality and/or reliability or a malfunction or failure of which may cause loss of human life or bodily injury ("Unintended Usage"). Unintended Usage include atomic energy control instruments, airplane or spaceship instruments, transportation instruments, traffic signal instruments, combustion control instruments, medical instruments, all types of safety devices, etc.. Unintended Usage of TOSHIBA products listed in this document shall be made at the customer's own risk.
- Gallium arsenide (GaAs) is a substance used in the products described in this document. GaAs dust and fumes are toxic. Do not break, cut or pulverize the product, or use chemicals to dissolve them. When disposing of the products, follow the appropriate regulations. Do not dispose of the products with other industrial waste or with domestic garbage.
- The information contained herein is presented only as a guide for the applications of our products. No responsibility is assumed by TOSHIBA CORPORATION for any infringements of intellectual property or other rights of the third parties which may result from its use. No license is granted by implication or otherwise under any intellectual property or other rights of TOSHIBA CORPORATION or others.
- The information contained herein is subject to change without notice.



TLGE1008A Graphs

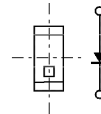
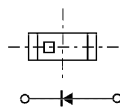
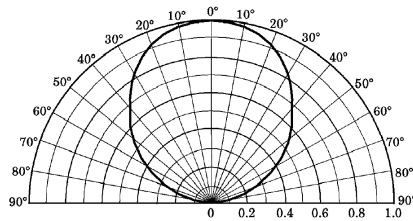
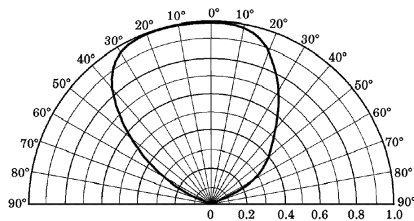
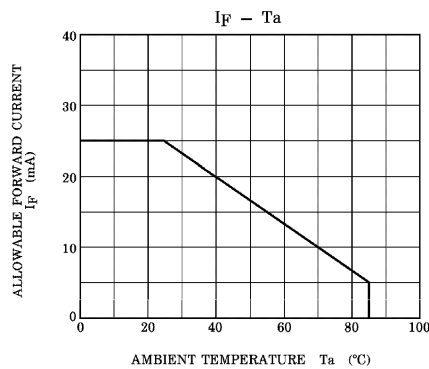
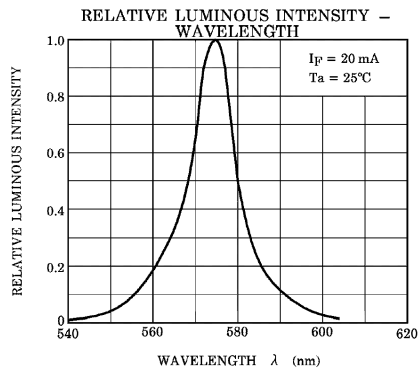
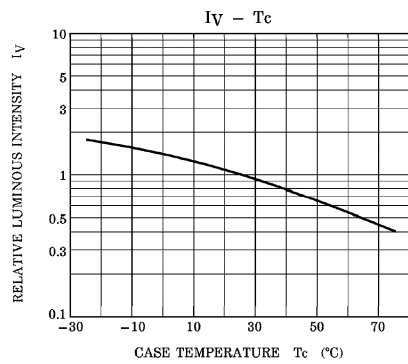
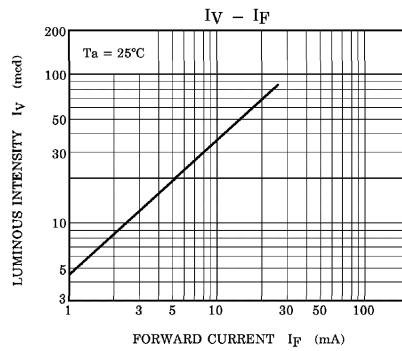
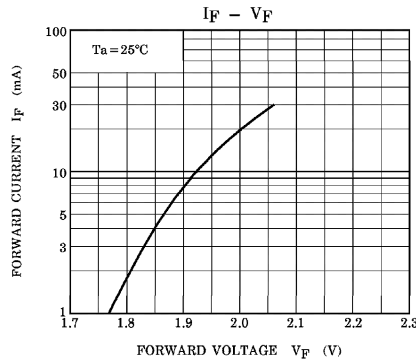

TLOE1008A Graphs

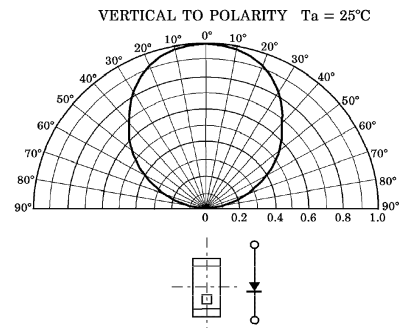
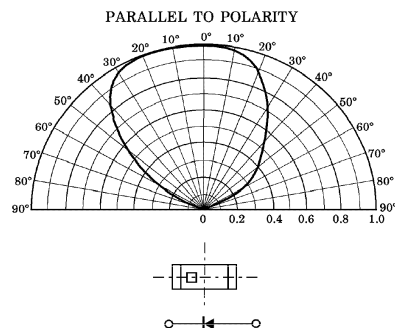
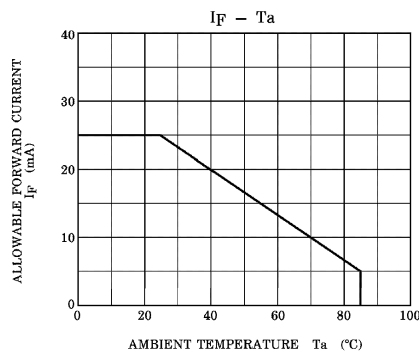
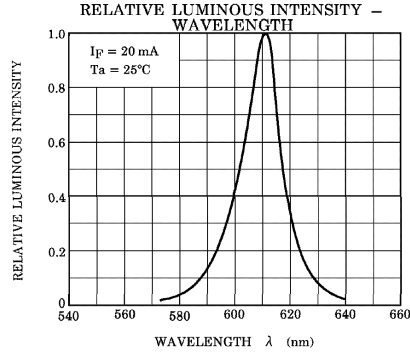
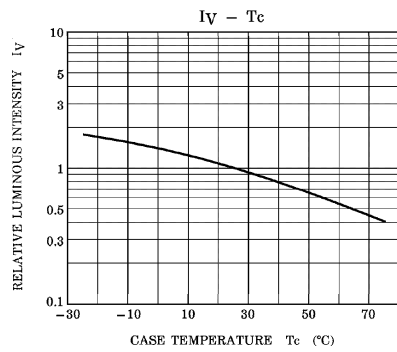
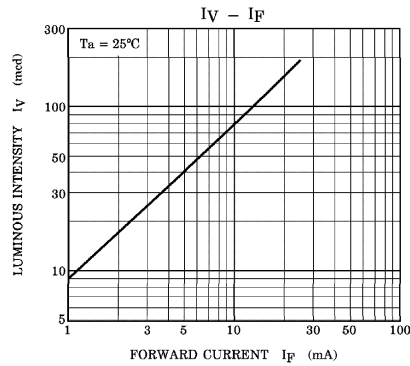
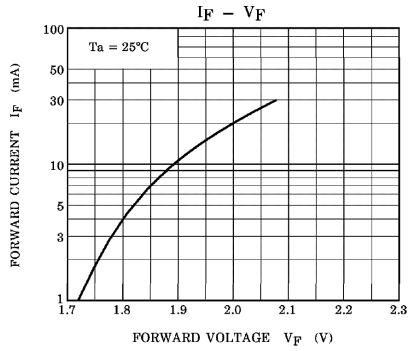

TLPGE1008A Graphs

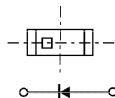
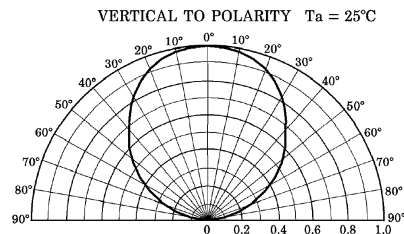
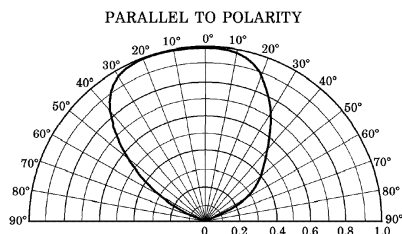
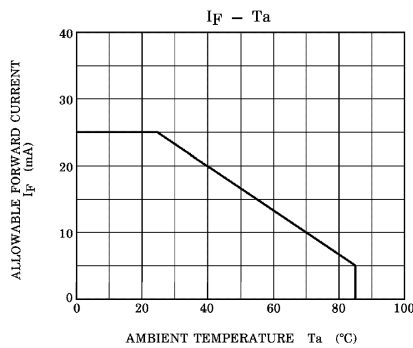
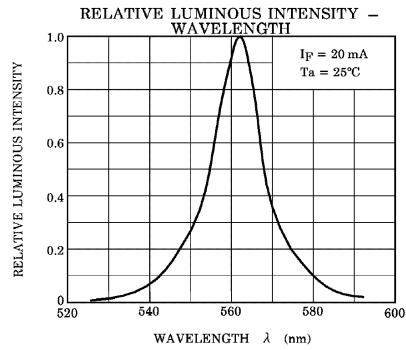
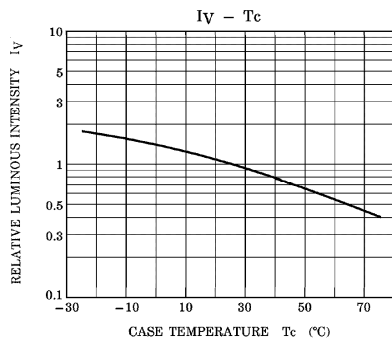
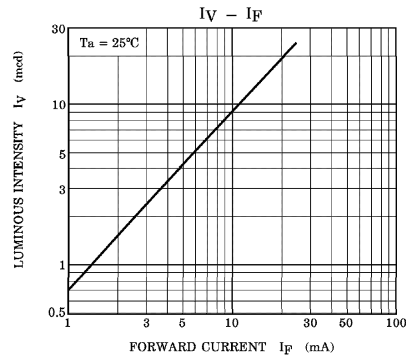
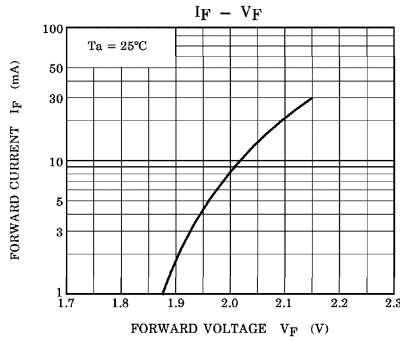

TLRE1008A Graphs

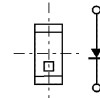
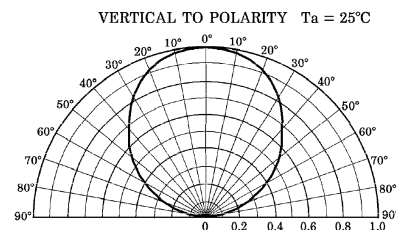
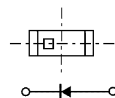
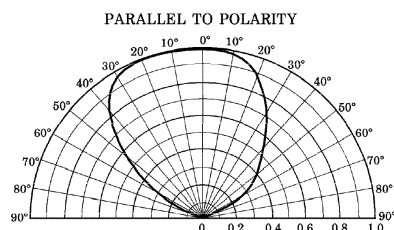
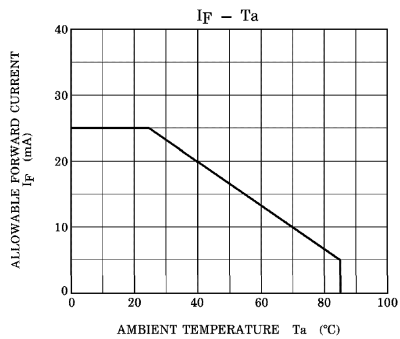
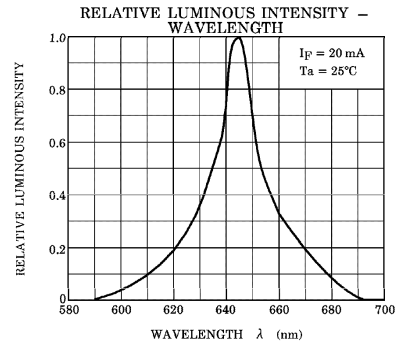
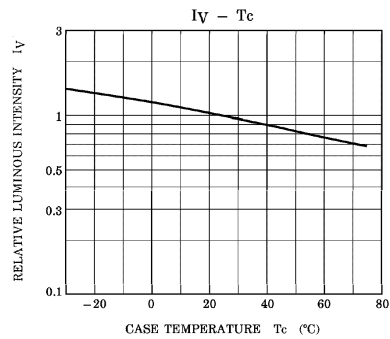
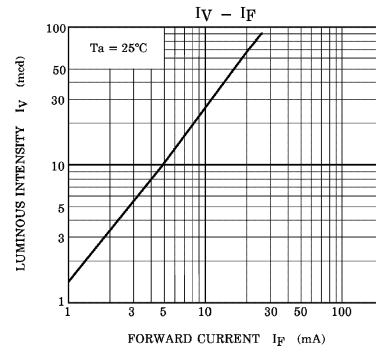
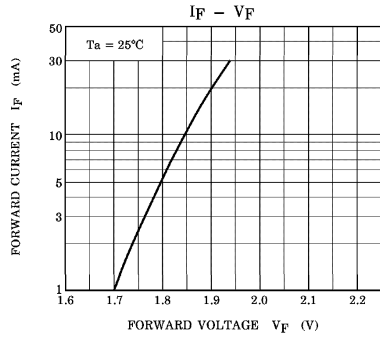

TLSE1008A Graphs

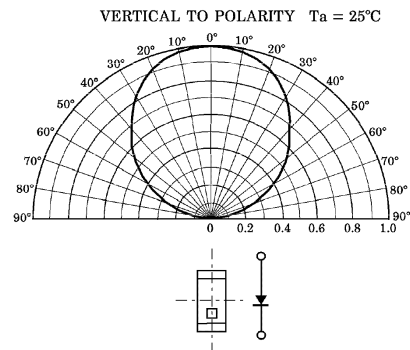
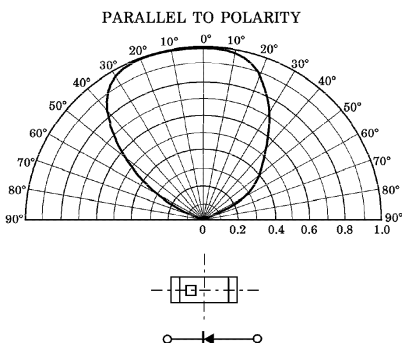
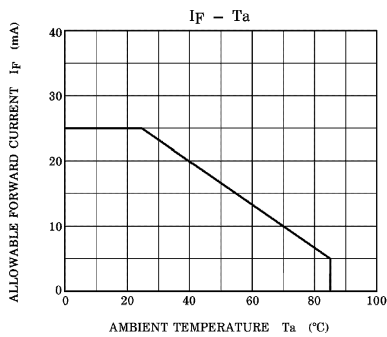
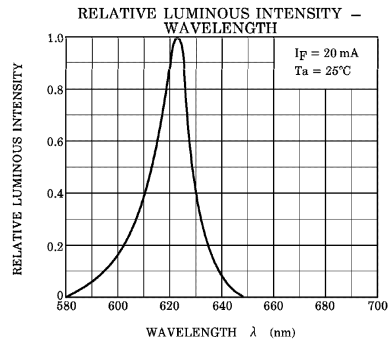
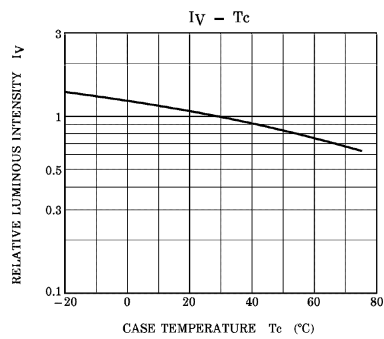
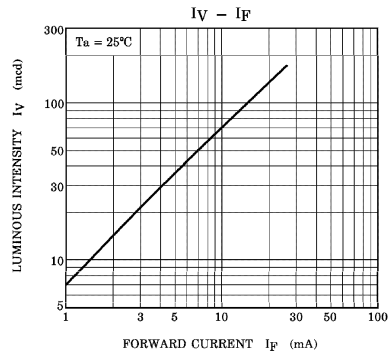
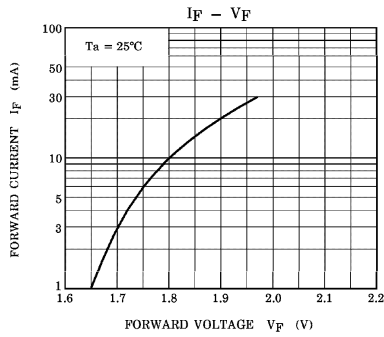

TLYE1008A Graphs

