

TOSHIBA

TL(RE,SE,OE,YE,PYE,GE,FGE,PGE)1002A(T02)

TOSHIBA LED LAMP

**TLRE1002A(T02), TLSE1002A(T02), TLOE1002A(T02), TLYE1002A(T02)
TLPYE1002A(T02), TLGE1002A(T02), TLFGE1002A(T02), TLPGE1002A(T02)**
PANEL CIRCUIT INDICATOR

Unit in mm

- 2.0 × 1.25 × 1.1 mm (L × W × H)
TL□E1002A (T02) Series
- InGaAlP LED
- It can be manufactured high-luminosity of equipment or reduce of electric power consumption by change in the high-luminosity LED from general-luminosity one.
- Colors : Red, Orange, Yellow, Pure Yellow, Green, Pure Green
- Can be mounted using surface mounter.
- Reflow soldering is possible.
- Standard embossed taping
4 mm pitch : T02 (3000 pcs / reel)
- Applications : As backlighting source for battery-powered equipment
As pilot light for compact equipment
In low-power electronic equipment, etc.

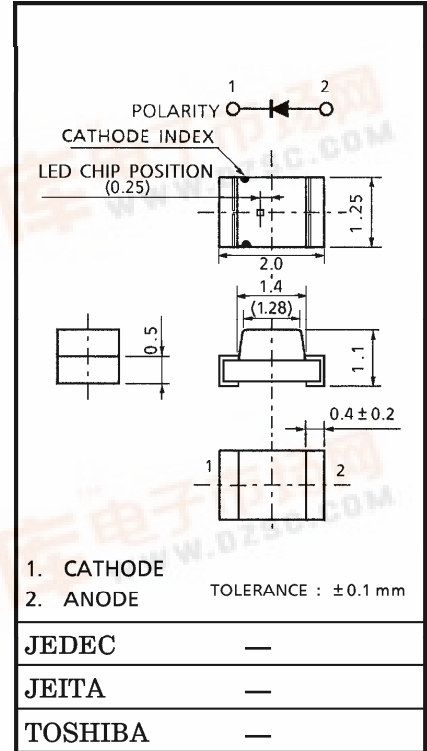

Weight : 0.002g

LINE-UP

PRODUCT NAME	COLOR	MATERIAL
TLRE1002A	Red	InGaAlP
TLSE1002A	Red	InGaAlP
TLOE1002A	Orange	InGaAlP
TLYE1002A	Yellow	InGaAlP
TLPYE1002A	Pure Yellow	InGaAlP
TLGE1002A	Green	InGaAlP
TLFGE1002A	Green	InGaAlP
TLPGE1002A	Pure Green	InGaAlP

MAXIMUM RATINGS (Ta = 25°C)

PRODUCT NAME	FORWARD CURRENT (DC) I_F (mA)	REVERSE VOLTAGE V_R (V)	POWER DISSIPATION P_D (mW)	OPERATION TEMPERATURE T_{opr} (°C)	STORAGE TEMPERATURE T_{stg} (°C)
TLRE1002A	25	4	60	-40~85	-40~100
TLSE1002A					
TLOE1002A					
TLYE1002A					
TLPYE1002A					
TLGE1002A					
TLFGE1002A					
TLPGE1002A					

ELECTRICAL CHARACTERISTICS (Ta = 25°C)

PRODUCT NAME	FORWARD VOLTAGE V_F			I_F	REVERSE CURRENT I_R	
	MIN	TYP.	MAX		MAX	V_R
TLRE1002A	—	1.9	2.4	20	50	4
TLSE1002A	—	1.9	2.4			
TLOE1002A	—	2.0	2.4			
TLYE1002A	—	2.0	2.4			
TLPYE1002A	—	2.0	2.4			
TLGE1002A	—	2.0	2.4			
TLFGE1002A	—	2.0	2.4			
TLPGE1002A	—	2.1	2.4			
UNIT	V			mA	μ A	V

OPTICAL CHARACTERISTICS (Ta = 25°C)

PRODUCT NAME	LUMINOUS INTENSITY I_V				EMISSION SPECTRUM							
	MIN	TYP.	MAX	I_F	Peak Emission Wavelength λ_p				Dominant Wavelength λ_d			I_F
					MIN	TYP.	MAX	TYP.	MIN	TYP.	MAX	
TLRE1002A	27.2	70	—	20	—	644	—	18	—	630	—	20
TLSE1002A	47.6	140	—		—	623	—	17	—	613	—	
TLOE1002A	47.6	180	—		—	612	—	15	—	605	—	
TLYE1002A	27.2	105	—		—	590	—	13	—	587	—	
TLPYE1002A	27.2	70	—		—	583	—	13	—	580	—	
TLGE1002A	27.2	70	—		—	574	—	11	—	571	—	
TLFGE1002A	15.3	40	—		—	568	—	11	—	565	—	
TLPGE1002A	4.76	18	—		—	562	—	11	—	558	—	
UNIT	mcd			mA	nm			nm	nm			mA

(Note) : This visible LED lamp also emits some IR light.
 If a photodetector is located near the LED lamp, please ensure that it will not be affected by this IR light.



TLRE1002A

$I_F - V_F$

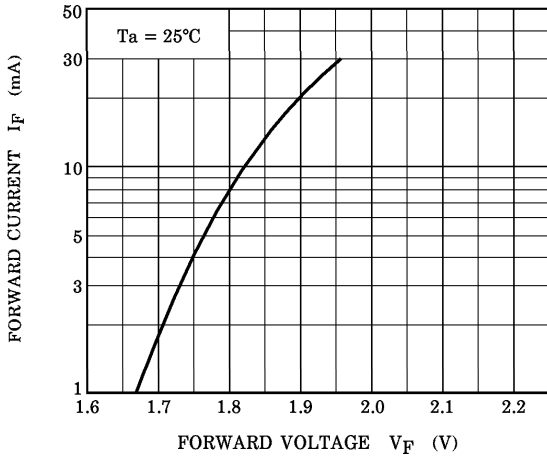

$I_V - I_F$

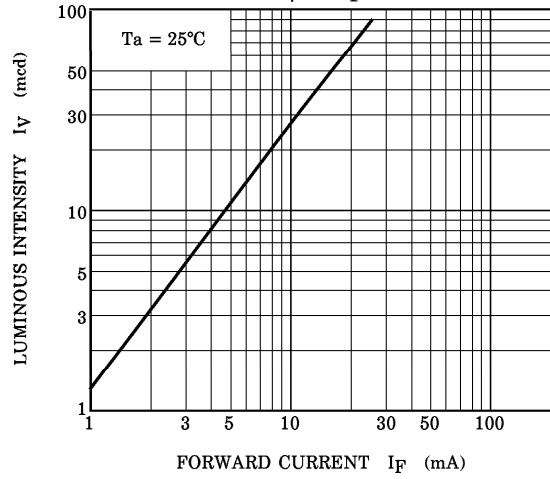

$I_V - T_c$

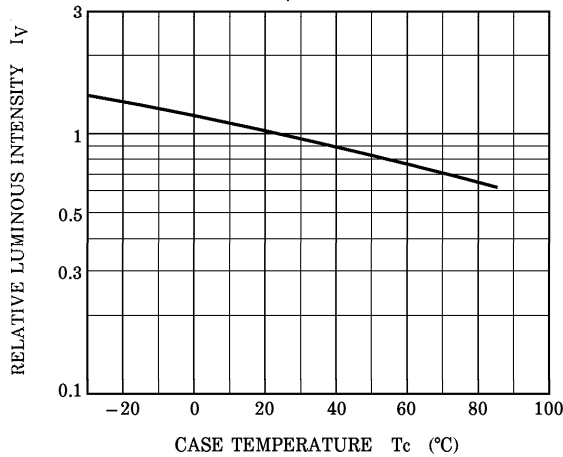

RELATIVE LUMINOUS INTENSITY - WAVELENGTH

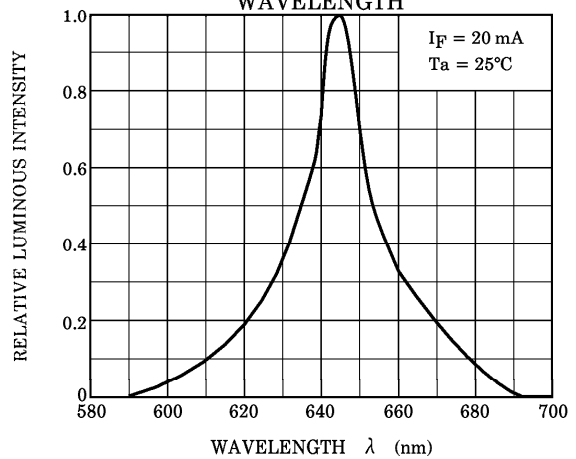

$I_F - T_a$

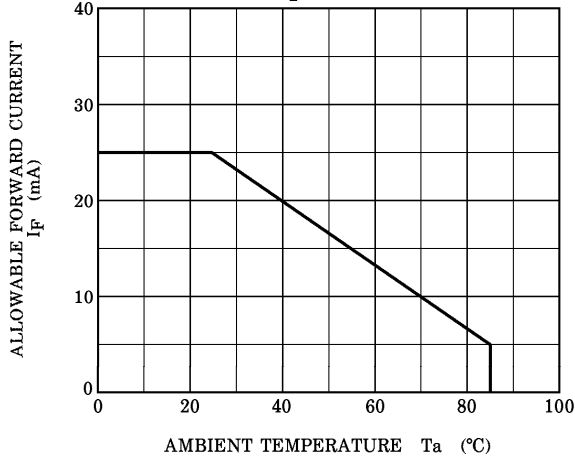

TLSE1002A

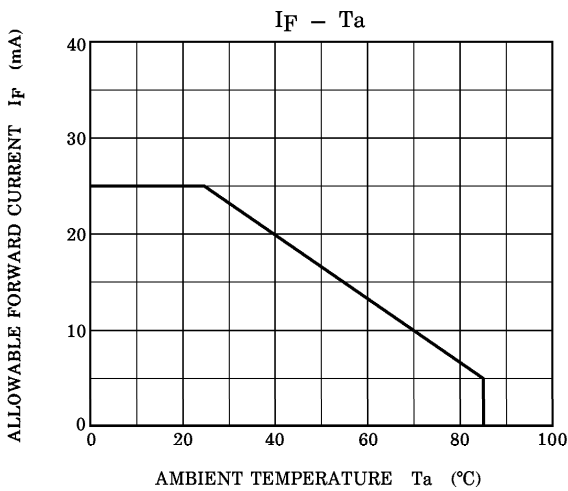
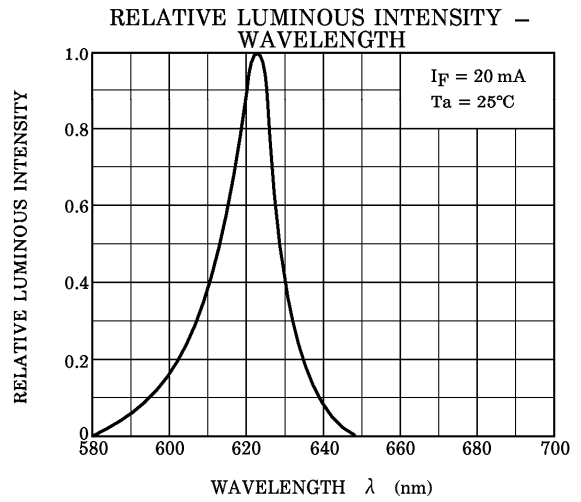
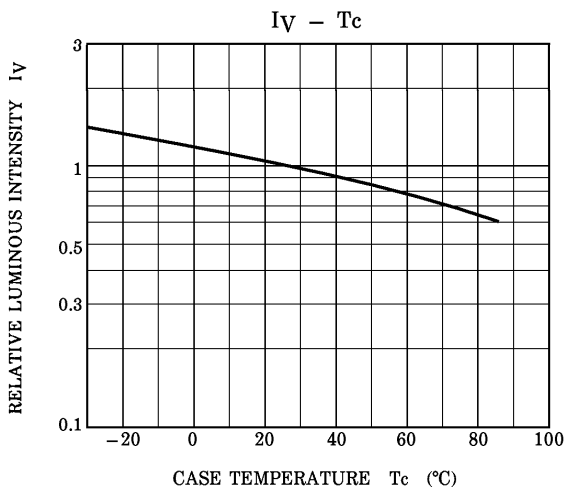
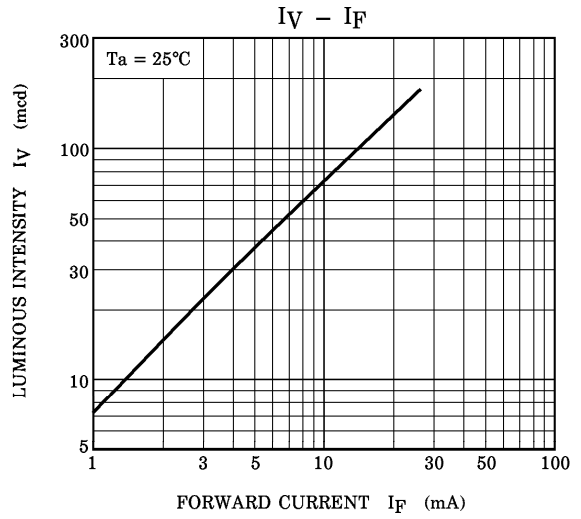
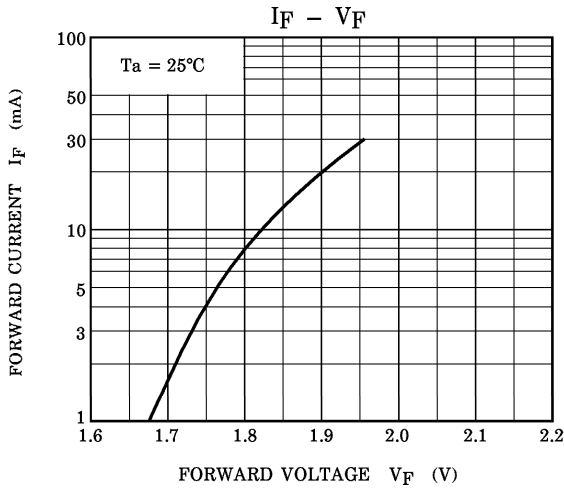

TLOE1002A

$I_F - V_F$

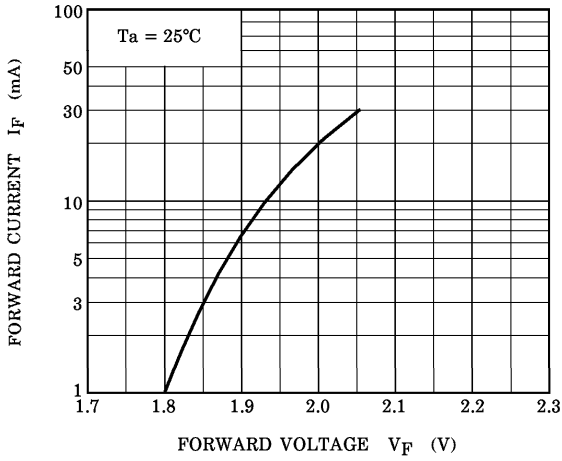

$I_V - I_F$

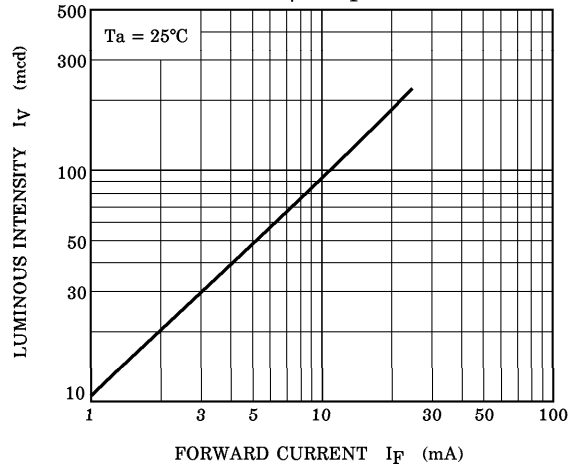

$I_V - T_c$

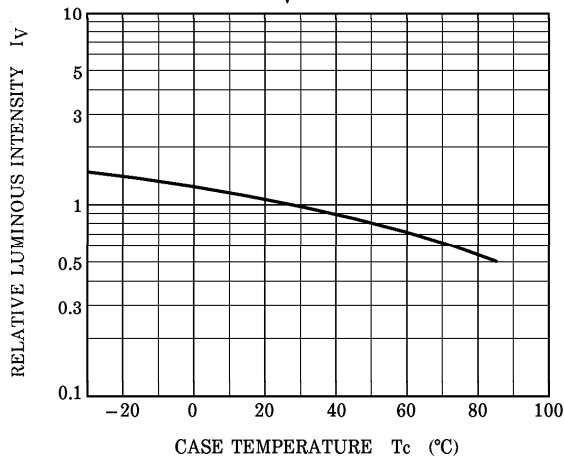

RELATIVE LUMINOUS INTENSITY - WAVELENGTH

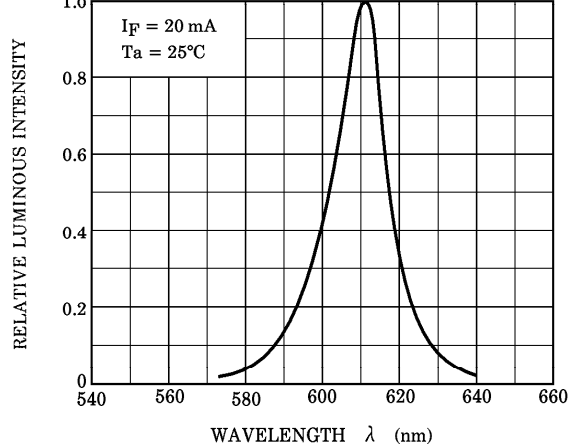

$I_F - T_a$

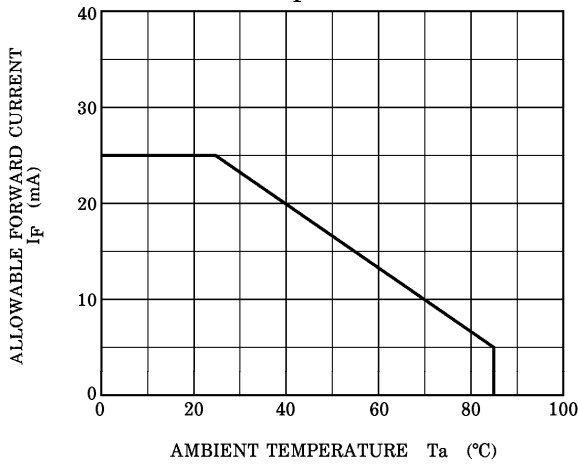

TLYE1002A

$I_F - V_F$

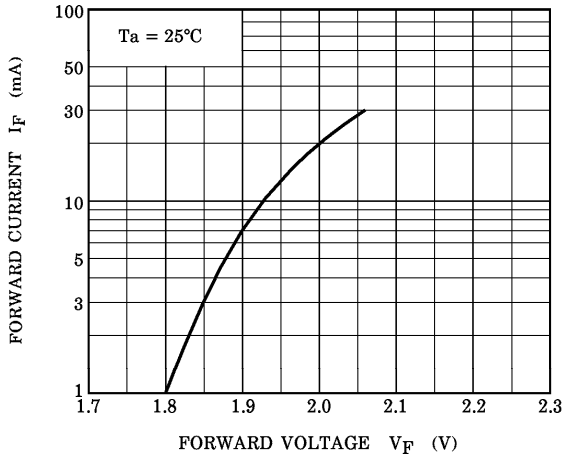

$I_V - I_F$

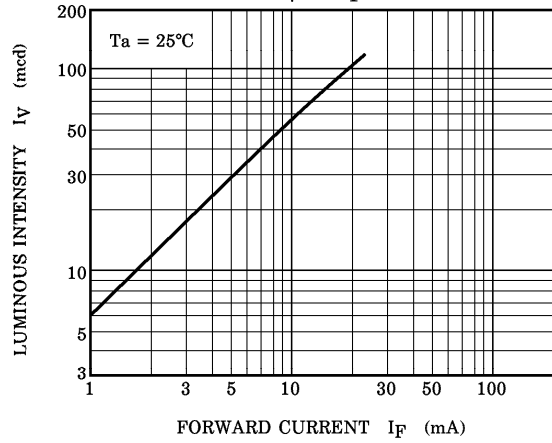

$I_V - T_c$

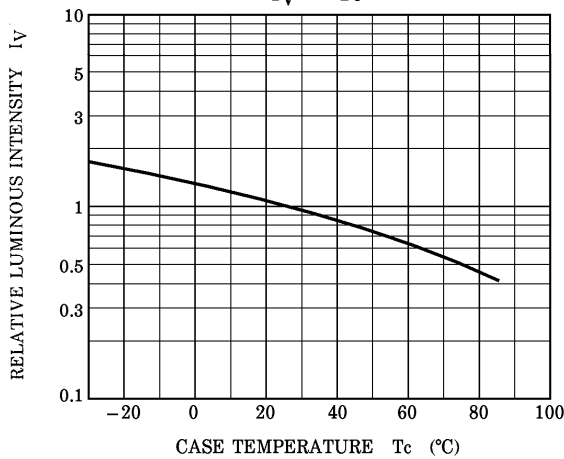

RELATIVE LUMINOUS INTENSITY - WAVELENGTH

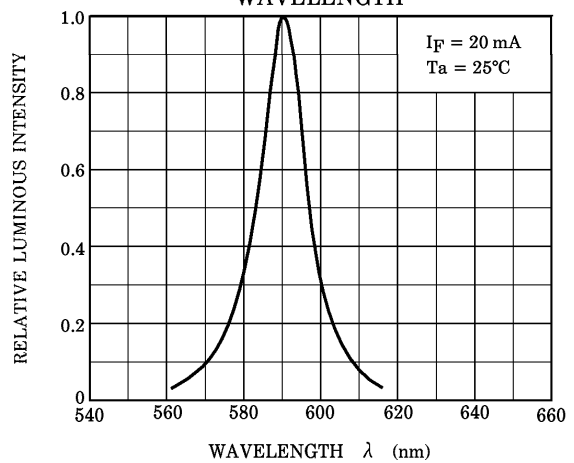

$I_F - T_a$

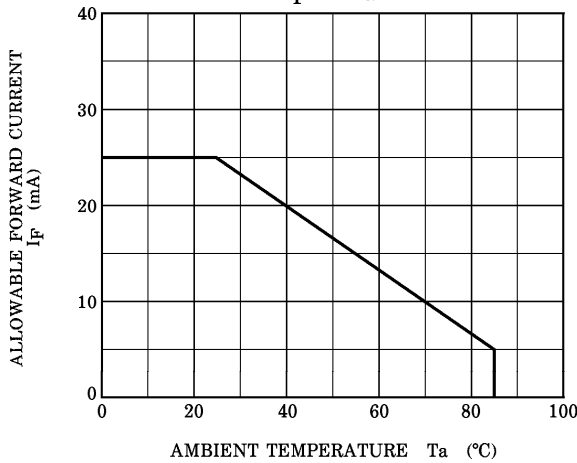

TLPYE1002A

$I_F - V_F$

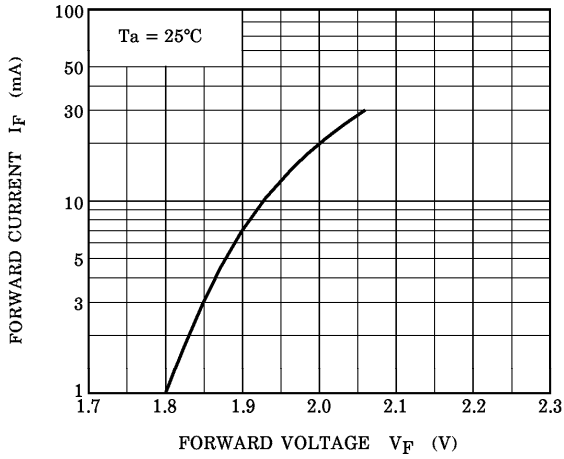

$I_V - I_F$

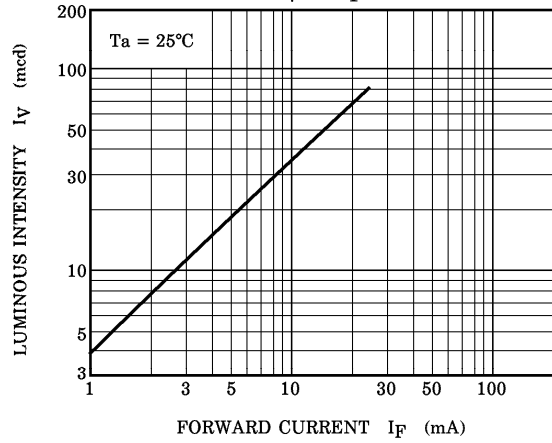

$I_V - T_c$

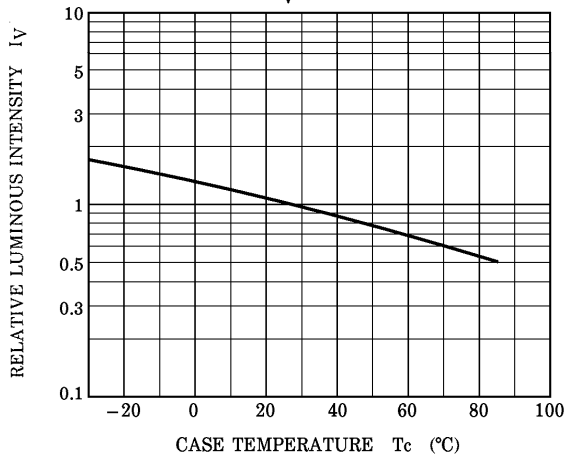

RELATIVE LUMINOUS INTENSITY - WAVELENGTH

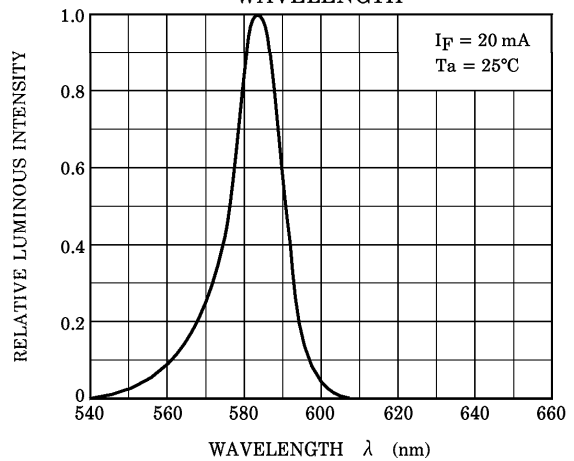

$I_F - T_a$

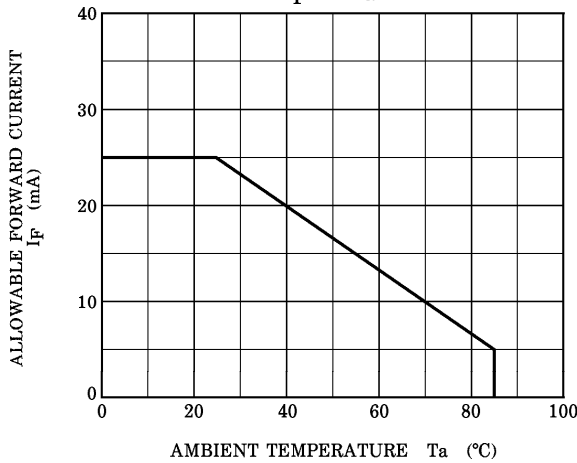

TLGE1002A

$I_F - V_F$

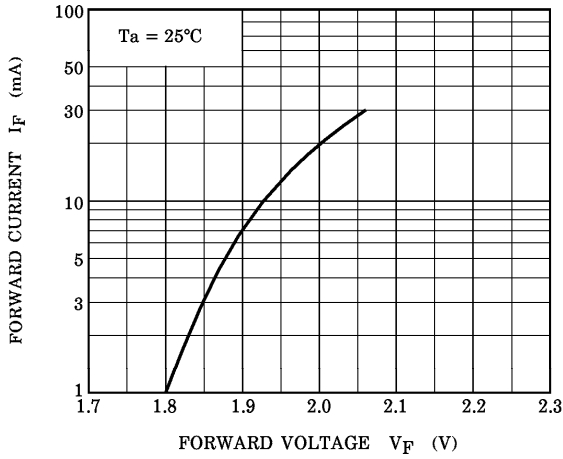

$I_V - I_F$

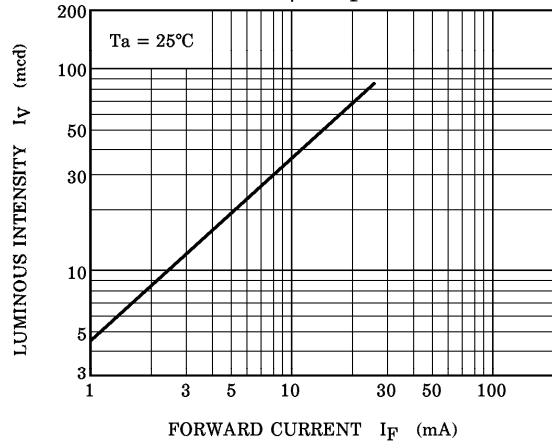

$I_V - T_c$

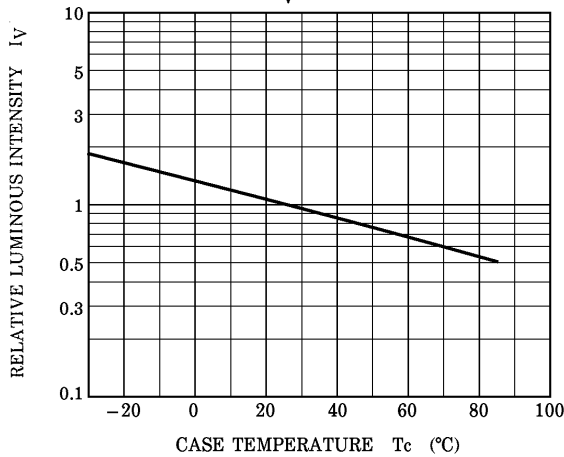

RELATIVE LUMINOUS INTENSITY - WAVELENGTH

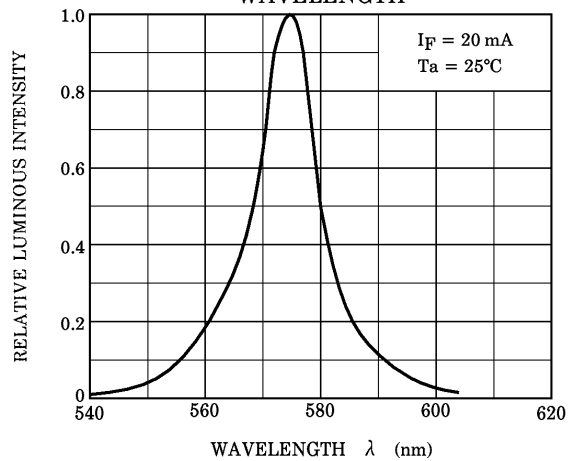

$I_F - T_a$

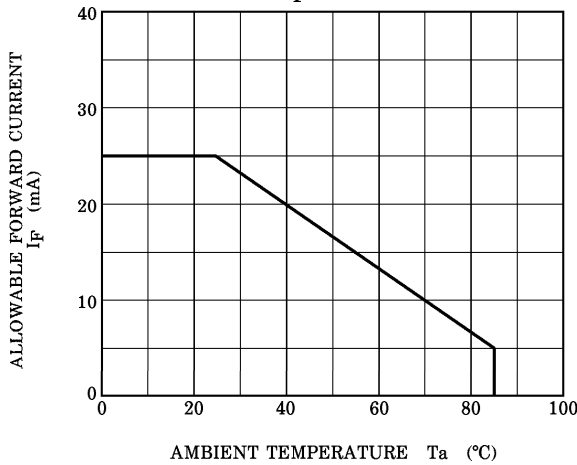

TLFGE1002A

$I_F - V_F$

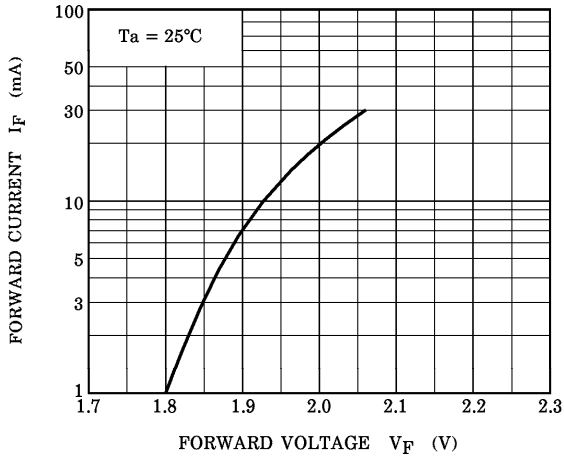

$I_V - I_F$

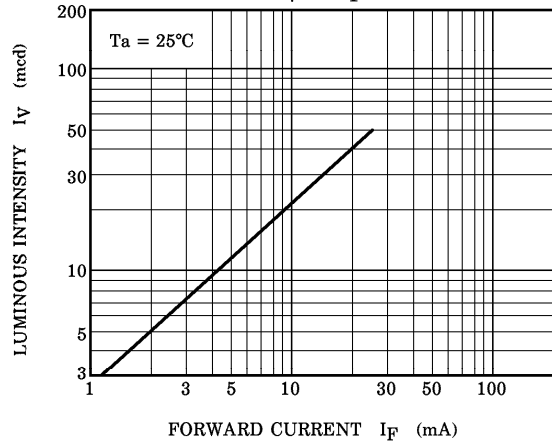

$I_V - T_c$

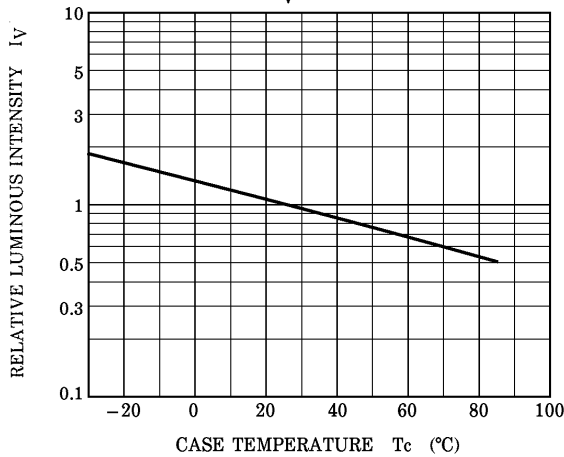

RELATIVE LUMINOUS INTENSITY - WAVELENGTH

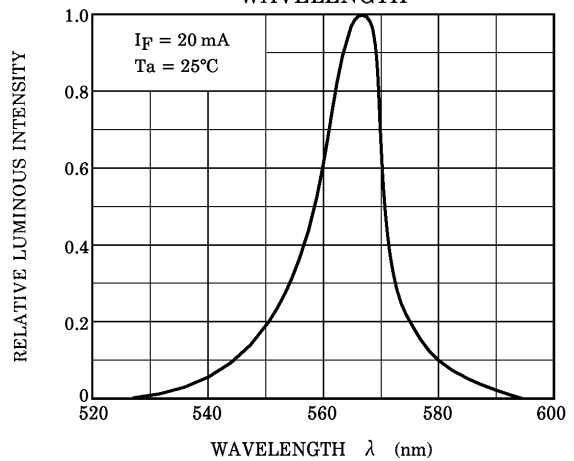

$I_F - T_a$

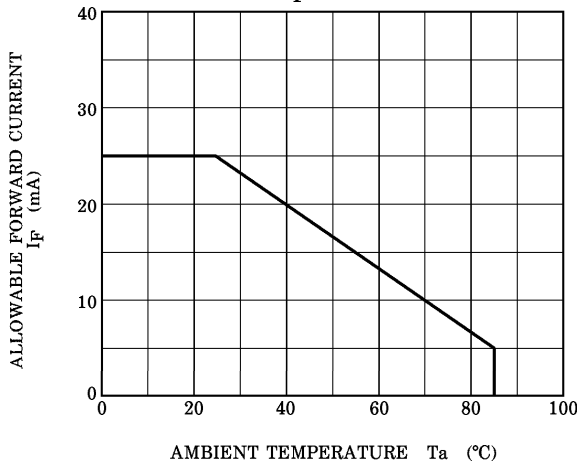

TLPGE1002A

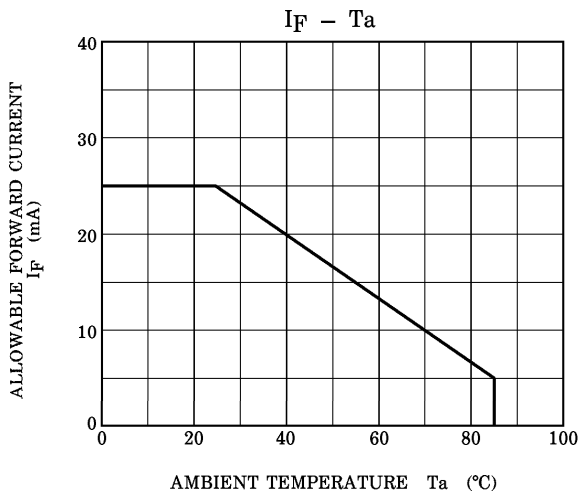
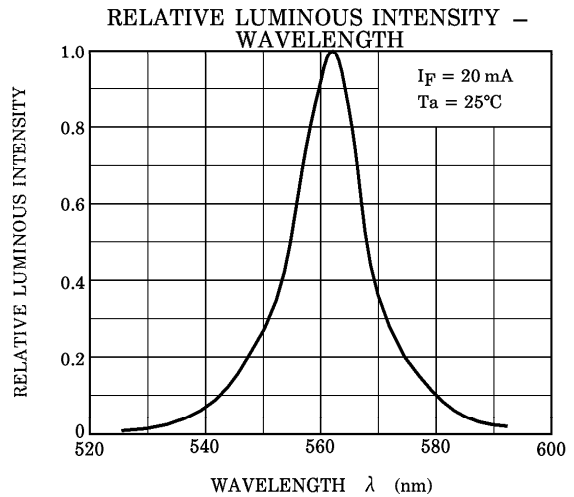
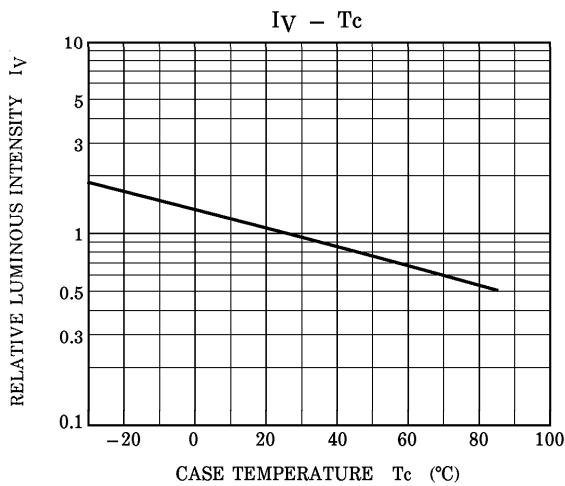
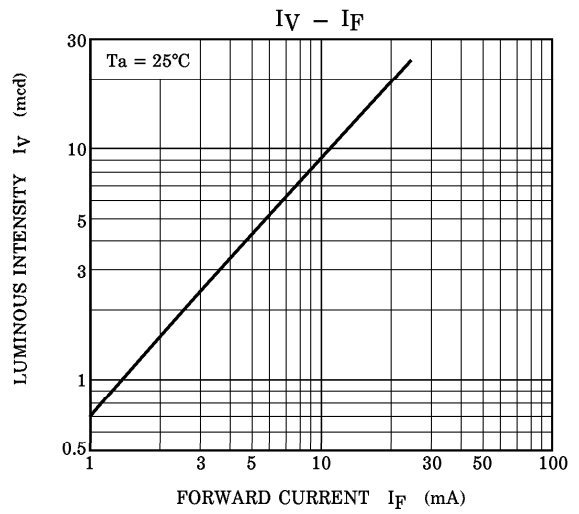
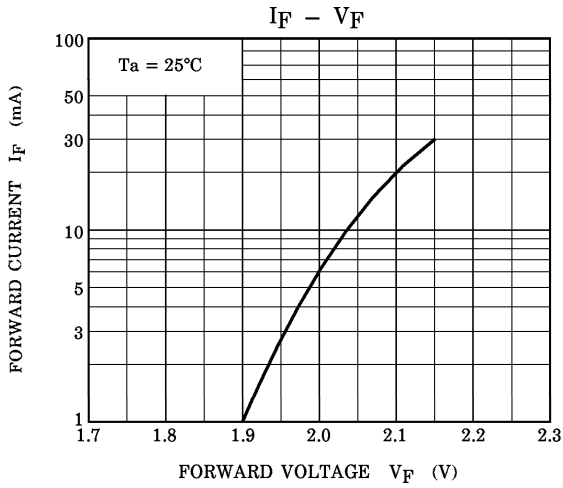

TL□E1002A SERIES
[RADIATION PATTERN]

T_a = 25°C

T_a = 25°C

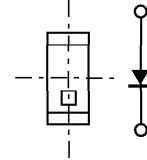
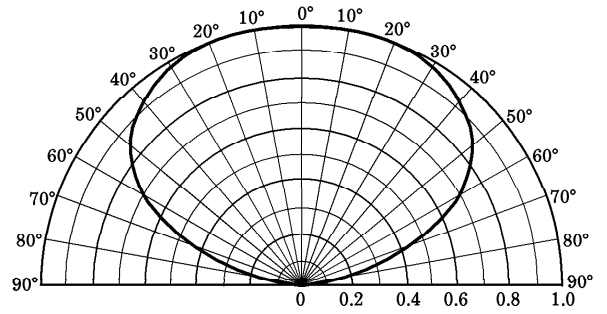
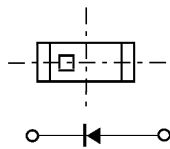
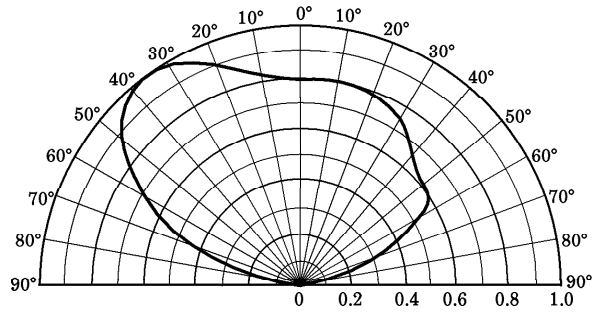

PACKAGING

These LED devices are packed in an aluminum envelope with a silica gel and a moisture indicator to avoid moisture absorption. The optical characteristics of the devices may be affected by exposure to moisture in the air before soldering and they should therefore be stored under the following conditions :

1. This moisture proof bag may be stored unopened within 12 months at the following conditions.
 Temperature : 5~30°C
 Humidity : 90% (max)
2. After opening the moisture proof bag, the devices should be assembled within 168 hours in an environment of 5°C to 30°C / 60% RH or below.
3. If upon opening, the moisture indicator card shows humidity 30% or above (Color of indication changes to pink) or the expiration date has passed, the devices should be baked in taping with reel.
 After baking, use the baked devices within 72 hours, but perform baking only once.
 Baking conditions : 60 ± 5°C, for 12 to 24 hours.
 Expiration date : 12 months from sealing date, which is imprinted on the same side as this label affixed.
4. Repeated baking can cause the peeling strength of the taping to change, then leads to trouble in mounting. Furthermore, prevent the devices from being destructed against static electricity for baking of it.
5. If the packing material of laminate would be broken, the airtightness would deteriorate. Therefore, do not throw or drop the packed devices.

MOUNTING METHOD

SOLDERING

- Reflow soldering

Temperature profile

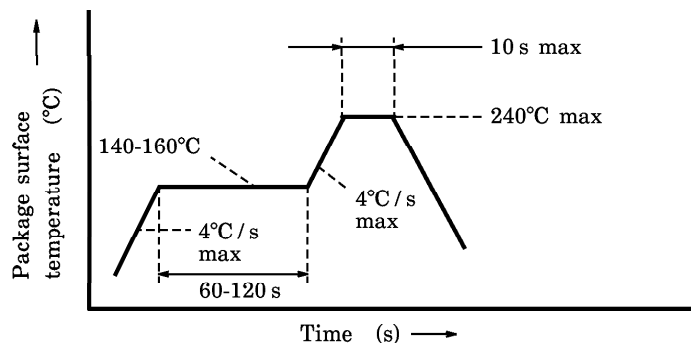

- Please perform the first reflow soldering within 168 h after opening the package with reference to the above temperature profile.



- Second time reflow soldering

In case of second reflow soldering, it should be performed within 168 h after first reflow under the above conditions.

Storage conditions before second reflow soldering : 30°C, 60% RH or lower

- Do not perform flow soldering.
- Make any necessary soldering corrections manually.
(Do not do this more than once for any given pin.)

Soldering iron : 25 W

Temperature : no more than 300°C

Time : within 3 s

- Recommended soldering pattern

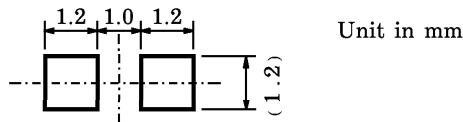

POST SOLDER CLEANING

When cleaning after soldering is needed, the following condition must be adhered to.

Cleaning solvents : AK225 or Alcohol

Temperature : 50°C (max) for 30 s (max) or 30°C (max) for 3 minutes (max)

Ultrasonic : 300 W max

PRECAUTION FOR MOUNTING

Do not apply force to the plastic part of the LED in high temperature conditions.

Do not apply friction using a hard materials for avoid injuring the plastic part of the LED.

Keep the LED away from any other parts when assembling boards into the set.

TAPING SPECIFICATIONS

This specification lays out the 4 mm pitch embossed-tape packing requirements for 2.0 mm (L) × 1.25 mm (W) × 1.1 mm (H) size surface-mount LED lamp.

1. Product Naming System

The type of package used for shipment is denoted by a symbol suffix after the product number. The method of classification is as below. (this method, however does not apply to products whose electrical characteristics differ from standard Toshiba specifications)

(1) Tape Type : T02 (4 mm pitch)

(2) Example

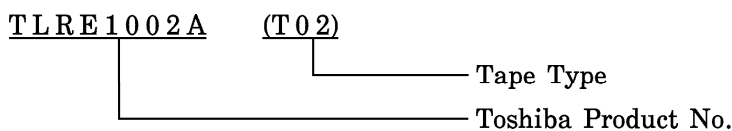

2. Related Matter

(1) Electro-optical Characteristics

Please refer to the each technical datasheet for electro-optical characteristics of tape packed products

(2) Handling Precautions

Tape material protected against static electricity. However, static electricity may occur depending on quantity of charged static electricity and a device may attach to a tape, or a device may be unstable when peeling a tape cover.

- a) In process, taping materials may sustain an electrostatic charge, use an ionizer to neutralize the ions.
- b) For transport and temporary storage of devices, use containers (boxes, jigs, bags) that are made of anti-static materials or of materials that dissipate electrostatic electricity.

3. Tape Dimensions

(Unit in mm)

SYMBOL	DIMENSION	TOLERANCE	SYMBOL	DIMENSION	TOLERANCE
D	1.50	+0.1 / -0	P ₂	2.00	±0.05
E	1.75	±0.1	W	8.00	±0.3
P ₀	4.00	±0.1	P	4.00	±0.1
t	0.25	±0.05	A ₀	1.45	±0.1
F	3.50	±0.05	B ₀	2.25	±0.1
D ₁	1.10	±0.1	K ₀	1.30	±0.05

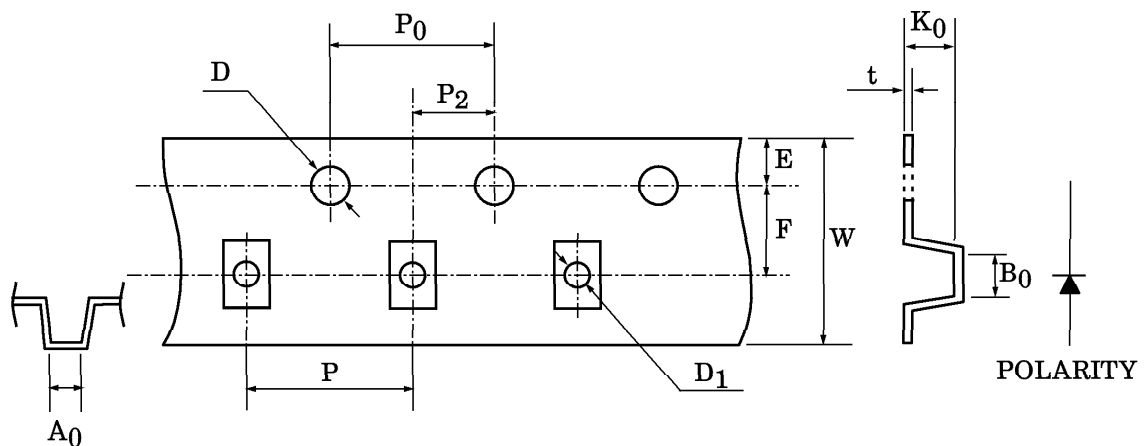

4. Reel Dimensions

Unit in mm

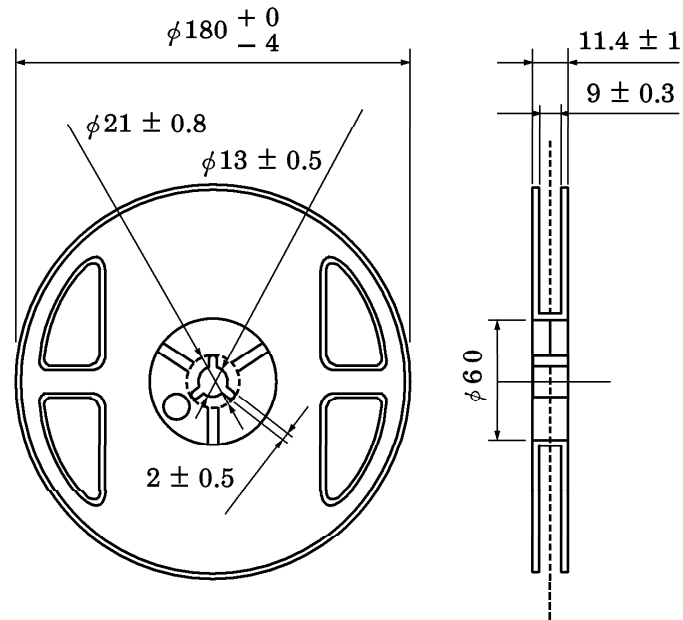

5. Leader and Trailer

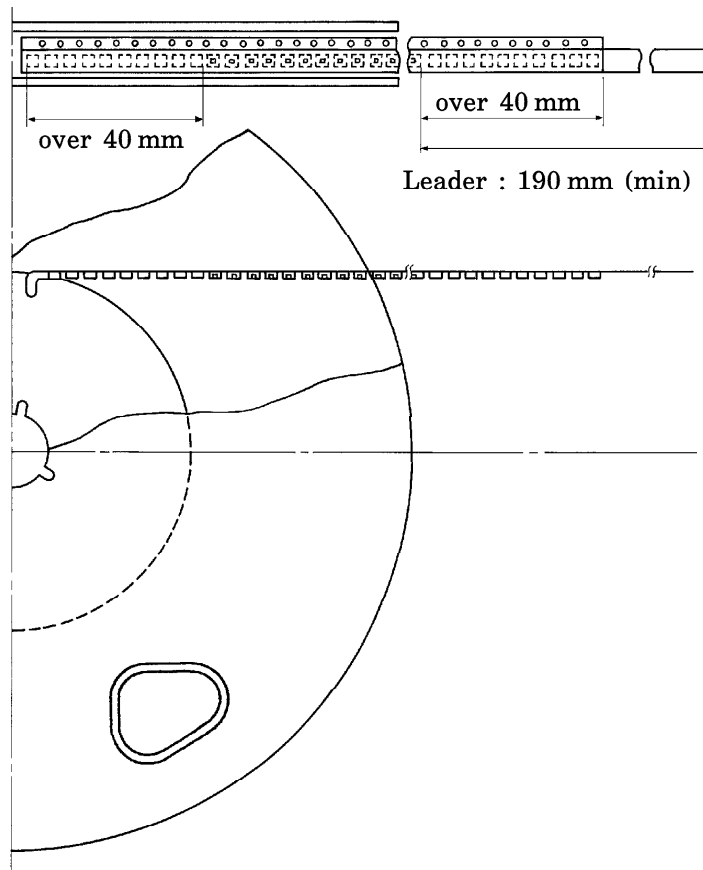

6. Packing Form

(1) Number of Devices per Reel and Carton

Reel	3000 devices
Carton	15000 devices

(2) Packing : Silica gel and reel are packed into sealed aluminum pack.

7. Notation Method

(1) Example : TLRE1002A (T02)

P/N :

TYPE	TLRE1002A		
ADD. C	(T02)	Q'TY	3000 pcs
NOTE (rank symbol)	Lot Number		

(2) Label location :

• Reel

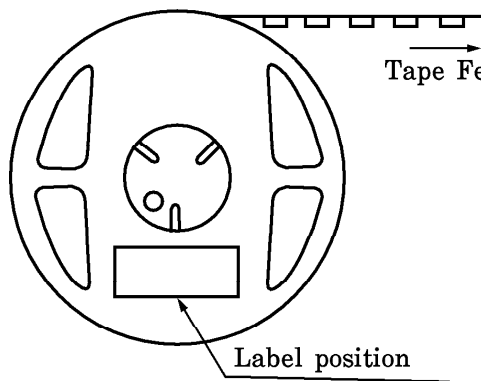

• Carton

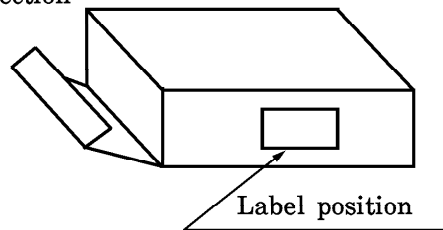

• Aluminum pack : Attached to center of one side



RESTRICTIONS ON PRODUCT USE

000707EAC

- TOSHIBA is continually working to improve the quality and reliability of its products. Nevertheless, semiconductor devices in general can malfunction or fail due to their inherent electrical sensitivity and vulnerability to physical stress. It is the responsibility of the buyer, when utilizing TOSHIBA products, to comply with the standards of safety in making a safe design for the entire system, and to avoid situations in which a malfunction or failure of such TOSHIBA products could cause loss of human life, bodily injury or damage to property. In developing your designs, please ensure that TOSHIBA products are used within specified operating ranges as set forth in the most recent TOSHIBA products specifications. Also, please keep in mind the precautions and conditions set forth in the "Handling Guide for Semiconductor Devices," or "TOSHIBA Semiconductor Reliability Handbook" etc..
- The TOSHIBA products listed in this document are intended for usage in general electronics applications (computer, personal equipment, office equipment, measuring equipment, industrial robotics, domestic appliances, etc.). These TOSHIBA products are neither intended nor warranted for usage in equipment that requires extraordinarily high quality and/or reliability or a malfunction or failure of which may cause loss of human life or bodily injury ("Unintended Usage"). Unintended Usage include atomic energy control instruments, airplane or spaceship instruments, transportation instruments, traffic signal instruments, combustion control instruments, medical instruments, all types of safety devices, etc.. Unintended Usage of TOSHIBA products listed in this document shall be made at the customer's own risk.
- Gallium arsenide (GaAs) is a substance used in the products described in this document. GaAs dust and fumes are toxic. Do not break, cut or pulverize the product, or use chemicals to dissolve them. When disposing of the products, follow the appropriate regulations. Do not dispose of the products with other industrial waste or with domestic garbage.
- The information contained herein is presented only as a guide for the applications of our products. No responsibility is assumed by TOSHIBA CORPORATION for any infringements of intellectual property or other rights of the third parties which may result from its use. No license is granted by implication or otherwise under any intellectual property or other rights of TOSHIBA CORPORATION or others.
- The information contained herein is subject to change without notice.

