

MOSPEC

SWITCHMODE SERIES NPN POWER TRANSISTORS

... designed for use in high-voltage, high-speed, power switching in inductive circuit, they are particularly suited for 115 and 220 V switchmode applications such as switching regulator's, inverters, DC -DC and converter

FEATURES:

*Collector-Emitter Sustaining Voltage-

$$V_{CE(sus)} = 400 \text{ V (Min)}$$

* Collector-Emitter Saturation Voltage -

$$V_{CE(sat)} = 1.0 \text{ V (Max.) @ } I_C = 4.0 \text{ A, } I_B = 0.8 \text{ A}$$

* Switching Time - $t_f = 1.0 \text{ us (Max.) @ } I_C = 5.0 \text{ A}$

NPN
2SC3039

7.0 AMPERE
SILICON POWER
TRANSISTORS
400 VOLTS
50 WATTS

MAXIMUM RATINGS

Characteristic	Symbol	2SC3039	Unit
Collector-Emitter Voltage	V_{CEO}	400	V
Collector-Base Voltage	V_{CBO}	500	V
Emitter-Base Voltage	V_{EBO}	7.0	V
Collector Current - Continuous - Peak	I_C I_{CM}	7.0 14	A
Base current	I_B	3.0	A
Total Power Dissipation @ $T_C = 25^\circ\text{C}$ Derate above 25°C	P_D	50 0.4	W W/ $^\circ\text{C}$
Operating and Storage Junction Temperature Range	T_J, T_{STG}	-55 to +150	$^\circ\text{C}$

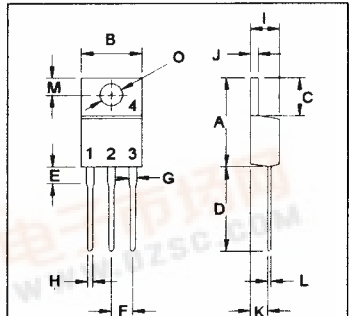
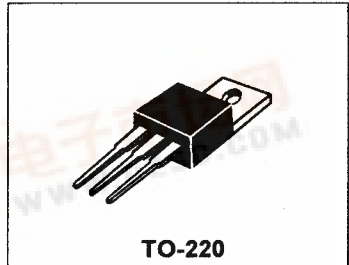

PIN 1.BASE
2.COLLECTOR
3.EMITTER
4.COLLECTOR(CASE)

THERMAL CHARACTERISTICS

Characteristic	Symbol	Max	Unit
Thermal Resistance Junction to Case	$R_{\theta jc}$	2.5	$^\circ\text{C/W}$

DIM	MILLIMETERS	
	MIN	MAX
A	14.68	15.31
B	9.78	10.42
C	5.01	6.52
D	13.06	14.62
E	3.57	4.07
F	2.42	3.66
G	1.12	1.36
H	0.72	0.96
I	4.22	4.98
J	1.14	1.38
K	2.20	2.97
L	0.33	0.55
M	2.48	2.98
O	3.70	3.90

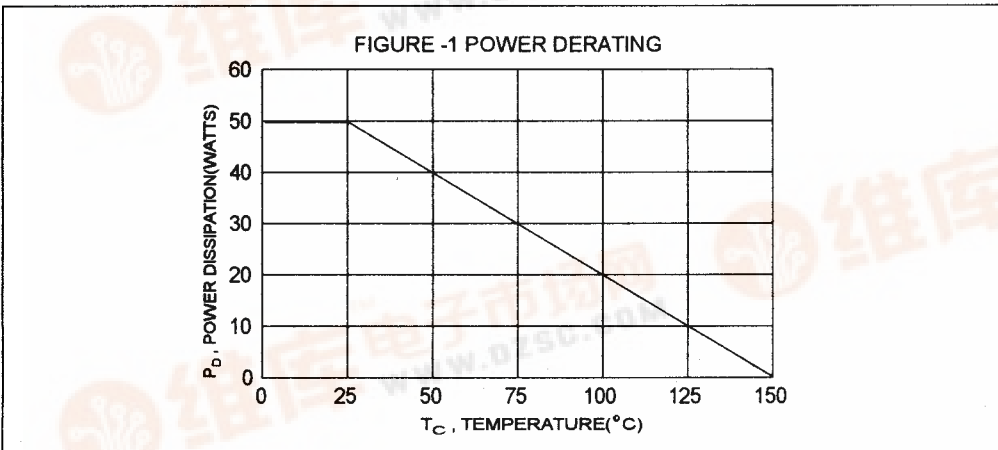

ELECTRICAL CHARACTERISTICS ($T_c = 25^\circ\text{C}$ unless otherwise noted)

Characteristic	Symbol	Min	Max	Unit
----------------	--------	-----	-----	------

OFF CHARACTERISTICS

Collector-Emitter Sustaining Voltage ($I_C = 7.0\text{ A}$, $I_{B1} = 1.4\text{ A}$, $L = 50\text{ }\mu\text{H}$)	$V_{CE(sus)}$	400		V
Collector-Base Breakdown Voltage ($I_C = 1.0\text{ mA}$, $I_E = 0$)	$V_{(BR)CBO}$	500		V
Collector-Emitter Breakdown Voltage ($I_C = 5.0\text{ mA}$, $I_B = 0$)	$V_{(BR)CEO}$	400		V
Emitter-Base Breakdown Voltage ($I_E = 1.0\text{ mA}$, $I_C = 0$)	$V_{(BR)EBO}$	7.0		V
Collector Cutoff Current ($V_{CB} = 400\text{ V}$, $I_E = 0$)	I_{CBO}		10	μA
Emitter Cutoff Current ($V_{EB} = 5.0\text{ V}$, $I_C = 0$)	I_{EBO}		10	μA

ON CHARACTERISTICS (1)

DC Current Gain ($I_C = 0.8\text{ A}$, $V_{CE} = 5.0\text{ V}$) ($I_C = 4.0\text{ A}$, $V_{CE} = 5.0\text{ V}$)	$h_{FE(2)}$ h_{FE}	15 8.0	50	
Collector-Emitter Saturation Voltage ($I_C = 4.0\text{ A}$, $I_B = 800\text{ mA}$)	$V_{CE(sat)}$		1.0	V
Base-Emitter Saturation Voltage ($I_C = 4.0\text{ A}$, $I_B = 800\text{ mA}$)	$V_{BE(sat)}$		1.5	V

SWITCHING CHARACTERISTICS

On Time	$V_{CC} = 200\text{ V}$, $I_C = 5.0\text{ A}$ $I_{B1} = -I_{B2} = 1.0\text{ A}$ $R_L = 40\text{ }\Omega$	t_{on}	1.0	μs
Storage Time		t_s	2.5	μs
Fall Time		t_f	1.0	μs

(1) Pulse Test: Pulse Width = 300 μs , Duty Cycle $\leq 2.0\%$,
* $h_{FE(2)}$ Classification: L : 15 --- 30 ; M : 20 --- 40 ; N : 30 --- 50

SAFE OPERATING AREA

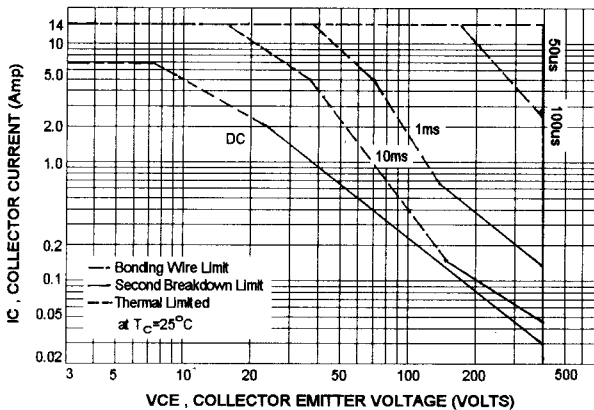

REVERSE BIASE SAFE OPERATING AREA

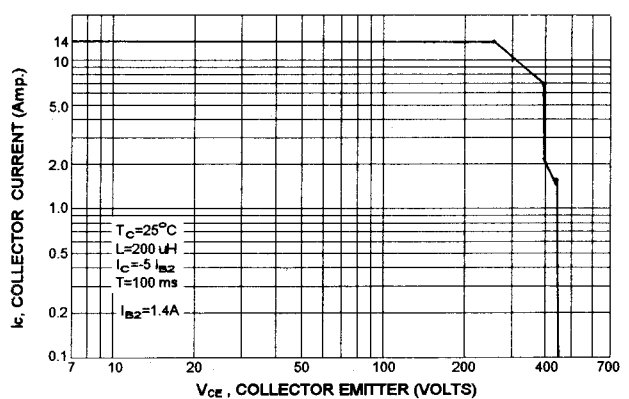

$I_c - V_{ce}$

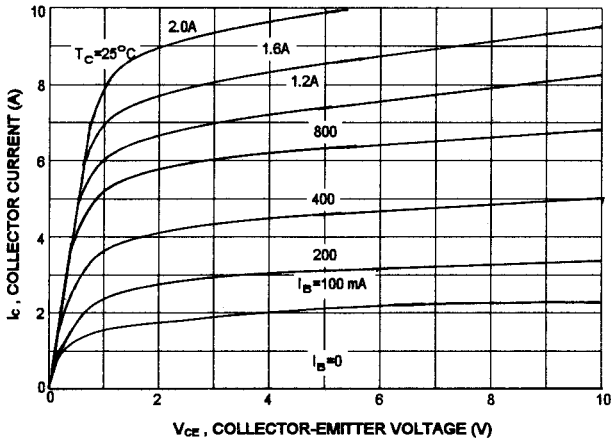

DC CURRENT GAIN

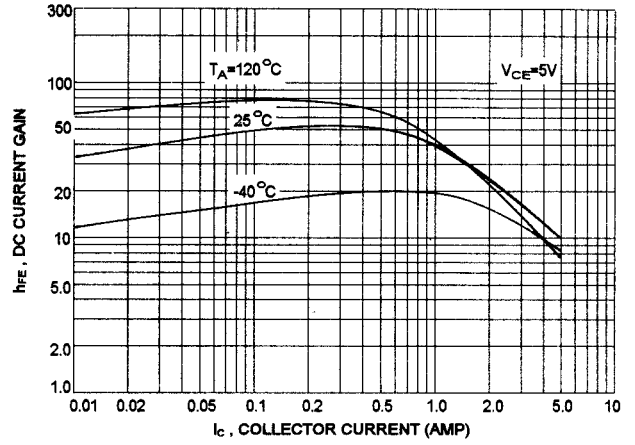

$I_c - V_{be}$

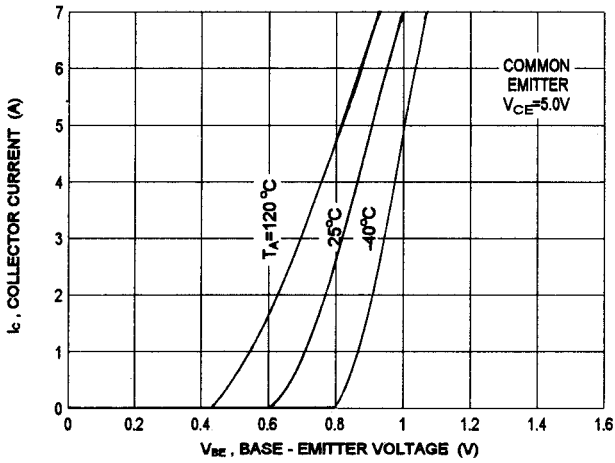

$V_{ce} - I_c$

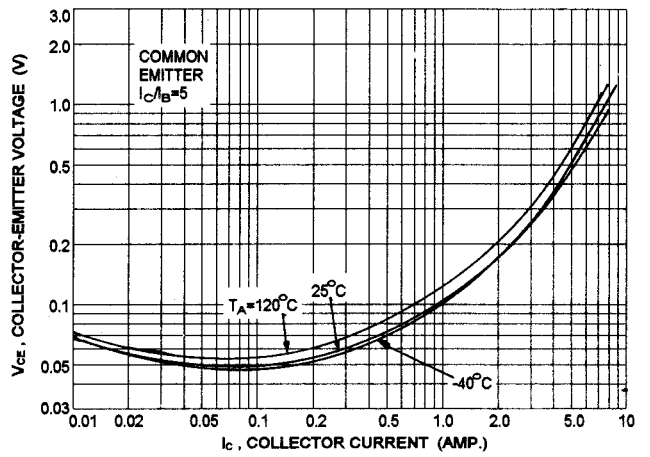

SWITCHING TIME

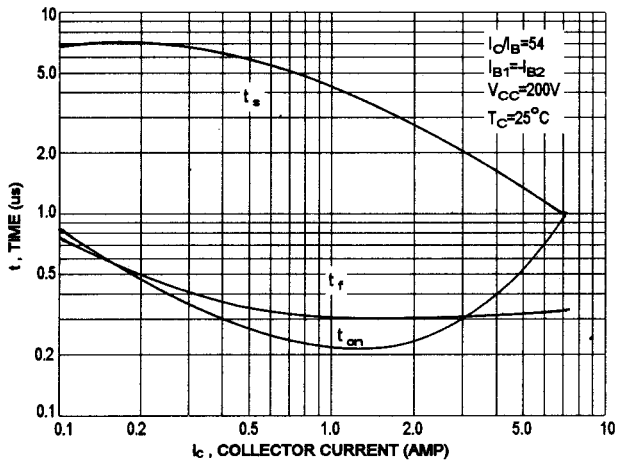

$V_{be} - I_c$

