



Product Description

Sirenza Microdevices' SZP-3026Z is a high linearity single stage class AB Heterojunction Bipolar Transistor (HBT) amplifier housed in a proprietary surface-mountable plastic encapsulated package. This HBT amplifier is made with InGaP on GaAs device technology and fabricated with MOCVD for an ideal combination of low cost and high reliability.

This product is specifically designed as a flexible final or driver stage for 802.16 equipment in the 2.7-3.8GHz bands. It can run from a 3V to 6V supply. It is prematched to ~5 ohms on the input for broadband performance and ease of matching at the board level. It features an output power detector, on/off power control, ESD protection, excellent overall robustness and a proprietary hand reworkable and thermally enhanced SOF-26 package. This product features a RoHS Compliant and Green package with matte tin finish, designated by the 'Z' suffix.

Functional Block Diagram

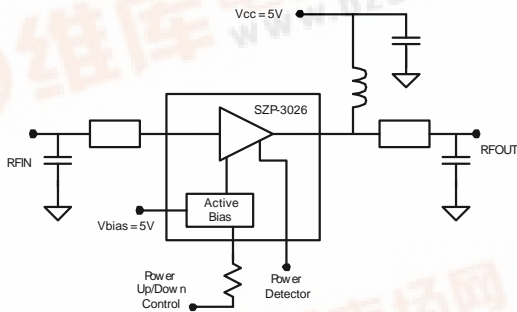

Key Specifications

Symbol	Parameters: Test Conditions, 3.4-3.6GHz App circuit, $Z_0 = 50\Omega$, $V_{CC} = 5.0V$, $I_q = 460mA$, $T_{BP} = 30^\circ C$	Unit	Min.	Typ.	Max.
f_O	Frequency of Operation	MHz	2700		3800
P_{1dB}	Output Power at 1dB Compression - 3.5GHz	dBm	32.0	33.5	
S_{21}	Small Signal Gain - 3.5GHz	dB	10.3	11.8	
P_{out}	Output power at 2.5% EVM 802.11g 54Mb/s - 3.5GHz	dBm		26.0	
IM3	Third Order Suppression ($P_{out}=23dBm$ per tone) - 3.5GHz	dBc		-44	-41
NF	Noise Figure at 3.5GHz	dB		5.9	
IRL	Worst Case Input Return Loss 3.4-3.6GHz	dB	10	14	
ORL	Worst Case Output Return Loss 3.4-3.6GHz		6	9	
Vdet Range	Output Voltage Range for $P_{out}=10dBm$ to 33dBm	V		0.9 to 2.2	
I_{cq}	Quiescent Current ($V_{cc} = 5V$)	mA	415	460	510
I_{VPC}	Power Up Control Current ($V_{pc}=5V$)	mA		2.3	
I_{leak}	V_{cc} Leakage Current ($V_{cc} = 5V$, $V_{pc} = 0V$)	μA			10
$R_{th, j-l}$	Thermal Resistance (junction - lead)	$^\circ C/W$		12	

The information provided herein is believed to be reliable at press time. Sirenza Microdevices assumes no responsibility for inaccuracies or omissions. Sirenza Microdevices assumes no responsibility for the use of this information, and all such information shall be entirely at the user's own risk. Prices and specifications are subject to change without notice. No patent rights or licenses to any of the circuits described herein are implied or granted to any third party. Sirenza Microdevices does not authorize or warrant any Sirenza Microdevices product for use in life-support devices and/or systems.

Copyright 2002 Sirenza Microdevices, Inc. All worldwide rights reserved.
303 South Technology Court Broomfield, CO 80021

Phone: (800) SMI-MMIC

1

http://www.sirenza.com
EDS-104666 Rev B

Preliminary

SZP-3026Z

2.7-3.8GHz 2W InGaP Amplifier

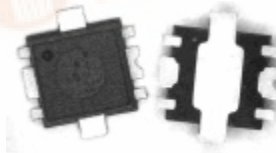

Proprietary SOF-26 Package

Product Features

- $P_{1dB} = 33.5dBm @ 5V$
- 802.11g 54Mb/s Class AB Performance
 $P_{out} = 26dBm @ 2.5\% EVM, V_{cc} 5V, 570mA$
 $P_{out} = 27dBm @ 2.5\% EVM, V_{cc} 6V, 590mA$
- On-chip Output Power Detector
- Input Prematched to ~5 ohms
- Proprietary Low Thermal Resistance Package
Hand Solderable and Easy Rework
- Power up/down control < 1 μs

Applications

- 802.16 WiMAX Driver or Output Stage
- WLL

Typical Performance with Appropriate App Circuit (Vcc=5V, Icq=460mA, * 802.11g 54Mb/s)

Parameter	Units	2.7GHz	3.0GHz	3.3GHz	3.4GHz	3.5GHz	3.7GHz	3.8GHz
Gain@Pout=26dBm	dB	13	12.5	12.1	12.0	11.9	11.1	10.4
P1dB	dBm	33.5	33.5	33.6	33.9	33.6	32.7	32.3
Pout @ 2.5% EVM*	dBm	26	26	26	26	26	25.5	25
Current @ Pout 2.5% EVM*	mA	590	590	580	580	570	560	550
Input Return Loss	dB	15	15	17	16	15	12	12
Output Return Loss	dB	9	9	9	9	10	9	9

Pin Out Description

Pin #	Function	Description
1	VBIAS	This is the supply voltage for the active bias circuit.
2	RFIN	This is the RF input pin and has a DC voltage present. An external DC block is required.
3	VPC	Power up/down control pin. The voltage on this pin should never exceed the voltage on pin 3 by more than 0.5V unless the supply current from pin 3 is limited < 10mA.
4	VDET	This is the output port for the power detector. It samples the power at the input of the amplifier.
5	RFOUT/VCC	This is the RF output pin and DC connection to the collector.
6	NC	This pin is not connected internal to the package. Buss it to pin 5 as shown on the app circuit to achieve the specified performance.
GND	GND	These pins are DC connected to the backside paddle. They provide good thermal connection to the backside paddle for hand soldering and rework. Many thermal and electrical GND vias are recommended as shown in the landing pattern.

Absolute Maximum Ratings

Parameters	Value	Unit
VC1 Collector Bias Current (I _{VC1})	1500	mA
Device Voltage (V _{CC})	7.0	V
Power Dissipation	6	W
Operating Lead Temperature (T _L)	-40 to +85	°C
Max RF Input Power for 50 ohm output load	27	dBm
Max RF Input Power for 10:1 VSWR output load	23	dBm
Storage Temperature Range	-40 to +150	°C
Operating Junction Temperature (T _J)	+150	°C
ESD Human Body Model	500	V

Operation of this device beyond any one of these limits may cause permanent damage. For reliable continuous operation the device voltage and current must not exceed the maximum operating values specified in the table on page one.

Bias conditions should also satisfy the following expression:

$$I_D V_D < (T_J - T_L) / R_{TH} J^{-1}$$

Simplified Device Schematic

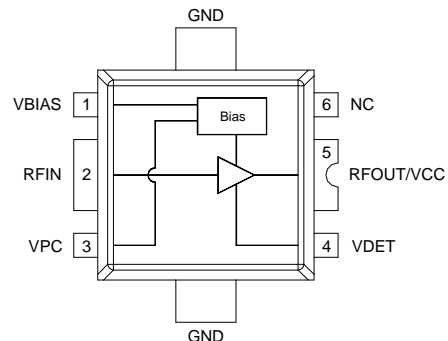

Caution: ESD Sensitive

Appropriate precaution in handling, packaging and testing devices must be observed.





Preliminary
SZP-3026Z 2.7-3.8GHz 2W Power Amp

Measured 3.4-3.6 GHz Application Circuit Data ($V_{CC} = V_{PC} = 5.0V$, $I_q = 460mA$, $T=25C$)

Source EVM = 0.6%, not deembedded from data.

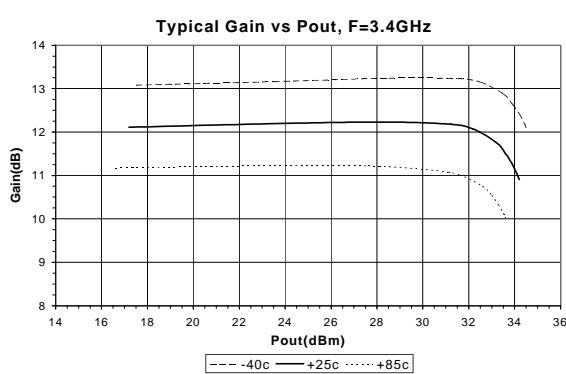
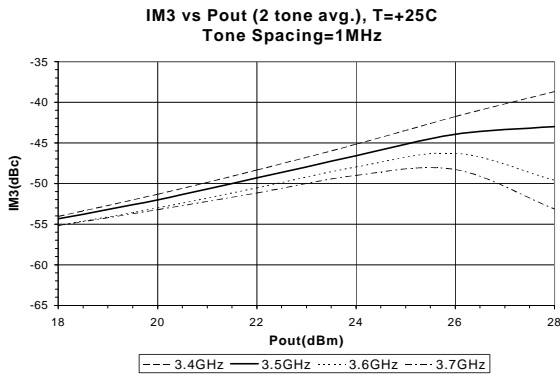
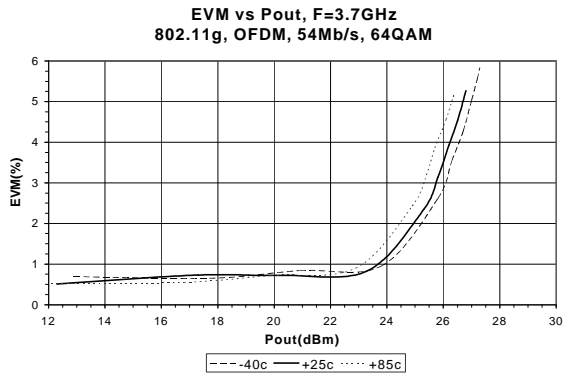
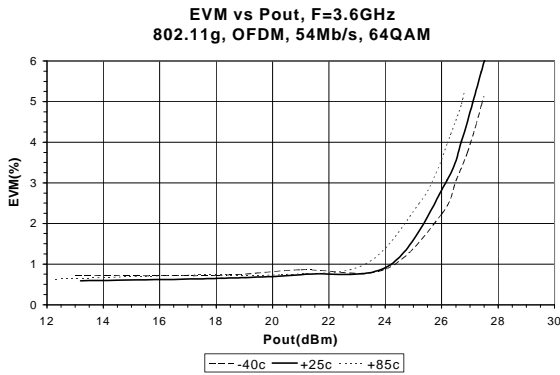
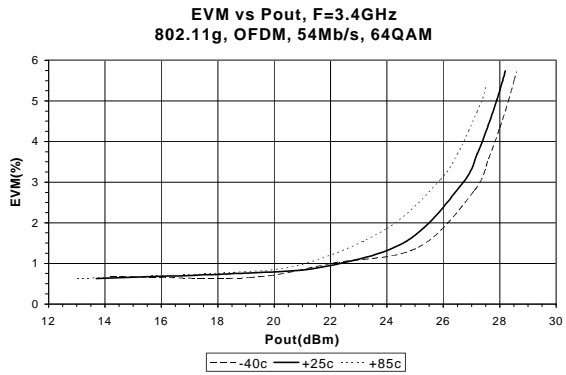
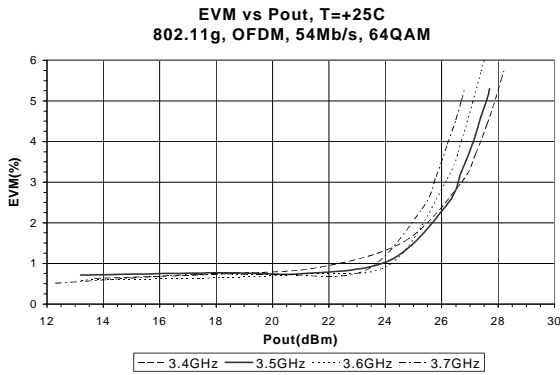



Preliminary
SZP-3026Z 2.7-3.8GHz 2W Power Amp

Measured 3.4-3.6 GHz Application Circuit Data ($V_{CC} = V_{PC} = 5.0V$, $I_q = 460mA$, $T=25C$)

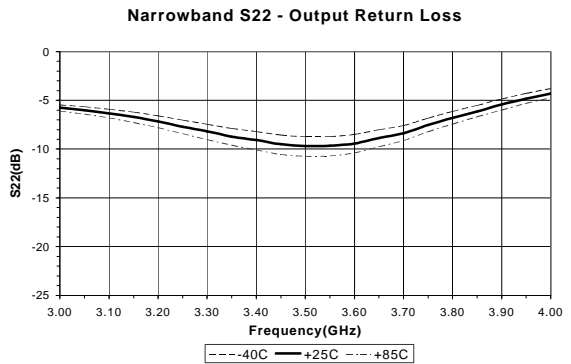
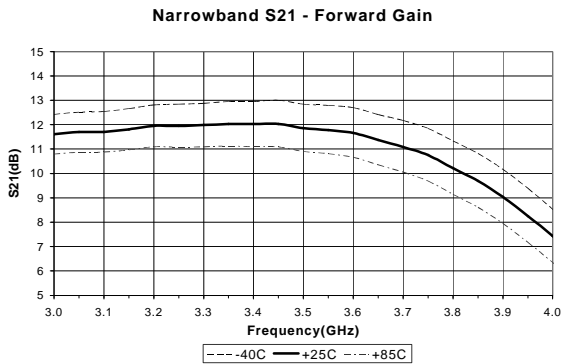
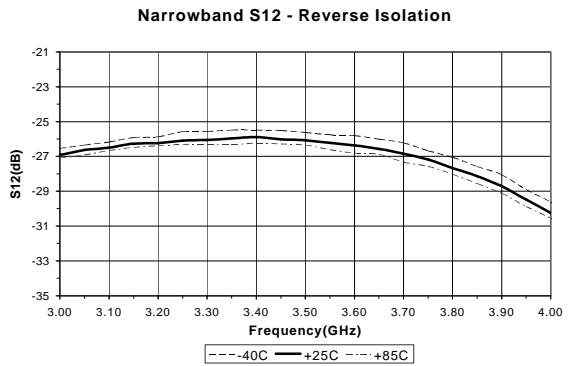
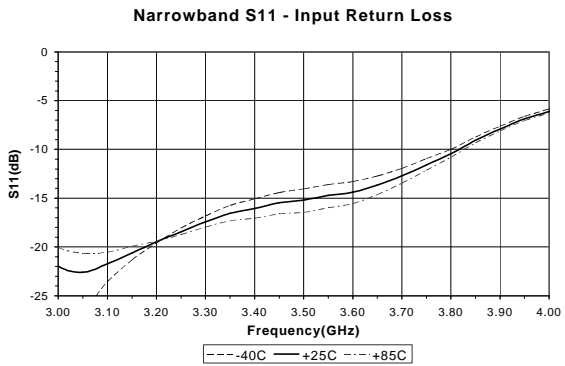
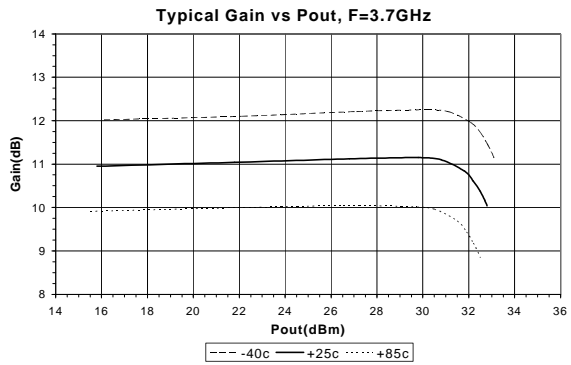
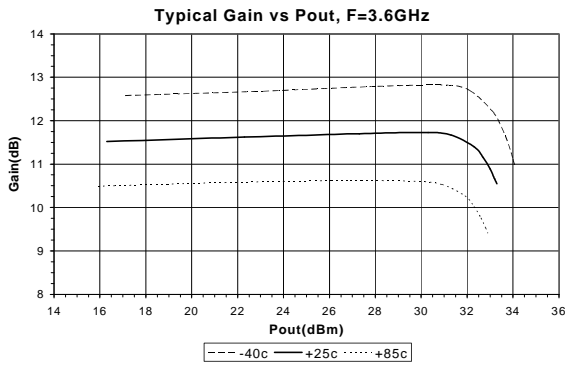



Preliminary
SZP-3026Z 2.7-3.8GHz 2W Power Amp

Measured 3.4-3.6 GHz Application Circuit Data ($V_{CC} = V_{PC} = 5.0V$, $I_q = 460mA$, $T=25C$)

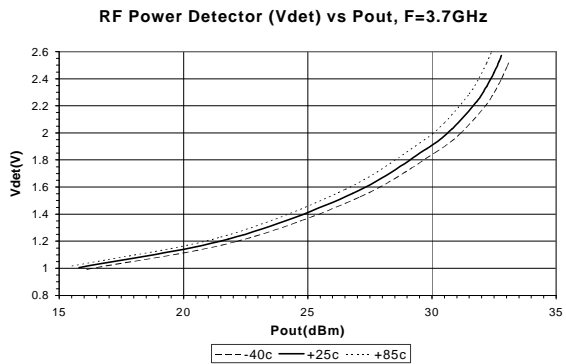
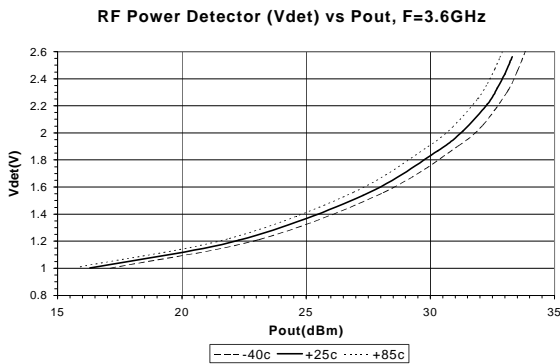
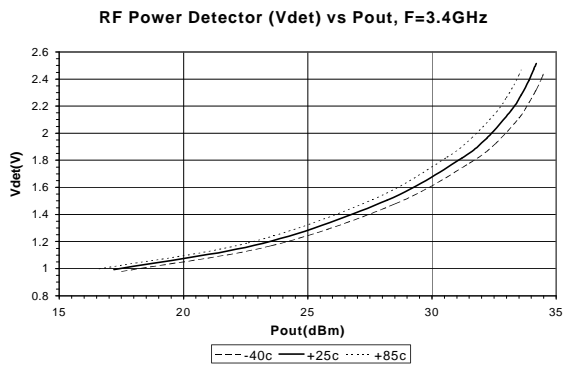
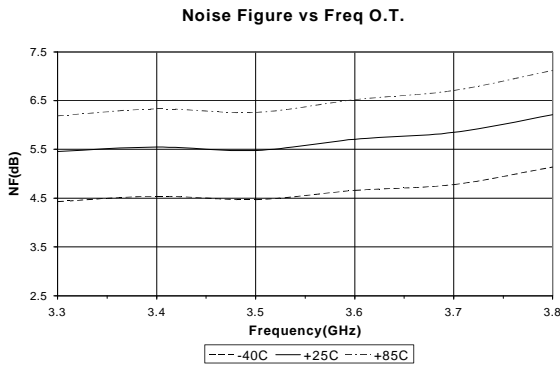
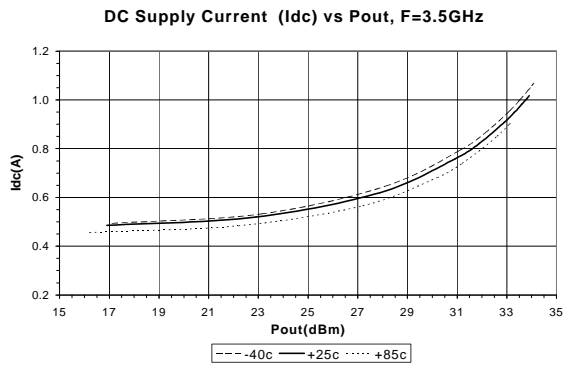
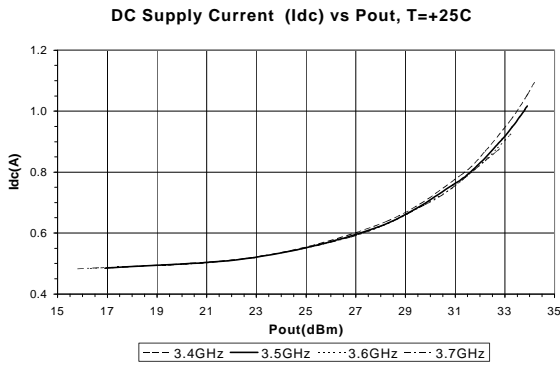



Preliminary
SZP-3026Z 2.7-3.8GHz 2W Power Amp

Measured 3.4-3.6 GHz Application Circuit Data ($V_{CC} = V_{PC} = 5.0V$, $I_q = 460mA$, $T=25C$)

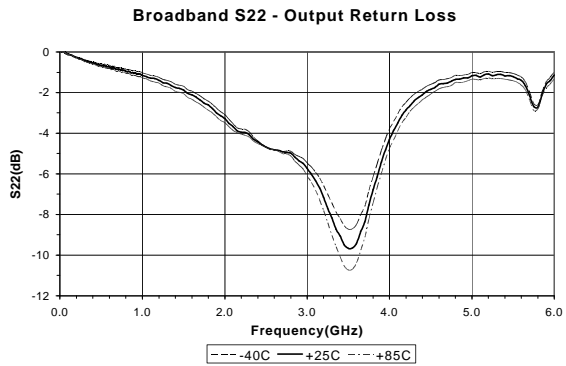
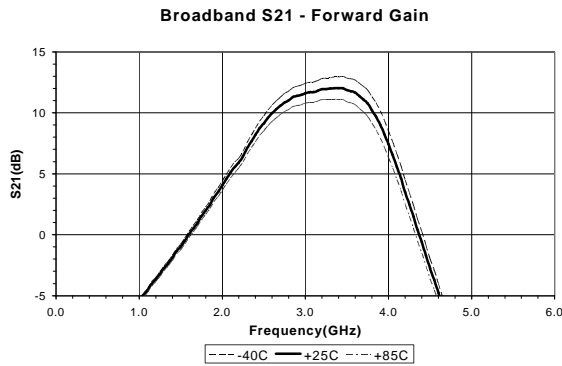
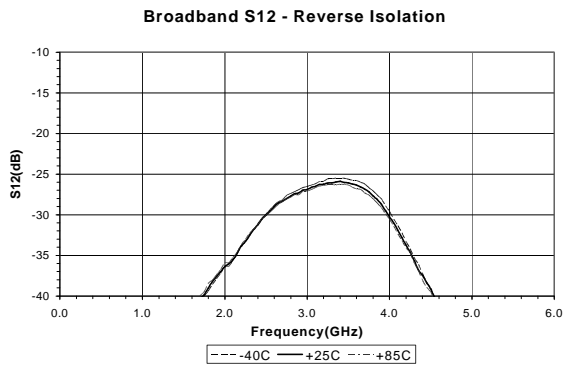
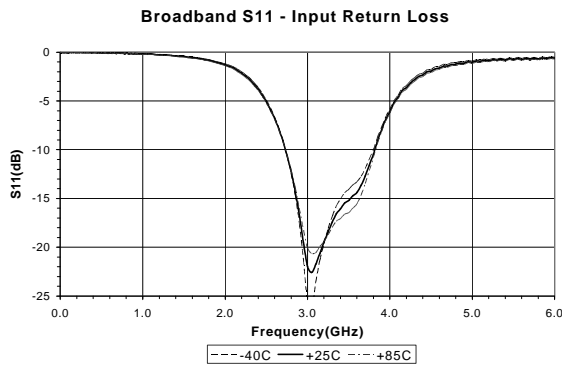

3.4-3.6 GHz Evaluation Board Schematic For $V_+ = V_{cc} = V_{pc} = 5.0V$, $I_q=460mA$

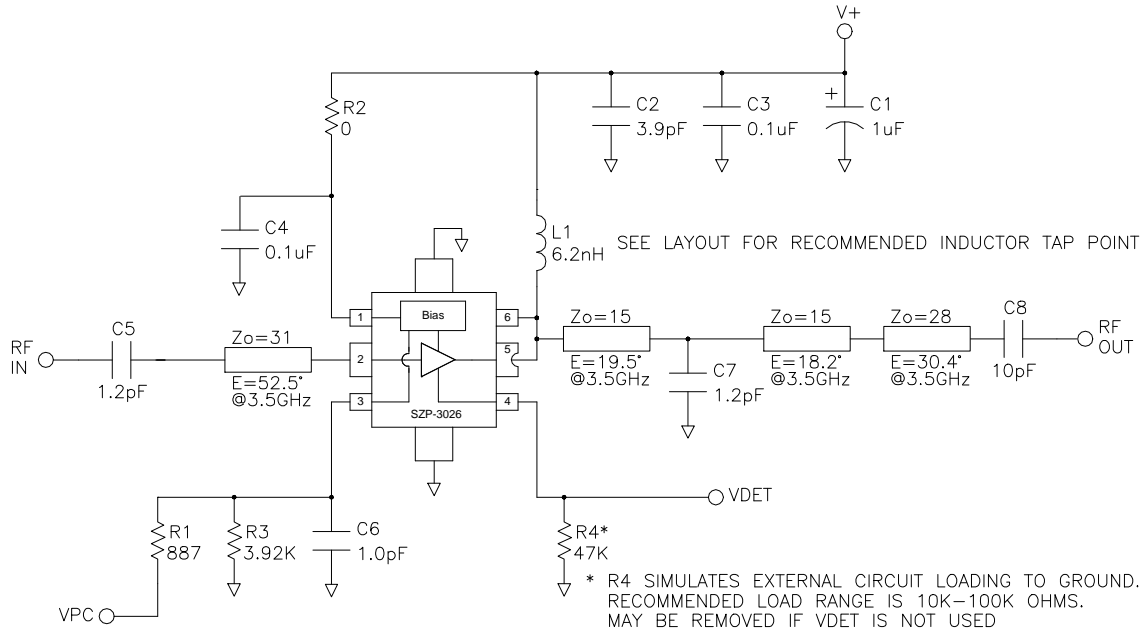

3.4-3.6GHz Evaluation Board Layout For $V_+ = V_{cc} = V_{pc} = 5.0V$, $I_q=460mA$

Board material GETEK, 10mil thick, Dk=3.9, 2 oz. copper

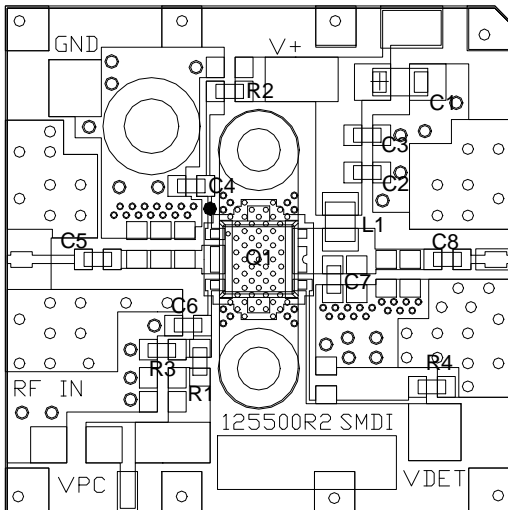

DESG	DESCRIPTION	NOTES
Q1	SZP-3026	SOF-26
R1	887 OHM, 0603 1%	0402 may be used
R2	0 OHM, 0603	"
R3	3.92K OHM, 0603 1%	"
R4	47K OHM, 0603	"
C1	1uF 16V MLCC CAP	Tantalum ok for EVM performance. Use MLCC type for best IM3 levels.
C2	3.9pF CAP, 0603	NPO, ROHM MCH185A3R9DK or equiv.
C3,4	0.1uF CAP, 0603	NPO, 0402 ok ROHM MCH184CN105K or equiv.
C5	1.2pF CAP, 0603	NPO, low ESR ATC 600S1R2CW250 or equiv.
C6	1.0pF CAP, 0603	NPO, 0402 ok ROHM MCH185A1R0DK or equiv.
C7	1.2pF CAP, 0603	NPO, low ESR ATC 600S1R2CW250 or equiv.
C8	10pF CAP, 0603	NPO, low ESR ATC 600S100JW250 or equiv.
L1	6.2nH IND, 0805	Coilcraft 0805HQ-6N2XJBB



Preliminary
SZP-3026Z 2.7-3.8GHz 2W Power Amp

Part Symbolization

The part will be symbolized with a "SZP-3026Z" to designate it as a RoHS green compliant product. Marking designator will be on the top surface of the package.

Part Number Ordering Information

Part Number	Reel Size	Devices/Reel
SZP-3026Z*	13"	3000

* Matte tin finish

Package Outline Drawing (dimensions in mm [in]):

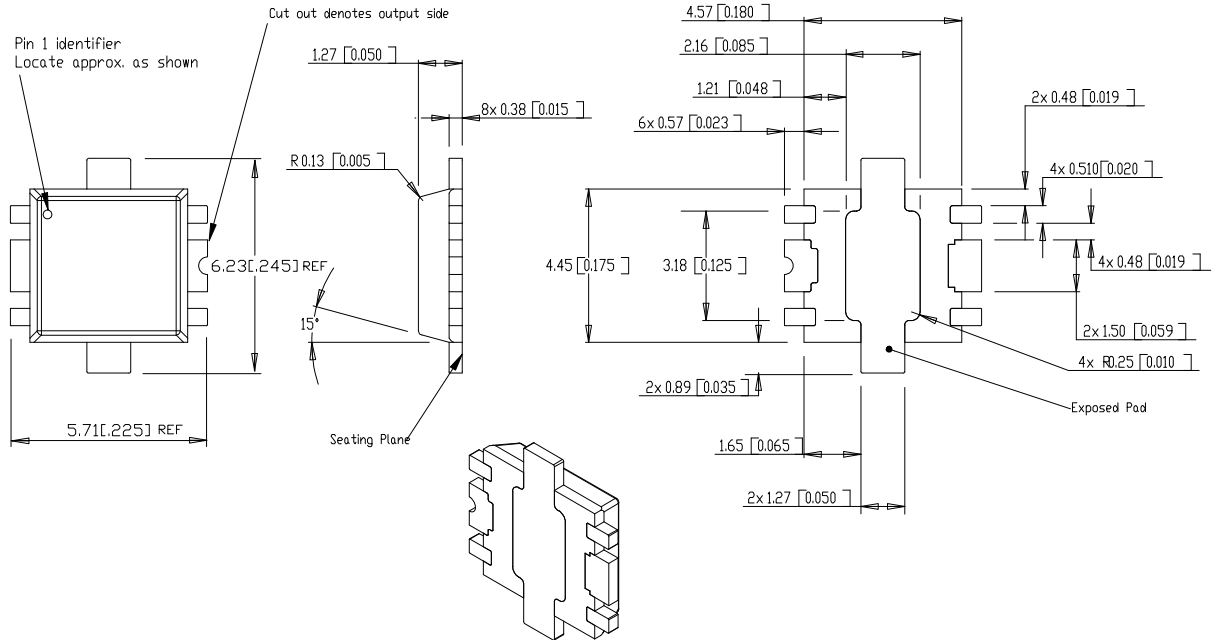

Recommended Metal Land Pattern (dimensions in mm [in]):

