

Lucent Technologies
Bell Labs Innovations



JC030-Series Power Modules: 18 Vdc to 36 Vdc Inputs; 30 W



The JC030-Series Power Modules use advanced, surface-mount technology and deliver high-quality, compact, dc-dc conversion at an economical price.

Features

- Small size: 2.40 in. x 2.28 in. x 0.50 in.
- Low output noise
- Constant frequency
- Industry-standard pinout
- Metal case
- 2:1 input voltage range
- Remote sense
- Remote on/off
- High efficiency: 81% typical
- Adjustable output voltage
- UL* Recognized, CSA† Certified, and VDE Licensed
- Within FCC and VDE Class A radiated limits

Applications

- Distributed power architectures
- Telecommunication

Options

- Choice of on/off configuration
- Short pin (0.110 in. ± 0.010 in.)
- Heat sink available for extended operation

Description

The JC030A-M, B-M, and C-M Power Modules are dc-dc converters that operate over an input voltage range of 18 Vdc to 36 Vdc and provide precisely regulated 5 V, 12 V, and 15 V outputs, respectively. The outputs are isolated from the inputs, allowing versatile polarity configurations and grounding connections. The modules have maximum power ratings of 30 W at a typical full-load efficiency of 81%.

The power modules feature remote on/off, output sense (both negative and positive leads), and output voltage adjustment, which allows output voltage adjustment from 60% to 110% (80% to 110% for the JC030A-M) of the nominal output voltage. For disk-drive applications, the JC030B-M Power Module provides a motor-start surge current of 3 A.

The modules are PC-board mountable and encapsulated in metal cases. The modules are rated to full load at 100 °C case temperature with no external filtering.

*UL is a registered trademark of Underwriters Laboratories, Inc.
†CSA is a registered trademark of the Canadian Standards Association.

Absolute Maximum Ratings

Stresses in excess of the absolute maximum ratings can cause permanent damage to the device. These are absolute stress ratings only. Functional operation of the device is not implied at these or any other conditions in excess of those given in the operations sections of the data sheet. Exposure to absolute maximum ratings for extended periods can adversely affect device reliability.

Parameter	Symbol	Min	Max	Unit
Input Voltage Continuous	V_I	—	50	V
I/O Isolation Voltage:				
dc	—	—	500	V
Transient (1 min)	—	—	850	V
Operating Case Temperature	T_c	-40	100	°C
Storage Temperature	T_{stg}	-40	110	°C

Electrical Specifications

Unless otherwise indicated, specifications apply over all operating input voltage, resistive load, and temperature conditions.

Table 1. Input Specifications

Parameter	Symbol	Min	Typ	Max	Unit
Operating Input Voltage	V_I	18	24	36	Vdc
Maximum Input Current ($V_I = 0$ V to 6 V; $I_O = I_{O, max}$. See Figure 1.)	$I_{I, max}$	—	—	3.0	A
Inrush Transient	i^2t	—	—	0.2	A ² s
Input Reflected-ripple Current, Peak-to-peak (5 Hz to 20 MHz, 12 μ H source impedance; $T_c = 25$ °C; see Figure 14 and Design Considerations section.)	—	—	30	—	mAp-p
Input Ripple Rejection (120 Hz)	—	—	60	—	dB

Fusing Considerations

CAUTION: This power module is not internally fused. An input line fuse must always be used.

This encapsulated power module can be used in a wide variety of applications, ranging from simple stand-alone operation to an integrated part of a sophisticated power architecture. To preserve maximum flexibility, internal fusing is not included; however, to achieve maximum safety and system protection, always use an input line fuse with a dc rating of no greater than 5 A (see Safety Considerations section). Based on the information provided in this data sheet on inrush energy and maximum dc input current, the same type of fuse with a lower rating can be used. Refer to the fuse manufacturer's data for further information.



Electrical Specifications (continued)

Table 2. Output Specifications

Parameter	Device	Symbol	Min	Typ	Max	Unit
Output Voltage (Over all operating input voltage, resistive load, and temperature conditions until end of life. See Figure 15.)	JC030A-M	V_o	4.85	—	5.15	Vdc
	JC030B-M	V_o	11.64	—	12.36	Vdc
	JC030C-M	V_o	14.55	—	15.45	Vdc
Output Voltage Set Point ($V_i = 24$ V; $I_o = I_{o, \max}$; $T_c = 25$ °C)	JC030A-M	$V_{o, \text{set}}$	4.95	5.0	5.05	Vdc
	JC030B-M	$V_{o, \text{set}}$	11.82	12.0	12.18	Vdc
	JC030C-M	$V_{o, \text{set}}$	14.77	15.0	15.23	Vdc
Output Regulation: Line ($V_i = 18$ V to 36 V) Load ($I_o = I_{o, \min}$ to $I_{o, \max}$) Temperature (See Figures 2—4.) ($T_c = -40$ °C to +100 °C)	All	—	—	0.01	0.1	%
	All	—	—	0.05	0.2	%
	JC030A-M, B-M, C-M	—	—	0.5	1.5	%
Output Ripple and Noise: RMS Peak-to-peak (5 Hz to 20 MHz)	JC030A-M	—	—	—	20	mVrms
	JC030B-M, C-M	—	—	—	25	mVrms
	JC030A-M	—	—	—	150	mVp-p
	JC030B-M, C-M	—	—	—	200	mVp-p
Output Current (At $I_o < I_{o, \min}$, the modules may exceed output ripple specifications.)	JC030A-M	I_o	0.6	—	6.0	A
	JC030B-M	I_o	0.3	—	2.5	A
	JC030B-M	$I_{o, \text{trans}}$	—	—	3.0	A
	JC030C-M	I_o	0.2	—	2.0	A
Output Current-limit Inception ($V_o = 90\%$ of $V_{o, \text{nom}}$; see Figures 5—7.)	JC030A-M	—	—	6.9	—	A
	JC030B-M	—	—	3.6	—	A
	JC030C-M	—	—	2.5	—	A
Output Short-circuit Current ($V_o = 250$ mV)	JC030A-M	—	—	8.0	9.5	A
	JC030B-M	—	—	4.0	5.5	A
	JC030C-M	—	—	3.0	4.5	A
Efficiency ($V_i = 24$ V; $I_o = I_{o, \max}$; $T_c = 25$ °C; (See Figures 8—10 and 15.)	JC030A-M	η	78	80	—	%
	JC030B-M, C-M	η	78	83	—	%
Dynamic Response ($\Delta I_o / \Delta t = 1$ A/10 μ s, $V_i = 24$ V, $T_c = 25$ °C; see Figures 11 and 12.) Load Change from $I_o = 50\%$ to 75% of $I_{o, \max}$: Peak Deviation Settling Time ($V_o < 10\%$ peak deviation) Load Change from $I_o = 50\%$ to 25% of $I_{o, \max}$: Peak Deviation Settling Time ($V_o < 10\%$ of peak deviation)	all	—	—	2	—	% $V_{o, \text{set}}$
	all	—	—	0.5	—	ms
	all	—	—	2	—	% $V_{o, \text{set}}$
	all	—	—	0.5	—	ms

Electrical Specifications (continued)

Table 3. Isolation Specifications

Parameter	Min	Typ	Max	Unit
Isolation Capacitance	—	0.02	—	μF
Isolation Resistance	10	—	—	MΩ

General Specifications

Parameter	Min	Typ	Max	Unit
Calculated MTBF ($I_o = 80\%$ of $I_{o, max}$; $T_c = 40\text{ }^\circ\text{C}$)	4,310,000			hours
Weight	—	—	3.5 (100)	oz. (g)

Feature Specifications

Unless otherwise indicated, specifications apply over all operating input voltage, resistive load, and temperature conditions. See Feature Descriptions and Design Considerations for further information.

Parameter	Device	Symbol	Min	Typ	Max	Unit
Remote On/Off ($V_i = 0\text{ V}$ to 36 V ; open collector or equivalent compatible; signal referenced to $V_i(-)$ terminal. See Figure 16 and Feature Descriptions.): JC030X-M Logic Low—Module Off Logic High—Module On JC030X1-M Negative Logic Logic Low—Module On Logic High—Module Off Module Specifications: On/Off Current—Logic Low On/Off Voltage: Logic Low Logic High ($I_{on/off} = 0$) Open Collector Switch Specifications: Leakage Current During Logic High ($V_{on/off} = 10\text{ V}$) Output Low Voltage During Logic Low ($I_{on/off} = 1\text{ mA}$) Turn-on Time (@ 80% of $I_{o, max}$; $T_A = 25\text{ }^\circ\text{C}$; V_o within $\pm 1\%$ of steady state) Output Voltage Overshoot (See Figure 13.)	All	$I_{on/off}$	—	—	1.0	mA
	All	$V_{on/off}$	0	—	1.2	V
	All	$V_{on/off}$	—	—	6	V
	All	$I_{on/off}$	—	—	50	μA
	All	$V_{on/off}$	—	—	1.2	V
	All	—	—	30	90	ms
	All	—	—	0	5	%
Output Voltage Sense Range	All	—	—	—	0.5	V
Output Voltage Set Point Adjustment Range (See Feature Descriptions.)	JC030A-M JC030B-M, C-M	—	80 60	—	110 110	% $V_{O, nom}$ % $V_{O, nom}$
Output Overvoltage Clamp	JC030A-M JC030B-M JC030C-M	$V_{O, clamp}$ $V_{O, clamp}$ $V_{O, clamp}$	5.6 13.0 17.0	— — —	7.0 16.0 20.0	V V V



Characteristic Curves

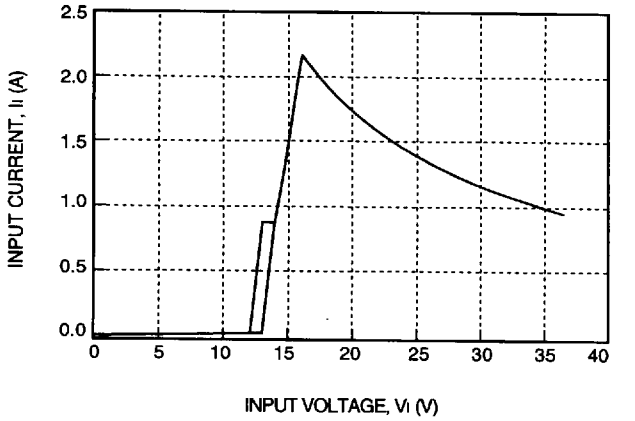

8-724(C)

Figure 1. JC030-Series Typical Input Characteristic

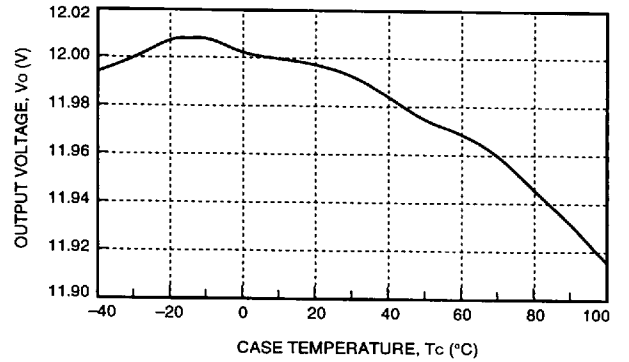

8-853(C)

Figure 3. JC030B-M Typical Output Voltage Variation Over Ambient Temperature Range

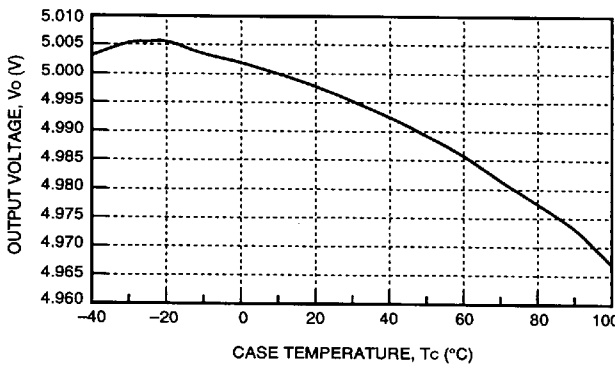

8-852(C)

Figure 2. JC030A-M Typical Output Voltage Variation Over Ambient Temperature Range

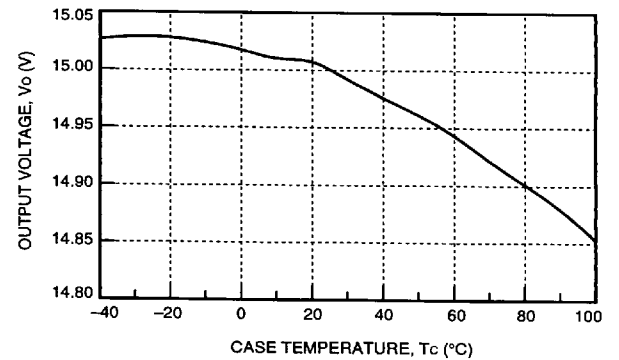

8-854(C)

Figure 4. JC030C-M Typical Output Voltage Variation Over Ambient Temperature Range



Characteristic Curves (continued)

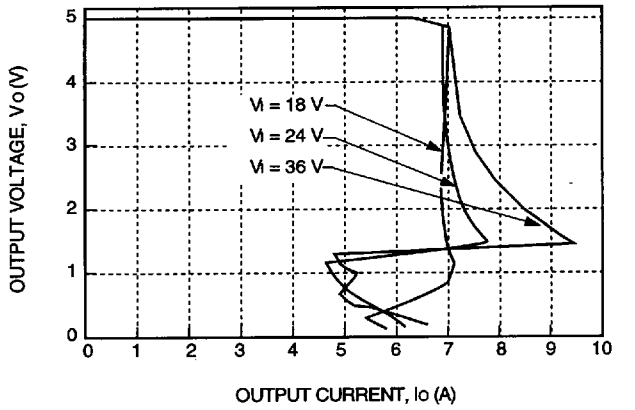

8-721(C)

Figure 5. JC030A-M Typical Output Characteristics

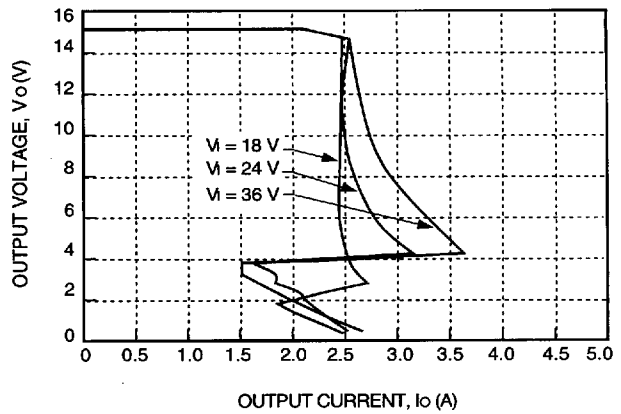

8-723(C)

Figure 7. JC030C-M Typical Output Characteristics

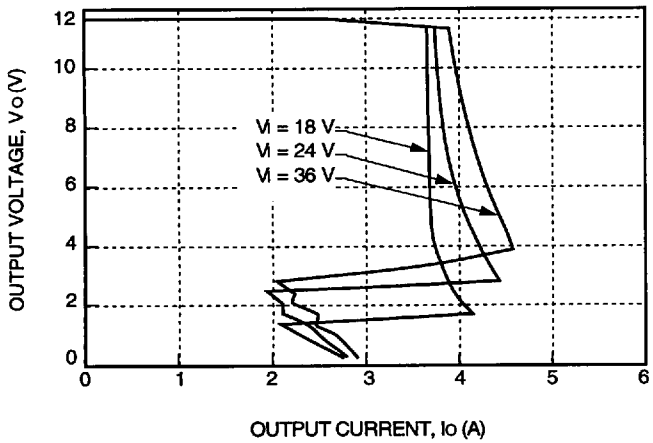

8-722(C)

Figure 6. JC030B-M Typical Output Characteristics

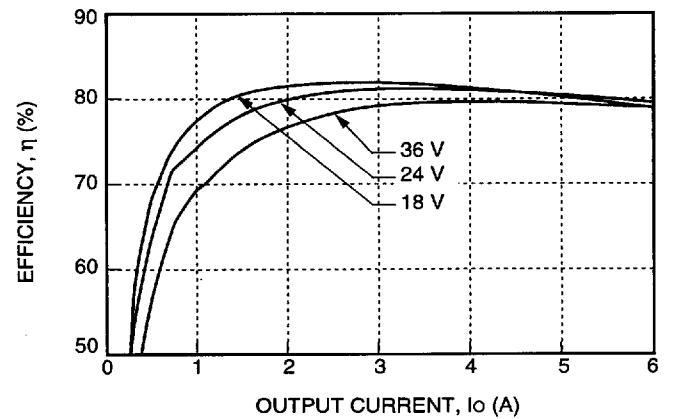

8-727(C)

Figure 8. JC030A-M Typical Converter Efficiency vs. Output Current



Characteristic Curves (continued)

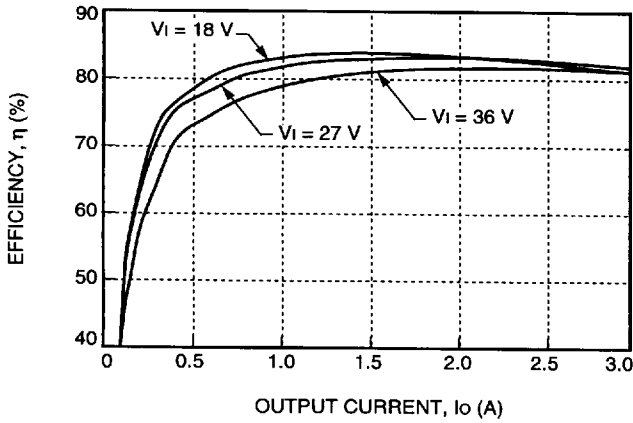

8-726(C)

Figure 9. JC030B-M Typical Converter Efficiency vs. Output Current

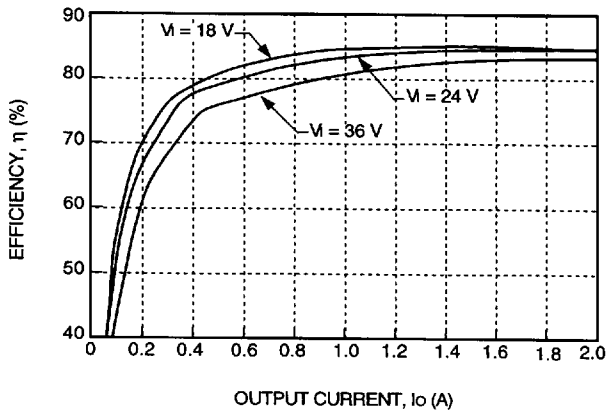

8-725(C)

Figure 10. JC030C-M Typical Converter Efficiency vs. Output Current

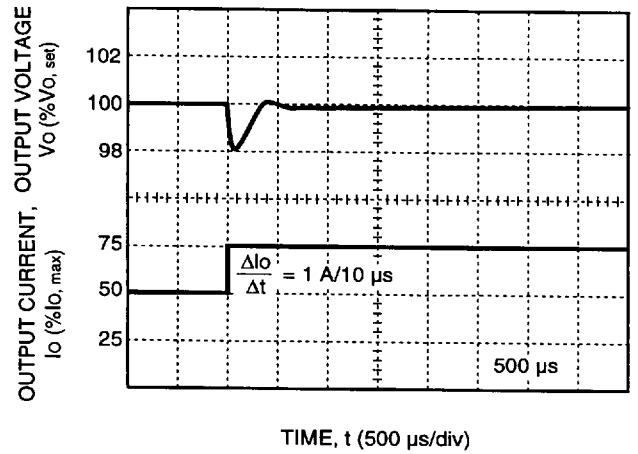

8-731(C)

Figure 11. Typical Output Voltage for a Step Load Change from 50% to 75%

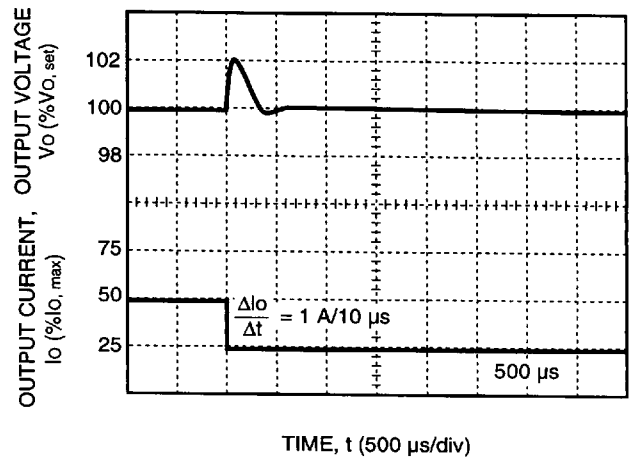

8-732(C)

Figure 12. Typical Output Voltage for a Step Load Change from 50% to 25%

Characteristic Curves (continued)

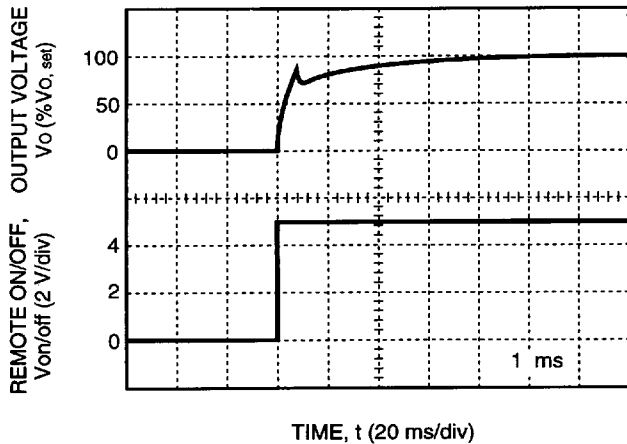

8-733(C)

Figure 13. Typical Output Voltage Start-Up when Signal Applied to Remote On/Off

Test Configurations

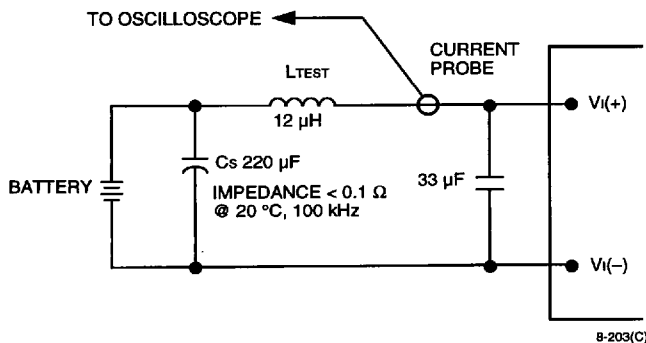

Note: Input reflected-ripple current is measured with a simulated source impedance of 12 μ H. Capacitor C_s offsets possible battery impedance. Current is measured at the input of the module.

Figure 14. Input Reflected-Ripple Test Setup

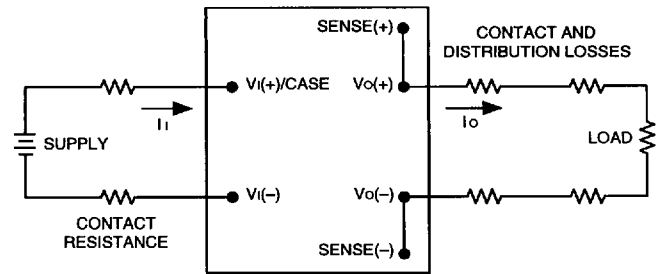

8-749(C).a

Note: All measurements are taken at the module terminals. When socketing, place Kelvin connections at module terminals to avoid measurement errors due to socket contact resistance.

$$\eta = \left(\frac{[V_o(+)-V_o(-)]I_o}{[V_i(+)-V_i(-)]I_i} \right) \times 100$$

Figure 15. Output Voltage and Efficiency Measurement Test Setup

Design Considerations

Input Source Impedance

The power module should be connected to a low ac-impedance input source. Highly inductive source impedances can affect the stability of the power module. A 33 μ F electrolytic capacitor (ESR < 0.7 Ω at 100 kHz) mounted close to the power module helps ensure stability of the unit.

Safety Considerations

For safety-agency approval of the system in which the power module is used, the power module must be installed in compliance with the spacing and separation requirements of the end-use safety agency standard, i.e., UL-1950, CSA 22.2-950, EN 60950.

For the converter output to be considered meeting the requirements of safety extra low voltage (SELV), one of the following must be true of the dc input:

- All inputs are SELV and floating, with the output also floating.
- All inputs are SELV and grounded, with the output also grounded.
- Any non-SELV input must be provided with reinforced insulation from any other hazardous voltages, including the ac mains, and must have an SELV reliability test performed on it in combination with the converters.

The power module has extra low voltage (ELV) outputs when all inputs are ELV.

Feature Descriptions

Remote On/Off

Two remote on/off options are available. Positive logic remote on/off turns the module on during a logic high voltage on the remote on/off pin, and off during a logic low. Negative logic remote on/off (suffix 1) turns the module off during a logic high and on during a logic low. Standard modules provide positive logic remote on/off.

To turn the power module on and off, the user must supply a switch to control the voltage between the on/off terminal and the $V_I(-)$ terminal ($V_{on/off}$). The switch can be an open collector or equivalent (see Figure 16). A logic low is $V_{on/off} = 0$ V to 1.2 V. The maximum $I_{on/off}$ during a logic low is 1 mA. The switch should maintain a logic low voltage while sinking 1 mA.

During a logic high, the maximum $V_{on/off}$ generated by the power module is 6 V. The maximum allowable leakage current of the switch at $V_{on/off} = 6$ V is 50 μ A.

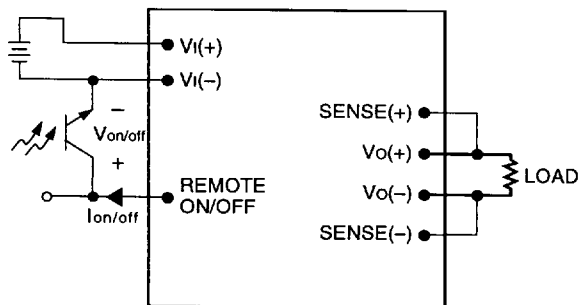

8-720(C).a

Figure 16. Remote On/Off Implementation

Output Overvoltage Clamp

The output overvoltage clamp consists of control circuitry, independent of the primary regulation loop, that monitors the voltage on the output terminals. The control loop of the clamp has a higher voltage set point than the primary loop (see Feature Specifications table). This provides a redundant voltage control that reduces the risk of output overvoltage.

Output voltage trim allows the user to increase or decrease the output voltage set point of a module. This is accomplished by connecting an external resistor between the TRIM pin and either the SENSE(+) or SENSE(-) pins. With an external resistor between the TRIM and SENSE(-) pins ($R_{adj-down}$), the output voltage

set point ($V_{o, adj}$) decreases (see Figure 17). The following equation determines the required external resistor value to obtain an output voltage change of $\% \Delta$.

$$R_{adj-down} = \left(\frac{1 - \% \Delta}{\% \Delta} \right) 10 \text{ k}\Omega$$

For example, to lower the output voltage by 30%, the external resistor value must be:

$$R_{adj-down} = \left(\frac{1 - 0.3}{0.3} \right) 10 \text{ k}\Omega = 23.33 \text{ k}\Omega$$

With an external resistor connected between the TRIM and SENSE(+) pins (R_{adj-up}), the output voltage set point ($V_{o, adj}$) increases (see Figure 18). The following equation determines the required external resistor value to obtain an output voltage change of $\% \Delta$.

$$R_{adj-up} = \left(\frac{V_{O,nom}}{2.5} - 1 \right) \left(\frac{1 + \% \Delta}{\% \Delta} \right) 10 \text{ k}\Omega$$

For example, to increase the output voltage of the JC030B by 5%, the external resistor value must be:

$$R_{adj-up} = \left(\frac{12.0}{2.5} - 1 \right) \left(\frac{1 + 0.05}{0.05} \right) 10 \text{ k}\Omega = 798 \text{ k}\Omega$$

The combination of the output voltage adjustment and sense range and the output voltage given in the Feature Specifications table cannot exceed 110% of the nominal output voltage between the $V_O(+)$ and $V_O(-)$ terminals.

The JC030 Power Module family has a fixed current-limit set point. Therefore, as the output voltage is adjusted down, the available output power is reduced. In addition, the minimum output current is a function of the output voltage. As the output voltage is adjusted down, the minimum required output current can increase.

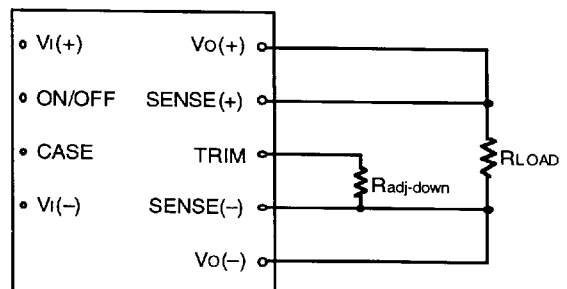

8-748(C).b

Figure 17. Circuit Configuration to Decrease Output Voltage

Feature Descriptions (continued)

Output Overvoltage Clamp (continued)

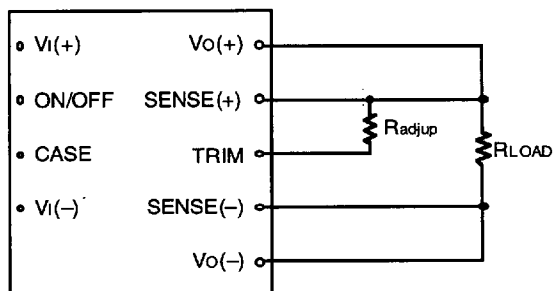

8-715(C).b

Figure 18. Circuit Configuration to Increase Output Voltage

Current Limit

To provide protection in a fault (output overload) condition, the unit is equipped with internal current-limiting circuitry and can endure current limiting for an unlimited duration. At the point of current-limit inception, the unit shifts from voltage control to current control. If the output voltage is pulled very low during a severe fault, the current-limit circuit can exhibit either foldback or tailout characteristics (output current decrease or increase). The unit operates normally once the output current is brought back into its specified range.



Thermal Considerations

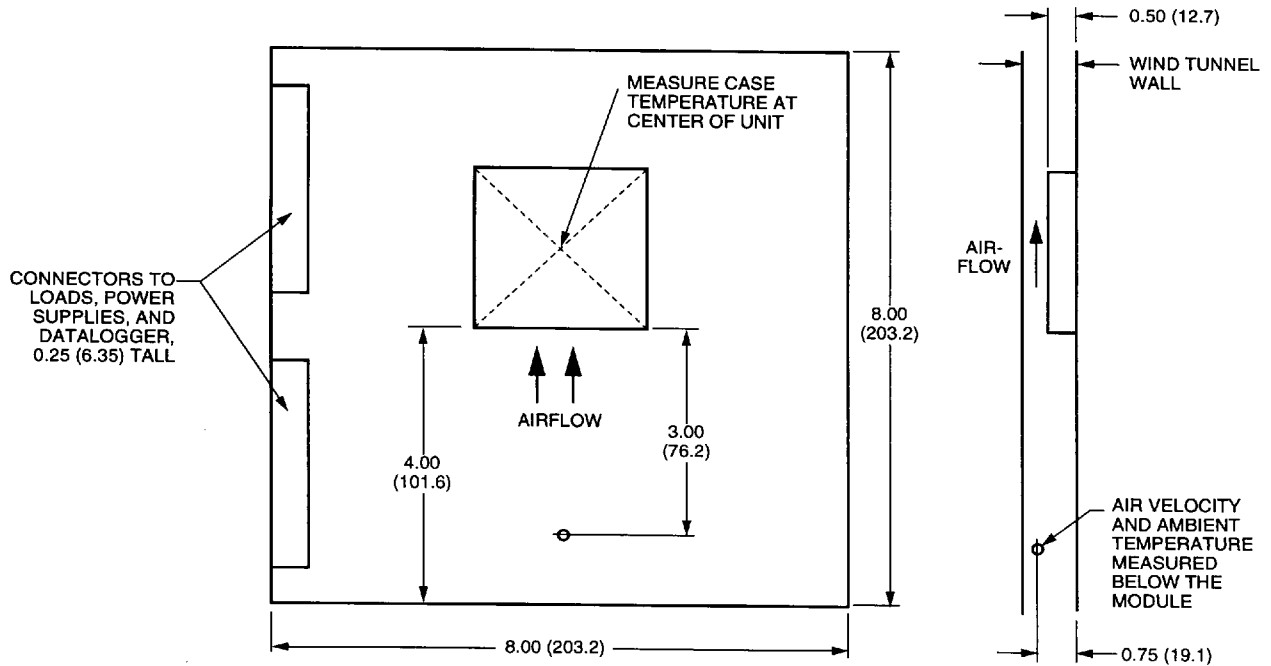

8-1046(C)

Figure 19. Thermal Test Setup



Thermal Considerations (continued)

The JC030-Series Power Modules are designed to operate in a variety of thermal environments. As with any electronic component, sufficient cooling must be provided to help ensure reliable operation. Heat-dissipating components inside the module are thermally coupled to the case to enable heat removal by conduction, convection, and radiation to the surrounding environment.

The thermal data presented is based on measurements taken in a wind tunnel. The test setup shown in Figure 19 was used to collect data for Figures 23 and 24.

The graphs in Figures 20 through 24 provide general guidelines for use. Actual performance can vary depending on the particular application environment. The maximum case temperature of 100 °C must not be exceeded.

Basic Thermal Performance

The JC030-Series power module is built with a specially designed, heat spreading enclosure. As a result, full-load operation in natural convection at 50 °C can be achieved without the use of an external heat sink.

Higher ambient temperatures can be sustained by increasing the airflow or by adding a heat sink. As stated, this data is based on a maximum case temperature of 100 °C and measured in the test configuration shown in Figure 19.

Forced Convection Cooling

To determine the necessary airflow, determine the power dissipated by the unit for the particular application. Figures 20 through 22 show typical power dissipation for those power modules over a range of output currents. With the known power dissipation and a given local ambient temperature, the appropriate airflow can be chosen from the derating curves in Figure 23. For example, if the unit dissipates 6.2 W, the minimum airflow in an 80 °C environment is 200 ft./min. (1.02 m/s).

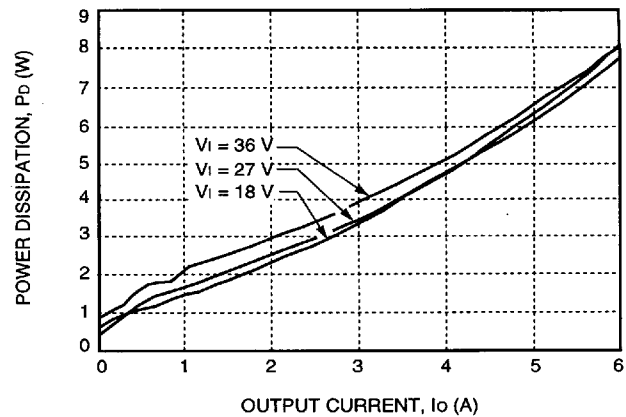

8-1154(C)

Figure 20. JC030A-M Power Dissipation vs. Output Current

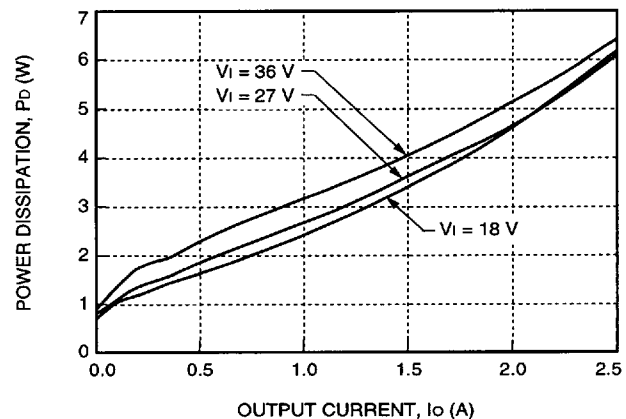

8-1211(C)

Figure 21. JC030B-M Power Dissipation vs. Output Current



Thermal Considerations (continued)

Forced Convection Cooling (continued)

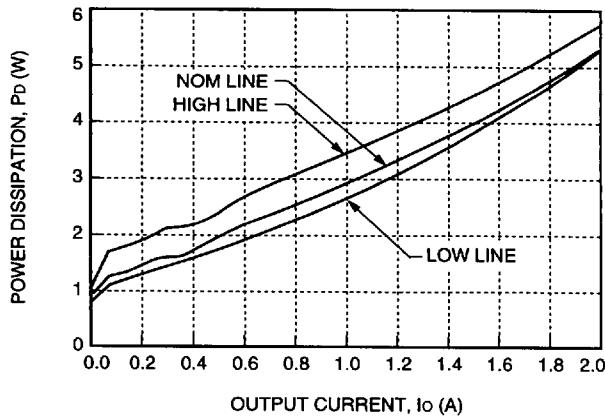

8-1212(C)

Figure 22. JC030C-M Power Dissipation vs. Output Current

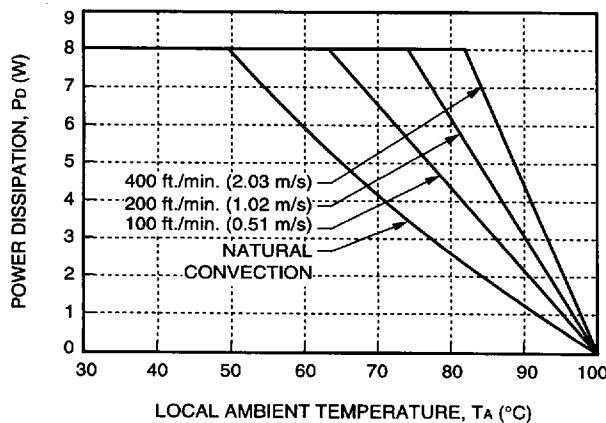

8-1051(C).a

Figure 23. Forced Convection Power Derating with No Heat Sink; Either Orientation

Heat Sink Selection

Several heat sinks are available for these modules. The case includes through threaded mounting holes allowing attachment of heat sinks or cold plates from either side of the module. The mounting torque must not exceed 5 in.-lb. (0.56 N-m).

Figure 24 shows the case-to-ambient thermal resistance, θ ($^{\circ}\text{C}/\text{W}$), for these modules. These curves can be used to predict which heat sink will be needed for a particular environment. For example, if the unit dissipates 7 W of heat in an 80 $^{\circ}\text{C}$ environment with an air flow of 130 ft./min. (0.66 m/s), the minimum heat sink required can be determined as follows:

$$\theta \leq (T_{C, \max} - T_A) / P_D$$

where:

- θ = module's total thermal resistance
- $T_{C, \max}$ = case temperature (See Figure 19.)
- T_A = inlet ambient temperature (See Figure 19.)
- P_D = power dissipation

$$\theta \leq (100 - 80) / 7$$

$$\theta \leq 2.9 \text{ } ^{\circ}\text{C}/\text{W}$$

From Figure 24, the 1/2 in. high heat sink or greater is required.

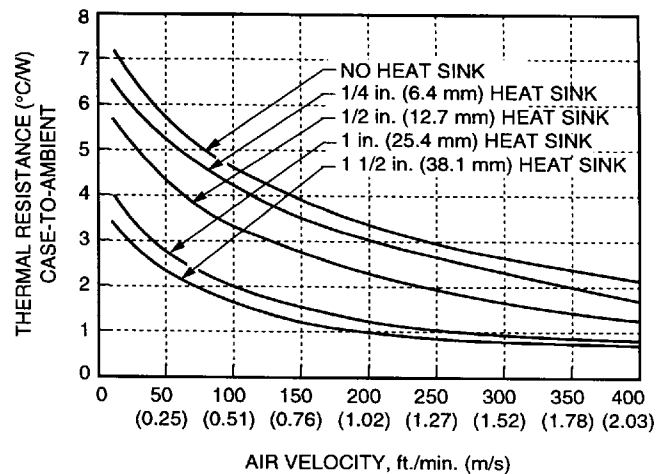

8-1052(C).a

Figure 24. Case-to-Ambient Thermal Resistance vs. Air Velocity Curves; Either Orientation

Although the previous example uses 100 $^{\circ}\text{C}$ as the maximum case temperature, for extremely high-reliability applications, one can use a lower temperature for $T_{C, \max}$.

Thermal Considerations (continued)

Heat Sink Selection (continued)

The thermal resistances shown in Figure 24 are for heat transfer from the sides and bottom of the module as well as the top side with the attached heat sink; therefore, the case-to-ambient thermal resistances shown will generally be lower than the resistance of the heat sink by itself. The data in Figure 24 was taken with a thermally conductive dry pad between the case and the heat sink to minimize contact resistance (typically 0.1 °C/W to 0.3 °C/W).

For a more detailed explanation of thermal energy management for this series of power modules as well as more details on available heat sinks, please request the following technical note: *Thermal Energy Management for JC- and JW-Series 30 Watt Board-Mounted Power Modules*.



Outline Diagram

Dimensions are in inches and (millimeters).

Copper paths must not be routed beneath the power module standoffs.

Tolerances: $x.xx \pm 0.02$ in. (0.5 mm), $x.xxx \pm 0.010$ in. (0.25 mm).

Top View

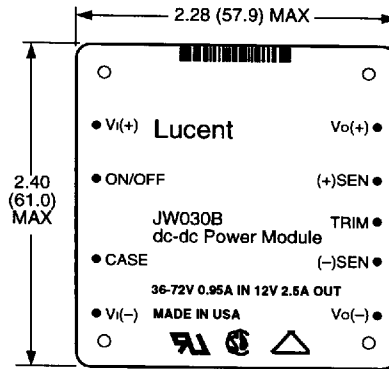

8-716(C)

Side View

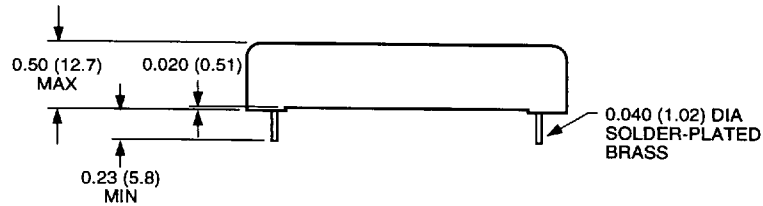

8-716(C)

Bottom View

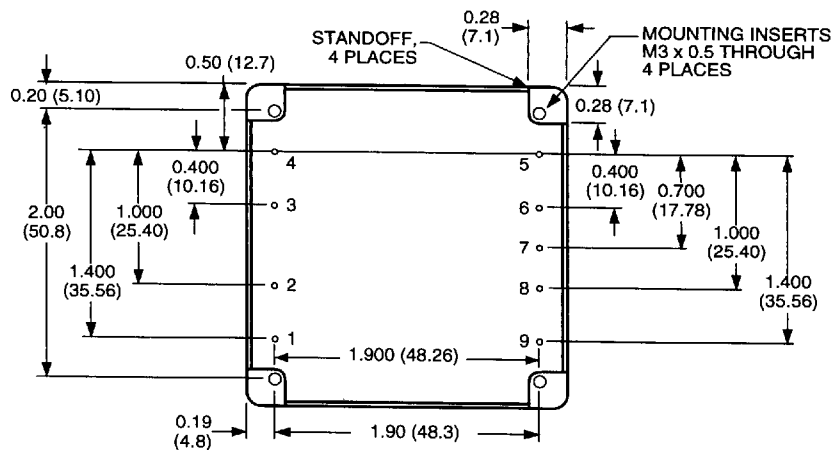

8-716(C)

Recommended Hole Pattern

Component-side footprint.

Dimensions are in inches and (millimeters).

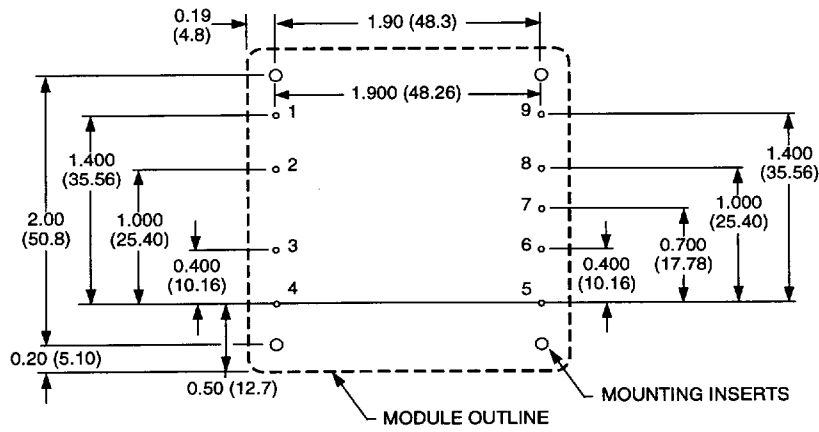

8-716(C)



Ordering Information

Input Voltage	Output Voltage	Output Power	Device Code	Comcode
24 V	5 V	30 W	JC030A-M	107587719
24 V	12 V	30 W	JC030B-M	107587735
24 V	15 V	30 W	JC030C-M	107587768

Optional features may be ordered using the device code suffixes shown below. To order more than one option, list suffixes in numerically descending order followed by the -M suffix indicating metric (M3x0.5) heat sink hardware. The heat sinks designed for this package have an M prefix, i.e., MHSTxxx40, see *Thermal Energy Management CC-, CW-, DC-, and DW-Series 25 W to 30 W Board-Mounted Power Modules*.

Option	Device Code Suffix
Short pin (0.110 in. ± 0.010 in.)	8
Negative on/off logic	1

Please contact your Microelectronics Group Account Manager or Application Engineer for pricing and availability of options.

