

Dual/Quad 130MHz Current Feedback Amplifiers

élantec

The EL2260/EL2460 are dual/quad current feedback operational amplifiers with -3dB bandwidth of 130MHz at a gain of +2. Built using the Elantec proprietary monolithic complementary bipolar process, these amplifiers use current mode feedback to achieve more bandwidth at a given gain than a conventional voltage feedback operational amplifier.

The EL2260/EL2460 are designed to drive a double terminated 75Ω coax cable to video levels. Differential gain and phase are excellent when driving both loads of 500Ω ($< 0.01\%/< 0.01^\circ$) and double terminated 75Ω cables (0.025%/0.1°).

The amplifiers can operate on any supply voltage from 4V ($\pm 2V$) to 33V ($\pm 16.5V$), yet consume only 7.5mA per amplifier at any supply voltage. Using industry standard pinouts, the EL2260 is available in 8-pin PDIP and 8-pin SO packages, while the EL2460 is available in 14-pin PDIP and 14-pin SO packages.

Elantec's facilities comply with MIL-I-45208A and offer applicable quality specifications. For information on Elantec's processing, see the Elantec document, QRA-1: Elantec's Processing—Monolithic Products.

Pinouts

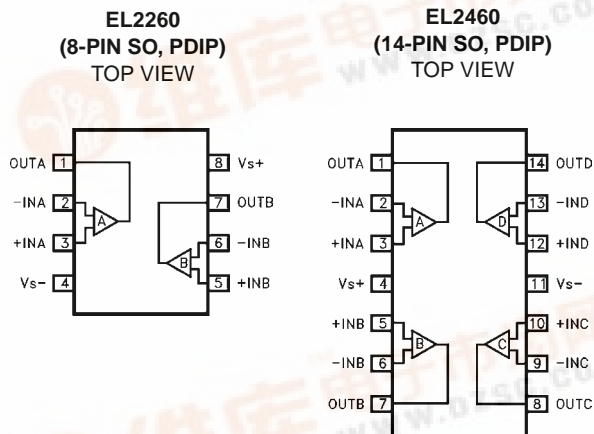

Features

- 130MHz 3dB bandwidth ($A_V = +2$)
- 180MHz 3dB bandwidth ($A_V = +1$)
- 0.01% differential gain, $R_L = 500\Omega$
- 0.01° differential phase, $R_L = 500\Omega$
- Low supply current, 7.5mA per amplifier
- Wide supply range, $\pm 2V$ to $\pm 15V$
- 80mA output current (peak)
- Low cost
- 1500V/ μs slew rate
- Input common mode range to within 1.5V of supplies
- 35ns settling time to 0.1%

Applications

- Video amplifiers
- Cable drivers
- RGB amplifiers
- Test equipment amplifiers
- Current to voltage converter

Ordering Information

PART NUMBER	TEMP. RANGE	PACKAGE	PKG. NO.
EL2260CN	-40°C to +85°C	8-Pin PDIP	MDP0031
EL2260CS	-40°C to +85°C	8-Pin SOIC	MDP0027
EL2460CN	-40°C to +85°C	14-Pin PDIP	MDP0031
EL2460CS	-40°C to +85°C	14-Pin SOIC	MDP0027

EL2260, EL2460

Absolute Maximum Ratings ($T_A = 25^\circ\text{C}$)

Voltage between V_{S+} and V_{S-}	+33V
Voltage between +IN and -IN	$\pm 6\text{V}$
Current into +IN or -IN	10mA
Internal Power Dissipation	See Curves
Operating Ambient Temperature Range	-40°C to $+85^\circ\text{C}$

Operating Junction Temperature	
Plastic Packages	150°C
Storage Temperature Range	-65°C to $+150^\circ\text{C}$
Output Current	$\pm 50\text{mA}$

CAUTION: Stresses above those listed in "Absolute Maximum Ratings" may cause permanent damage to the device. This is a stress only rating and operation of the device at these or any other conditions above those indicated in the operational sections of this specification is not implied.

IMPORTANT NOTE: All parameters having Min/Max specifications are guaranteed. Typical values are for information purposes only. Unless otherwise noted, all tests are at the specified temperature and are pulsed tests, therefore: $T_J = T_C = T_A$

Open-Loop DC Electrical Specifications

$V_S = \pm 15\text{V}$, $R_L = 150\Omega$, $T_A = 25^\circ\text{C}$ unless otherwise specified.

PARAMETER	DESCRIPTION	CONDITIONS	TEMP	LIMITS			UNITS
				MIN	TYP	MAX	
V_{OS}	Input Offset Voltage	$V_S = \pm 5\text{V}$, $\pm 15\text{V}$	25°C		2	10	mV
			T_{MIN} , T_{MAX}			15	mV
$TC V_{OS}$	Average Offset Voltage Drift (Note 1)		Full		10		$\mu\text{V}/^\circ\text{C}$
$+I_{IN}$	+Input Current	$V_S = \pm 5\text{V}$, $\pm 15\text{V}$	25°C		0.5	5	μA
			T_{MIN} , T_{MAX}			10	μA
$-I_{IN}$	-Input Current	$V_S = \pm 5\text{V}$, $\pm 15\text{V}$	25°C		5	25	μA
			T_{MIN} , T_{MAX}			35	μA
CMRR	Common Mode Rejection Ratio (Note 2)	$V_S = \pm 5\text{V}$, $\pm 15\text{V}$	Full	50	55		dB
-ICMR	-Input Current Common Mode Rejection (Note 2)	$V_S = \pm 5\text{V}$, $\pm 15\text{V}$	25°C		0.2	5	$\mu\text{A}/\text{V}$
			T_{MIN} , T_{MAX}			5	$\mu\text{A}/\text{V}$
PSRR	Power Supply Rejection Ratio (Note 3)		Full	75	95		dB
-IPSR	-Input Current Power Supply Rejection (Note 3)		25°C		0.2	5	$\mu\text{A}/\text{V}$
			T_{MIN} , T_{MAX}			5	$\mu\text{A}/\text{V}$
R_{OL}	Transimpedance (Note 4)	$V_S = \pm 15\text{V}$ $R_L = 400\Omega$	25°C	500	2000		$\text{k}\Omega$
			T_{MIN} , T_{MAX}	250			$\text{k}\Omega$
		$V_S = \pm 5\text{V}$ $R_L = 150\Omega$	25°C	500	1800		$\text{k}\Omega$
			T_{MIN} , T_{MAX}	250			$\text{k}\Omega$
$+R_{IN}$	+Input Resistance		Full	1.5	3.0		$\text{M}\Omega$
$+C_{IN}$	+Input Capacitance		25°C		2.5		pF
CMIR	Common Mode Input Range	$V_S = \pm 15\text{V}$	25°C		± 13.5		V
		$V_S = \pm 5\text{V}$	25°C		± 3.5		V
V_O	Output Voltage Swing	$R_L = 400\Omega$, $V_S = \pm 15\text{V}$	25°C	± 12	± 13.5		V
			T_{MIN} , T_{MAX}	± 11			V
		$R_L = 150\Omega$, $V_S = \pm 15\text{V}$	25°C		± 12		V
			T_{MIN} , T_{MAX}				
		$R_L = 150\Omega$, $V_S = \pm 5\text{V}$	25°C	± 3.0	± 3.7		V
			T_{MIN} , T_{MAX}	± 2.5			V
I_{SC}	Output Short Circuit Current (Note 5)	$V_S = \pm 5\text{V}$, $V_S = \pm 15\text{V}$	25°C	60	100	150	mA



EL2260, EL2460

Open-Loop DC Electrical Specifications

$V_S = \pm 15V$, $R_L = 150\Omega$, $T_A = 25^\circ C$ unless otherwise specified. (Continued)

PARAMETER	DESCRIPTION	CONDITIONS	TEMP	LIMITS			UNITS
				MIN	TYP	MAX	
I _S	Supply Current (Per Amplifier)	$V_S = \pm 15V$	25°C		7.5	11.0	mA
			T _{MIN} , T _{MAX}			11.0	mA
		$V_S = \pm 5V$	25°C		5.4	8.5	mA
			T _{MIN} , T _{MAX}			8.5	mA
R _{OL}	Transimpedance (Note 6)	$V_S = \pm 15V$ $R_L = 400\Omega$	25°C	500	2000		kΩ

NOTES:

1. Measured from T_{MIN} to T_{MAX}.
2. V_{CM} = ±10V for V_S = ±15V and T_A = Full
V_{CM} = ±3V for V_S = ±5V and T_A = 25°C
V_{CM} = ±2V for V_S = ±5V and T_A = T_{MIN}, T_{MAX}
3. The supplies are moved from ±2.5V to ±15V.
4. The supplies are moved from ±2.5V to ±15V.
5. A heat sink is required to keep junction temperature below absolute maximum when an output is shorted.
6. The supplies are moved from ±2.5V to ±15V.

Closed-Loop AC Electrical Specifications

$V_S = \pm 15V$, $A_V = +2$, $R_F = 560\Omega$, $R_L = 150\Omega$, $T_A = 25^\circ C$ unless otherwise noted

PARAMETER	DESCRIPTION	TEST CONDITIONS	LIMITS			UNITS
			MIN	TYP	MAX	
BW	-3dB Bandwidth (Note 1)	$V_S = \pm 15V$, $A_V = +2$		130		MHz
		$V_S = \pm 15V$, $A_V = +1$		180		MHz
		$V_S = \pm 5V$, $A_V = +2$		100		MHz
		$V_S = \pm 5V$, $A_V = +1$		110		MHz
SR	Slew Rate (Note 1) (Note 2)	$R_L = 400\Omega$	1000	1500		V/μs
		$R_F = 1k\Omega$, $R_G = 110\Omega$		1500		V/μs
		$R_L = 400\Omega$				
t _R , t _F	Rise Time, Fall Time (Note 1)	V _{OUT} = ±500mV		2.7		ns
t _{PD}	Propagation Delay (Note 1)			3.2		ns
OS	Overshoot (Note 1)	V _{OUT} = ±500mV		0		%
t _S	0.1% Settling Time (Note 1)	V _{OUT} = ±10V		35		ns
		$A_V = -1$, $R_L = 1k$				
dG	Differential Gain (Note 1)(Note 3)	$R_L = 150\Omega$		0.025		%
		$R_L = 500\Omega$		0.006		%
dP	Differential Phase (Note 1)(Note 3)	$R_L = 150\Omega$		0.1		deg (°)
		$R_L = 500\Omega$		0.005		deg (°)

NOTES:

1. All AC tests are performed on a "warmed up" part, except for Slew Rate, which is pulse tested.
2. Slew Rate is with V_{OUT} from +10V to -10V and measured at the 25% and 75% points.
3. DC offset from -0.714V through +0.714V, AC amplitude 286mV_{p-p}, f = 3.58MHz.



Typical Performance Curves

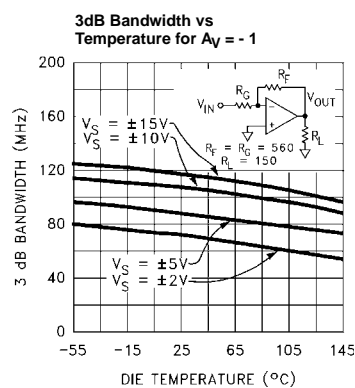
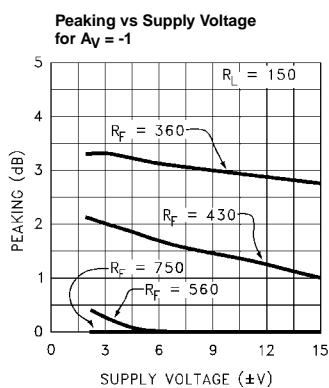
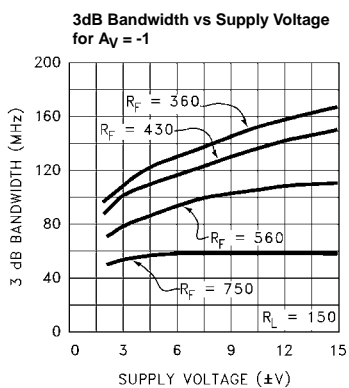
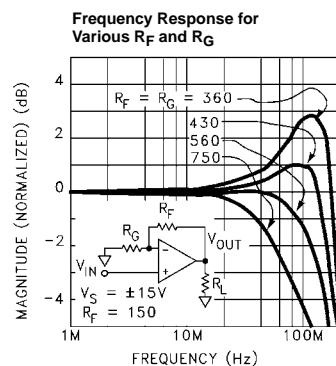
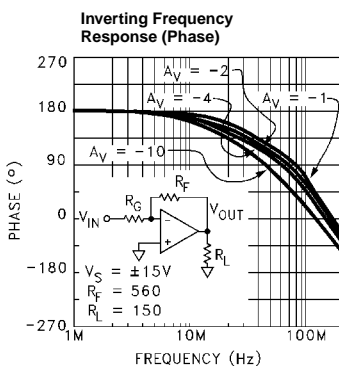
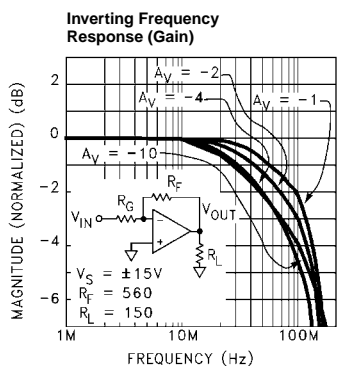
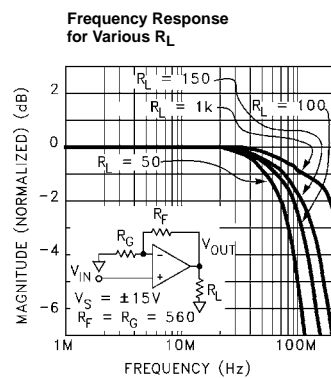
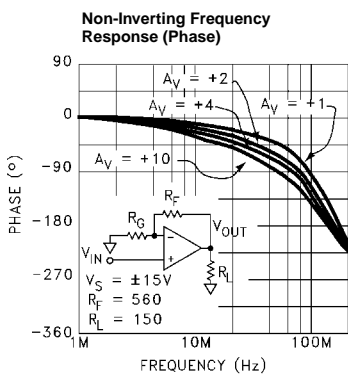
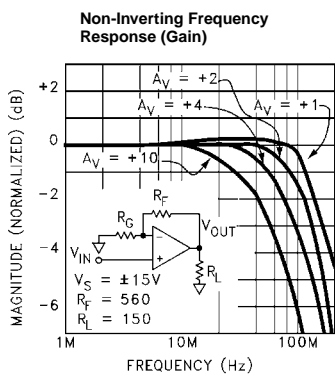

Typical Performance Curves (Continued)

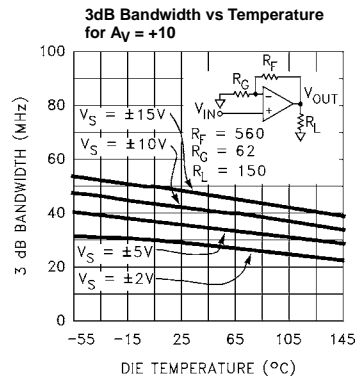
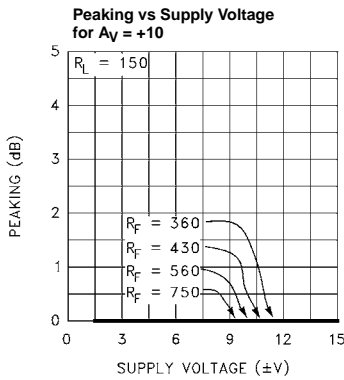
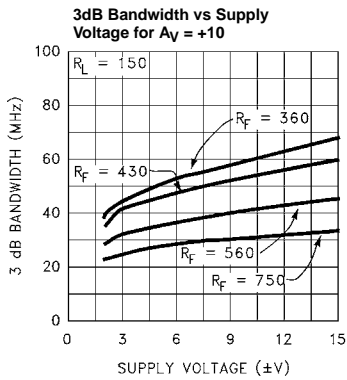
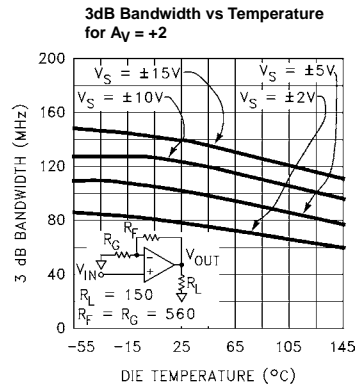
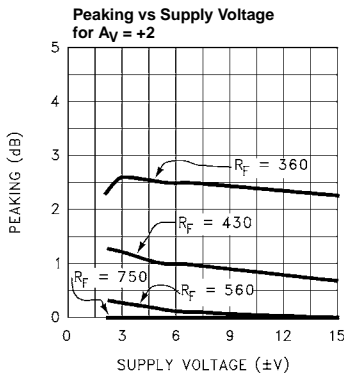
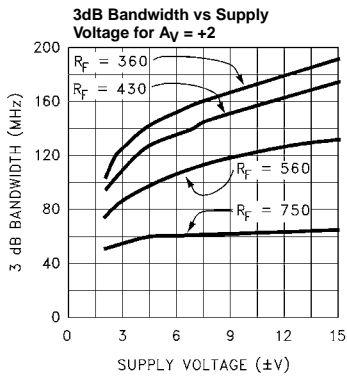
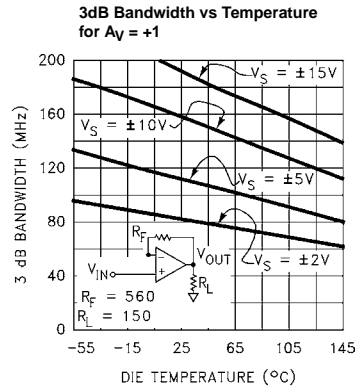
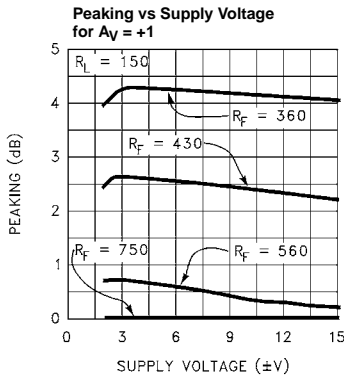
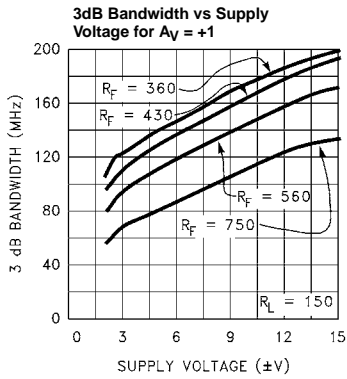

Typical Performance Curves (Continued)

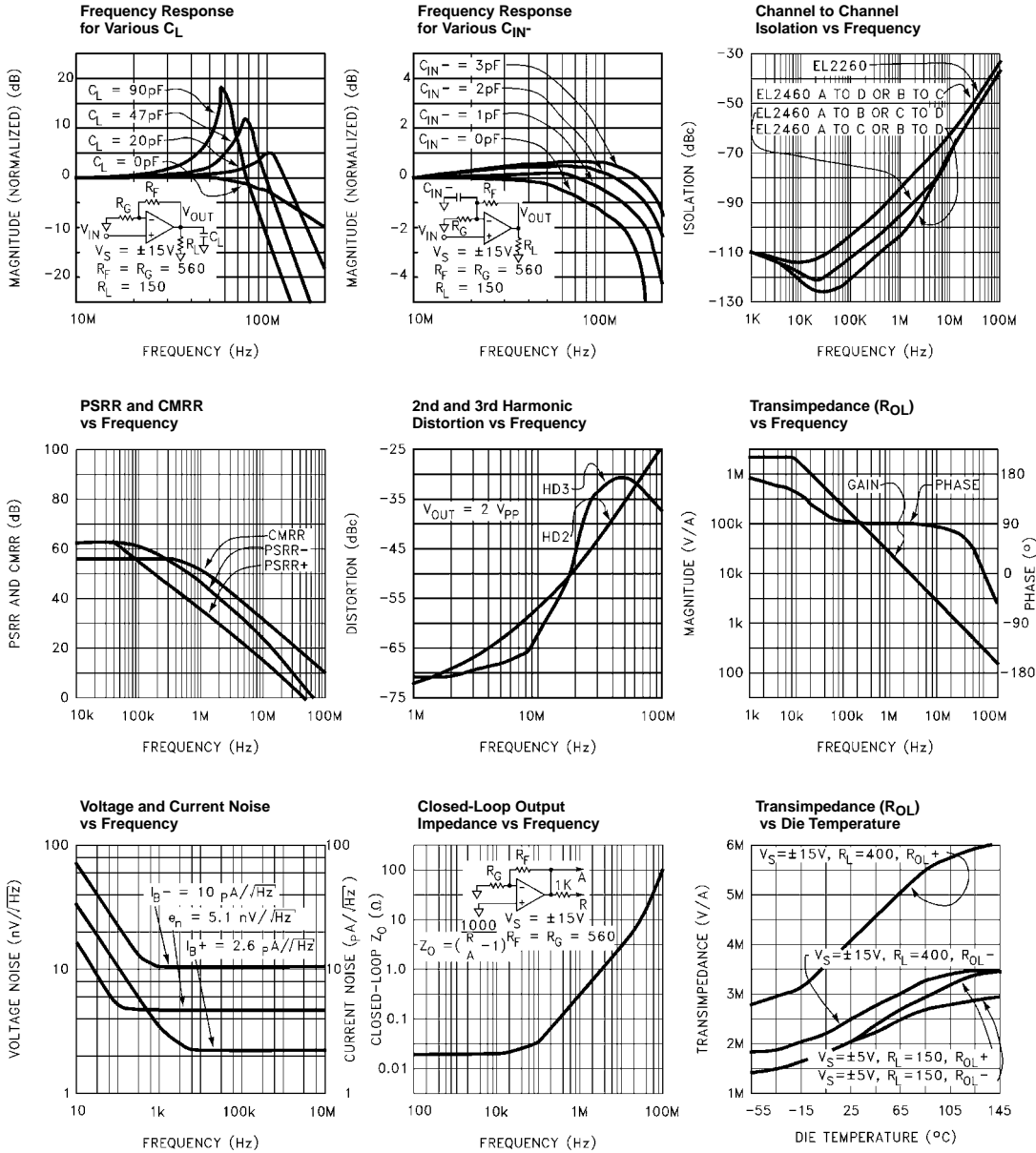

EL2260, EL2460

Typical Performance Curves (Continued)

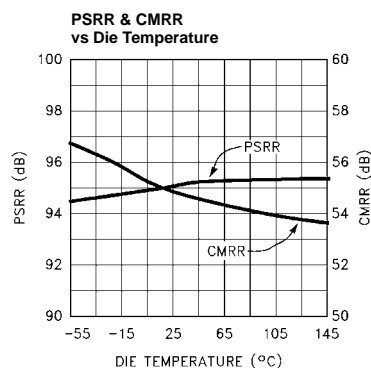
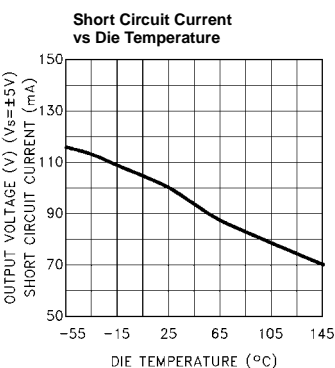
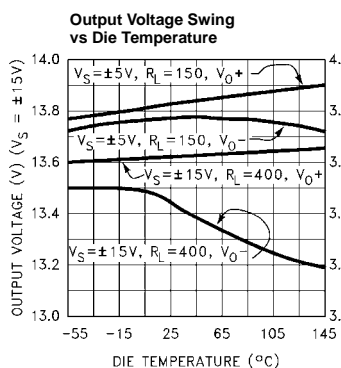
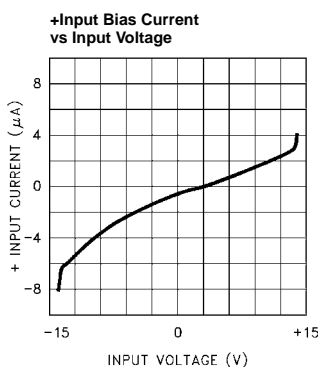
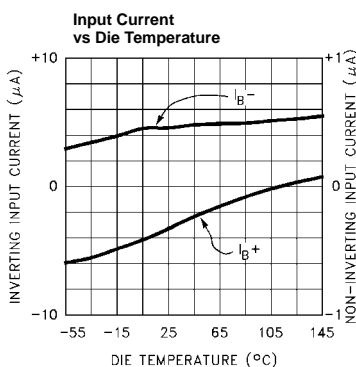
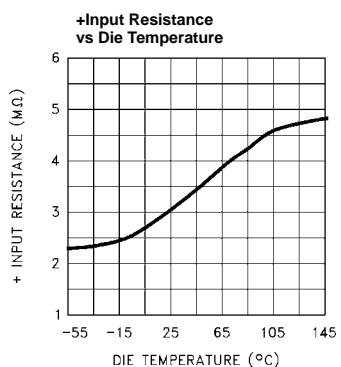
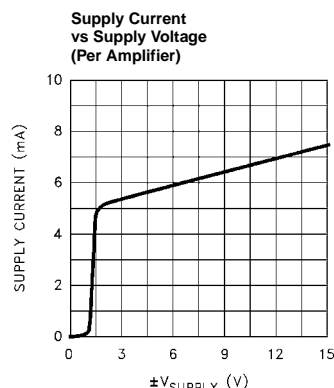
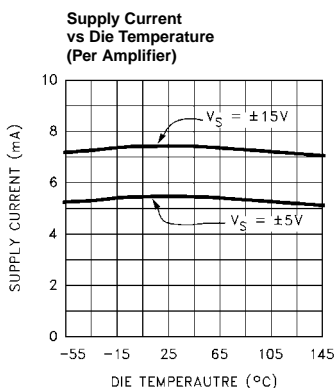
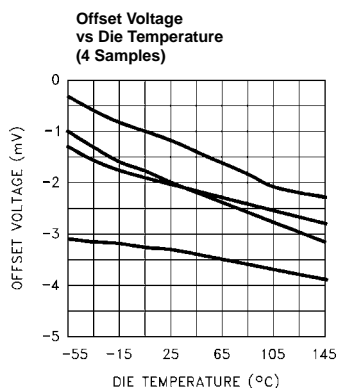

Typical Performance Curves (Continued)

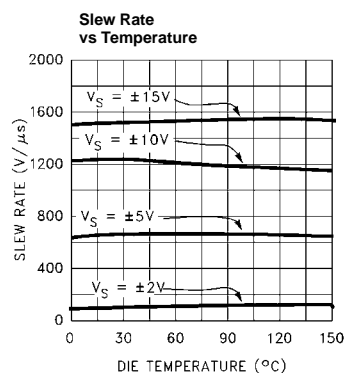
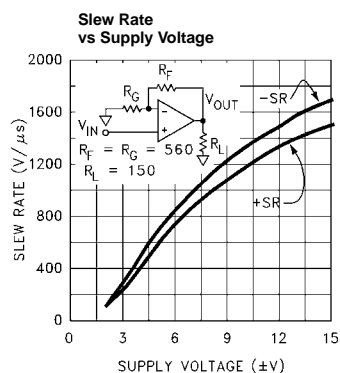
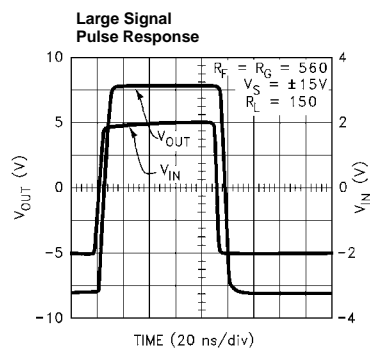
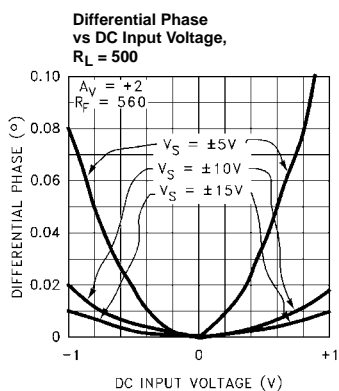
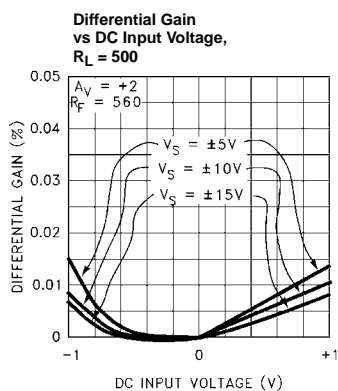
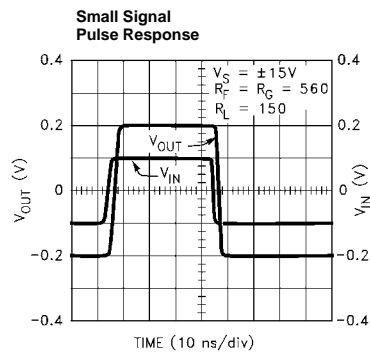
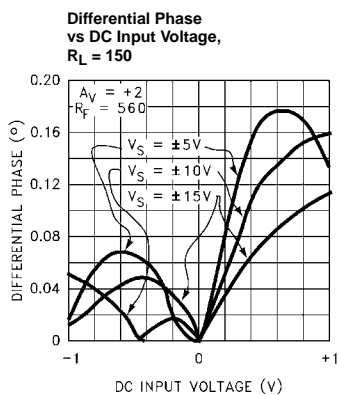
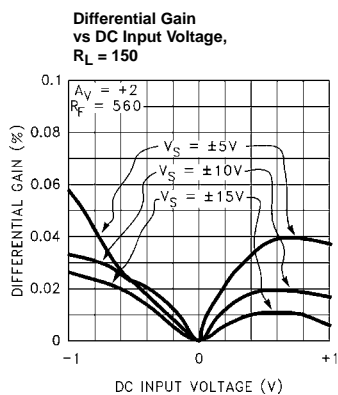

EL2260, EL2460

Typical Performance Curves (Continued)

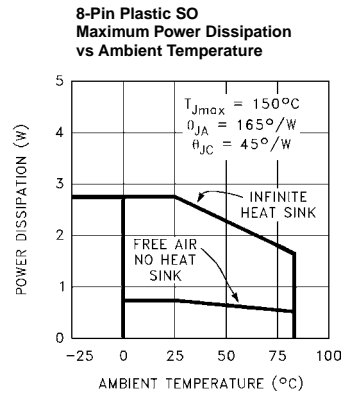
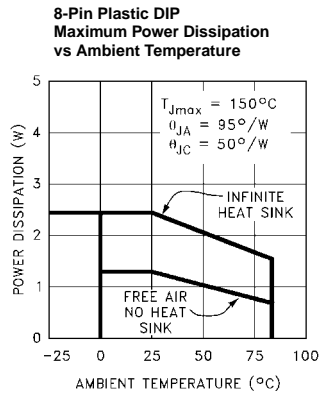
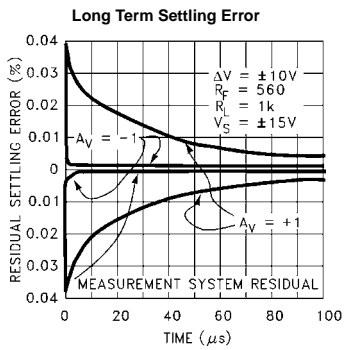
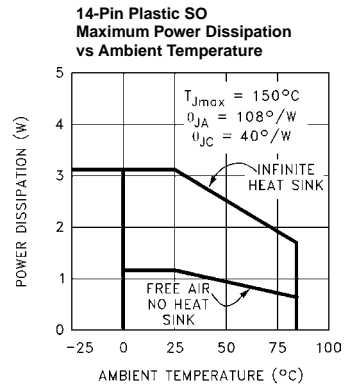
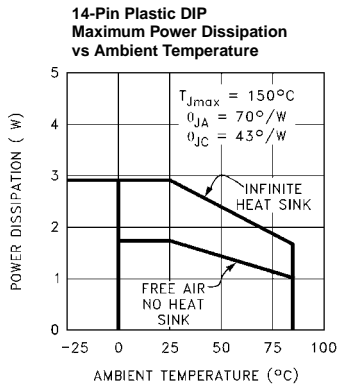
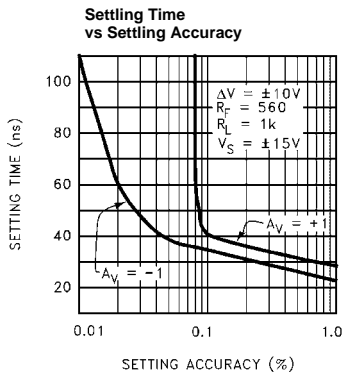

Burn-In Circuits

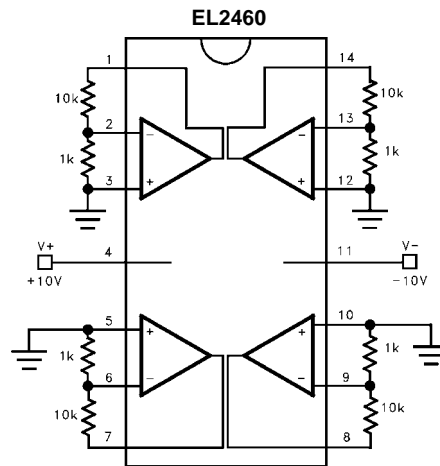
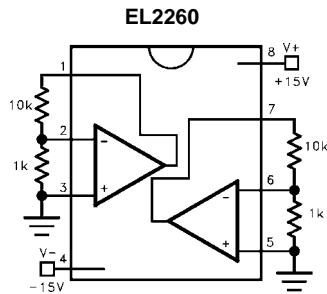

Differential Gain and Phase Test Circuit

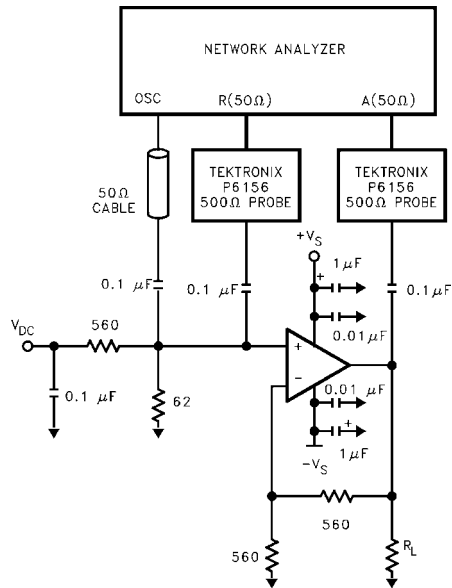

Simplified Schematic (One Amplifier)

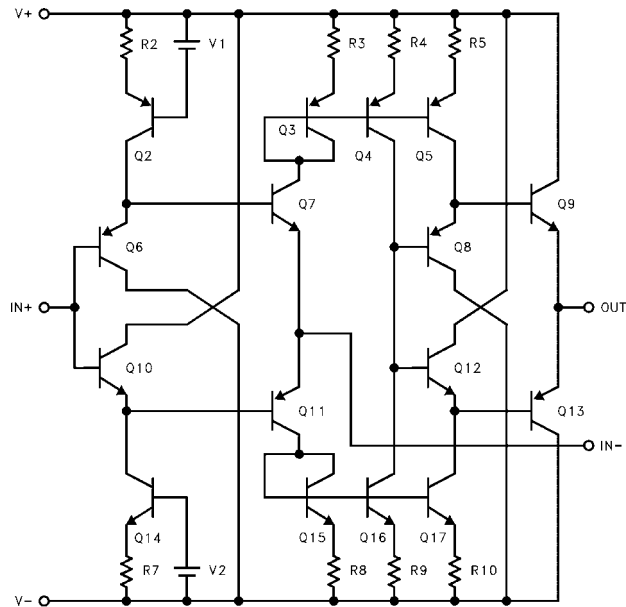

Applications Information

Product Description

The EL2260/EL2460 are dual and quad current mode feedback amplifiers that offer wide bandwidths and good video specifications at moderately low supply currents. They are built using Elantec's proprietary complimentary bipolar process and are offered in industry standard pinouts. Due to the current feedback architecture, the EL2260/EL2460 closed-loop 3dB bandwidth is dependent on the value of the feedback resistor. First the desired bandwidth is selected by choosing the feedback resistor, R_F , and then the gain is set by picking the gain resistor, R_G . The curves at the beginning of the Typical Performance Curves section show the effect of varying both R_F and R_G . The 3dB bandwidth is somewhat dependent on the power supply voltage. As the supply voltage is decreased, internal junction capacitances increase, causing a reduction in closed loop bandwidth. To compensate for this, smaller values of feedback resistor can be used at lower supply voltages.

Power Supply Bypassing and Printed Circuit Board Layout

As with any high frequency device, good printed circuit board layout is necessary for optimum performance. Ground plane construction is highly recommended. Lead lengths should be as short as possible, below 1/4". The power supply pins must be well bypassed to reduce the risk of oscillation. A 1.0 μ F tantalum capacitor in parallel with a 0.01 μ F ceramic capacitor is adequate for each supply pin.

For good AC performance, parasitic capacitances should be kept to a minimum, especially at the inverting input (see Capacitance at the Inverting Input section). This implies keeping the ground plane away from this pin. Carbon resistors are acceptable, while use of wire-wound resistors should not be used because of their parasitic inductance. Similarly, capacitors should be low inductance for best performance. Use of sockets, particularly for the SO packages, should be avoided. Sockets add parasitic inductance and capacitance which will result in peaking and overshoot.

Capacitance at the Inverting Input

Due to the topology of the current feedback amplifier, stray capacitance at the inverting input will affect the AC and transient performance of the EL2260/EL2460 when operating in the non-inverting configuration. The characteristic curve of gain vs. frequency with variations of C_{IN-} emphasizes this effect. The curve illustrates how the bandwidth can be extended to beyond 200MHz with some additional peaking with an additional 2pF of capacitance at the V_{IN-} pin for the case of $A_V = +2$. Higher values of capacitance will be required to obtain similar effects at higher gains.

In the inverting gain mode, added capacitance at the inverting input has little effect since this point is at a virtual ground and stray capacitance is therefore not "seen" by the amplifier.

Feedback Resistor Values

The EL2260 and EL2460 have been designed and specified with $R_F = 560\Omega$ for $A_V = +2$. This value of feedback resistor yields extremely flat frequency response with little to no peaking out to 130MHz. As is the case with all current feedback amplifiers, wider bandwidth, at the expense of slight peaking, can be obtained by reducing the value of the feedback resistor. Inversely, larger values of feedback resistor will cause rolloff to occur at a lower frequency. By reducing R_F to 430 Ω , bandwidth can be extended to 170MHz with under 1dB of peaking. Further reduction of R_F to 360 Ω increases the bandwidth to 195MHz with about 2.5dB of peaking. See the curves in the Typical Performance Curves section which show 3dB bandwidth and peaking vs. frequency for various feedback resistors and various supply voltages.

Bandwidth vs Temperature

Whereas many amplifier's supply current and consequently 3dB bandwidth drop off at high temperature, the EL2260/EL2460 were designed to have little supply current variations with temperature. An immediate benefit from this is that the 3dB bandwidth does not drop off drastically with temperature. With $V_S = \pm 15V$ and $A_V = +2$, the bandwidth only varies from 150MHz to 110MHz over the entire die junction temperature range of $0^\circ C < T < 150^\circ C$.

Supply Voltage Range

The EL2260/EL2460 has been designed to operate with supply voltages from $\pm 2V$ to $\pm 15V$. Optimum bandwidth, slew rate, and video characteristics are obtained at higher supply voltages. However, at $\pm 2V$ supplies, the 3dB bandwidth at $A_V = +2$ is a respectable 70MHz. The following figure is an oscilloscope plot of the EL2260 at $\pm 2V$ supplies, $A_V = +2$, $R_F = R_G = 560\Omega$, driving a load of 150 Ω , showing a clean $\pm 600mV$ signal at the output.

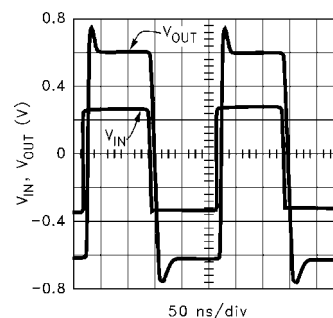

If a single supply is desired, values from +4V to +30V can be used as long as the input common mode range is not exceeded. When using a single supply, be sure to either 1)

EL2260, EL2460

DC bias the inputs at an appropriate common mode voltage and AC couple the signal, or 2) ensure the driving signal is within the common mode range of the EL2260/EL2460.

Settling Characteristics

The EL2260/EL2460 offer superb settling characteristics to 0.1%, typically in the 35ns to 40ns range. There are no aberrations created from the input stage which often cause longer settling times in other current feedback amplifiers. The EL2260/EL2460 are not slew rate limited, therefore any size step up to $\pm 10V$ gives approximately the same settling time.

As can be seen from the Long Term Settling Error curve, for $A_V = +1$, there is approximately a 0.035% residual which tails away to 0.01% in about 40 μ s. This is a thermal settling error caused by a power dissipation differential (before and after the voltage step). For $A_V = -1$, due to the inverting mode configuration, this tail does not appear since the input stage does not experience the large voltage change as in the non-inverting mode. With $A_V = -1$, 0.01% settling time is slightly greater than 100ns.

Power Dissipation

The EL2260/EL2460 amplifiers combine both high speed and large output current drive capability at a moderate supply current in very small packages. It is possible to exceed the maximum junction temperature allowed under certain supply voltage, temperature, and loading conditions. To ensure that the EL2260/EL2460 remain within their absolute maximum ratings, the following discussion will help to avoid exceeding the maximum junction temperature.

The maximum power dissipation allowed in a package is determined by its thermal resistance and the amount of temperature rise according to:

$$P_{DMAX} = \frac{T_{JMAX} - T_{AMAX}}{\theta_{JA}}$$

The maximum power dissipation actually produced by an IC is the total quiescent supply current times the total power supply voltage plus the power in the IC due to the load, or

$$P_{DMAX} = N \times \left(2 \times V_S \times I_S + (V_S - V_{OUT}) \times \frac{V_{OUT}}{R_L} \right)$$

where N is the number of amplifiers per package, and I_S is the current per amplifier. (To be more accurate, the quiescent supply current flowing in the output driver transistor should be subtracted from the first term because, under loading and due to the class AB nature of the output stage, the output driver current is now included in the second term.)

In general, an amplifier's AC performance degrades at higher operating temperature and lower supply current.

Unlike some amplifiers, such as the LT1229 and LT1230, the EL2260/EL2460 maintain almost constant supply current over temperature so that AC performance is not degraded as much over the entire operating temperature range. Of course, this increase in performance doesn't come for free. Since the current has increased, supply voltages must be limited so that maximum power ratings are not exceeded.

Each amplifier in the EL2260/EL2460 consume typically 7.5mA and maximum 10.0mA. The worst case power in an IC occurs when the output voltage is at half supply, if it can go that far, or its maximum value if it cannot reach half supply. If we assume that the EL2260/EL2460 is used for double terminated video cable driving applications ($R_L = 150\Omega$), and the gain = +2, then the maximum output voltage is 2V, and the average output voltage is 1.4V. If we set the two P_{Dmax} equations equal to each other, and solve for V_S , we can get a family of curves for various packages and conditions according to:

$$V_S = \frac{R_L \times (T_{JMAX} - T_{AMAX})}{N \times \theta_{JA}} + (V_{OUT})$$

$$V_S = \frac{(2 \times I_S \times R_L) + V_{OUT}}{(2 \times I_S \times R_L) + V_{OUT}}$$

The following curve shows supply voltage ($\pm V_S$) vs. temperature for the various packages assuming $A_V = +2$, $R_L = 150$, and V_{OUT} peak = 2V. The curves include worst case conditions ($I_S = 10$ mA and all amplifiers operating at V_{OUT} peak = 2V).

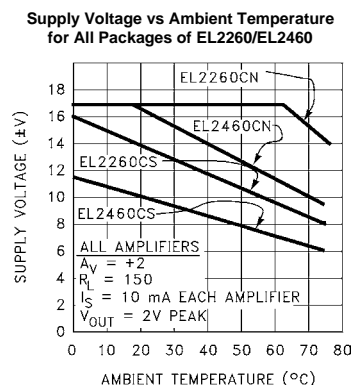

The curves do not include heat removal or forcing air, or the simple fact that the package will probably be attached to a circuit board, which can also provide some form of heat removal. Larger temperature and voltage ranges are possible with heat removal and forcing air past the part.

Current Limit

The EL2260/EL2460 have internal current limits that protect the circuit in the event of the output being shorted to ground. This limit is set at 100mA nominally and reduces with junction temperature. At a junction temperature of 150°C, the current limits at about 65mA. If any one output is shorted to ground, the power dissipation could be well over 1W, and much greater if all outputs are shorted. Heat removal is



EL2260, EL2460

required in order for the EL2260/EL2460 to survive an indefinite short.

Channel to Channel Isolation

Due to careful biasing connections within the internal circuitry of the EL2260/EL2460, exceptionally good channel to channel isolation is obtained. Isolation is over 70dB at video frequencies of 4MHz, and over 65dB up to 10MHz. The EL2460 isolation is improved an additional 10dB, up to about 5MHz, for amplifiers A to B and amplifiers C to D. Isolation is improved another 8dB for amplifiers A to C and amplifiers B to D. See the curve in the Typical Performance Curves section for more detail.

Driving Cables and Capacitive Loads

When used as a cable driver, double termination is always recommended for reflection-free performance. For those applications, the back termination series resistor will decouple the EL2260 and EL2460 from the capacitive cable and allow extensive capacitive drive. However, other applications may have high capacitive loads without termination resistors. In these applications, an additional small value (5Ω – 50Ω) resistor in series with the output will eliminate most peaking. The gain resistor, R_G , can be chosen to make up for the gain loss created by this additional series resistor at the output.



EL2260, EL2460

EL2260/EL2460 Macromodel

* Revision A, March 1993

* AC Characteristics used C_{IN^-} (pin 2) = 1pF; $R_F = 560\Omega$

* Connections:

	+input				
*		-input			
*			+Vsupply		
*				-Vsupply	
*					output
*					
.subckt EL2260/EL	3	2	7	4	6

* Input Stage

e1 10 0 3 0 1.0
vis 10 9 0V
h2 9 12 vxx 1.0
r1 2 11 130
l1 11 12 25nH
iinp 3 0 0.5 μ A
iinm 2 0 5 μ A
r12 3 0 2Meg

* Slew Rate Limiting

h1 13 0 vis 600
r2 13 14 1K
d1 14 0 dclamp
d2 0 14 dclamp

* High Frequency Pole

*e2 30 0 14 0 0.001666666666
l3 30 17 0.43 μ H
c5 17 0 0.27pF
r5 17 0 500

* Transimpedance Stage

g1 0 18 17 0 1.0
ro1 18 0 2Meg
cdp 18 0 2.285pF

* Output Stage

q1 4 18 19 qp
q2 7 18 20 qn
q3 7 19 21 qn
q4 4 20 22 qp
r7 21 6 4
r8 22 6 4
ios1 7 19 2mA
ios2 20 4 2mA

* Supply Current

ips 7 4 2mA

* Error Terms

ivos 0 23 2mA



EL2260, EL2460

```

vxx 23 0 0V
e4 24 0 3 0 1.0
e5 25 0 7 0 1.0
e6 26 0 4 0 1.0
r9 24 23 562
r10 25 23 1K
r11 26 23 1K

```

```

*
* Models
*

```

```

.model qn npn (is=5e-15 bf=100 tf=0.1ns)
.model qp pnp (is=5e-15 bf=100 tf=0.1ns)
.model dclamp d (is=1e-30 ibv=0.266 bv=2.24 n=4)
.ends

```

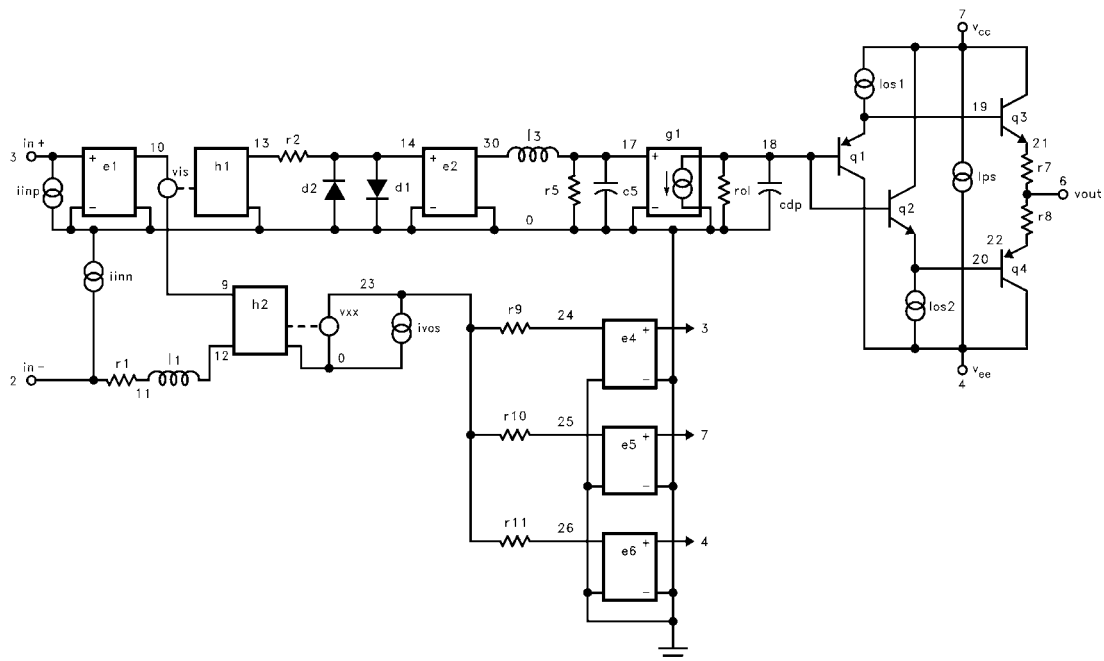

All Intersil U.S. products are manufactured, assembled and tested utilizing ISO9000 quality systems.
Intersil Corporation's quality certifications can be viewed at www.intersil.com/design/quality

Intersil products are sold by description only. Intersil Corporation reserves the right to make changes in circuit design, software and/or specifications at any time without notice. Accordingly, the reader is cautioned to verify that data sheets are current before placing orders. Information furnished by Intersil is believed to be accurate and reliable. However, no responsibility is assumed by Intersil or its subsidiaries for its use; nor for any infringements of patents or other rights of third parties which may result from its use. No license is granted by implication or otherwise under any patent or patent rights of Intersil or its subsidiaries.

For information regarding Intersil Corporation and its products, see www.intersil.com

