

SIEMENS

RED HDSP2000LP
 YELLOW HDSP2001LP
 HIGH EFFICIENCY RED HDSP2002LP
 GREEN HDSP2003LP
 .150" 4-Character 5x7 Dot Matrix
 Serial Input Alphanumeric Display

Intelligent
Display Devices

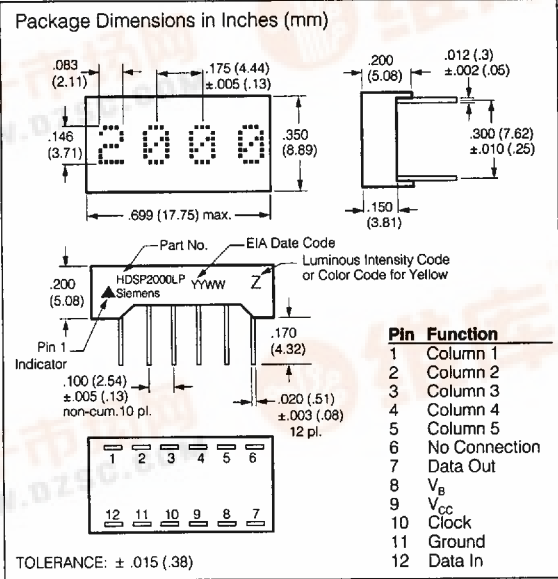
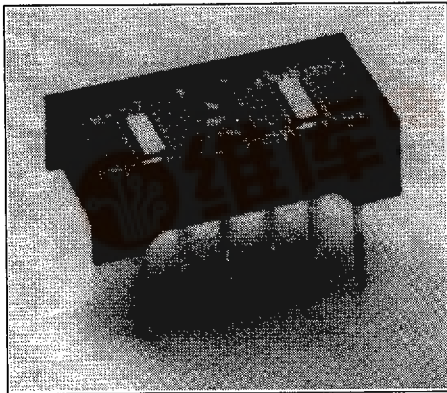

FEATURES

- Four 0.150" Dot Matrix Characters
- Four Colors: Red, Yellow, High Efficiency Red, Green
- Wide Viewing Angle: X Axis +50°
Y Axis +75°
- Built-in CMOS Shift Registers with Constant Current LED Row Drivers
- Shift Registers Allow Custom Fonts
- Easily Cascaded for Multiple Displays
- TTL Compatible
- End Stackable
- Extended Operating Temperature Range: -40°C to + 85°C
- Categorized for Luminous Intensity
- All Displays Color Matched
- Compact Plastic Package
- 100% Burned In and Tested

DESCRIPTION

The HDSP200XLP are four digit 5x7 dot matrix serial input alphanumeric displays. The displays are available in red, yellow, high efficiency red, or bright green. The package is a standard twelve-pin DIP with a flat plastic lens. The display can be stacked horizontally or vertically to form messages of any length.

The HDSP200XLP has two fourteen-bit CMOS shift registers with built-in row drivers. These shift registers drive twenty-eight rows and enable the design of customized fonts. Cascading multiple displays is possible because of the Data In and Data Out pins. Data In and Out are easily input with the clock signal and displayed in parallel on the row drivers. Data Out represents the output of the 7th bit of digit number four shift register. The shift register is level triggered. The like columns of each character in a display cluster are tied to a single pin (see Block Diagram). High true data in the shift register enables the output current mirror driver stage associated with each row of LEDs in the 5x7 diode array.

The TTL compatible V_B input may either be tied to V_{CC} for maximum display intensity or pulse width modulated to achieve intensity control and reduce power consumption.

—Continued

See Appnote 44 for application information.



DESCRIPTION (Continued)

In the normal mode of operation, input data for digit four, column one is loaded into the seven on-board shift register locations one through seven. Column one data for digits 3, 2, and 1 is shifted into the display shift register locations. Then column one input is enabled for an appropriate period of time, T. A similar process is repeated for columns 2, 3, 4, and 5. If the decode time and load data time into the shift register is t, then with five columns, each column of the display is operating at a duty factor of:

$$DF = \frac{T}{5(T+t)}$$

T+t, allotted to each display column, is generally chosen to provide the maximum duty factor consistent with the minimum refresh rate necessary to achieve a flicker free display. For most strobed display systems, each column of the display should be refreshed (turned on) at a minimum rate of 100 times per second.

With columns to be addressed, this refresh rate then gives a value for the time T+t of: $1/[5 \times (100)] = 2$ msec. If the device is operated at 5.0 MHz clock rate maximum, it is possible to maintain $t \ll T$. For short display strings, the duty factor will then approach 20%.

Maximum Ratings

Supply Voltage V_{CC} to GND -0.5 V to + 7.0 V
 Inputs, Data Out and V_B -0.5 V to V_{CC} + 0.5 V
 Column Input Voltage, V_{COL} -0.5 V to + 6.0 V
 Operating Temperature Range -40°C to +85°C
 Storage Temperature Range -40°C to + 100°C
 Maximum Solder Temperature, 0.063" (1.59 mm) below Seating Plane, $t < 5$ sec 260°C
 Maximum Allowable Power Dissipation at $T_{amb} = 25$ C⁽¹⁾ 0.86 W

Note:

- Maximum allowable dissipation is derived from $V_{CC} = 5.25$ V, $V_B = 2.4$ V, $V_{COL} = 3.5$ V, 20 LEDs on per character, 20% DF.

Figure 1. Timing Characteristics

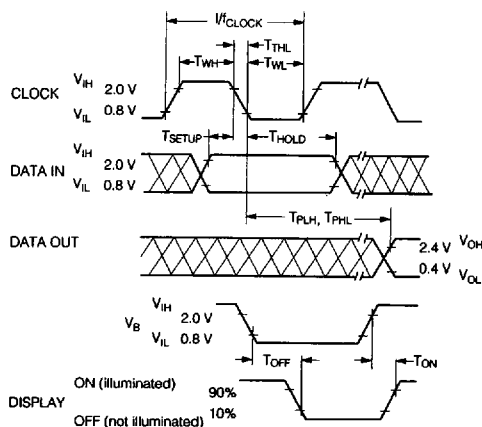
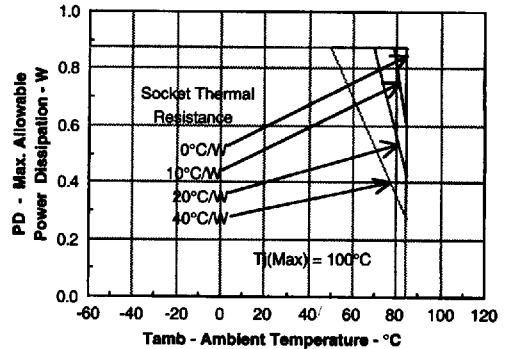

Figure 2. Maximum Allowable Power Dissipation versus Temperature



AC Electrical Characteristics

($V_{CC} = 4.75$ to 5.25 V, $T_{amb} = -40^\circ\text{C}$ to 85°C)

Symbol	Description	Min.	Typ.	Max. (1)	Units	Fig.
T_{SETUP}	Setup Time	50			ns	1
T_{HOLD}	Hold Time	25			ns	1
T_{WL}	Clock Width Low	75			ns	1
T_{WH}	Clock Width High	75			ns	1
$F_{(CLK)}$	Clock Frequency	0		5	MHz	1
T_{THL}	Clock Transi- tion Time			200	ns	1
T_{TLH}						
T_{PHL}	Propagation Delay Clock to Data Out			125	ns	1
T_{PLH}						

Note:

- V_B Pulse Width Modulation Frequency—50 KHz (max).

Cleaning the Displays

IMPORTANT—Do not use cleaning agents containing alcohol of any type with this display. The least offensive cleaning solution is hot D.I. water (60°C) for less than 15 minutes. Addition of mild saponifiers is acceptable. Do not use commercial dishwasher detergents.

For post solder cleaning use water or non-alcohol mixtures formulated for vapor cleaning processing or non-alcohol mixtures formulated for room temperature cleaning. Nonalcohol vapor cleaning processing for up to two minutes in vapors at boiling is permissible. For suggested solvents refer to Siemens Appnote 19.



Recommended Operating Conditions

Parameter	Symbol	Min.	Nom.	Max.	Units
Supply Voltage	V_{CC}	4.75	5.0	5.25	V
Data Out Current, Low State	I_{OL}			1.6	mA
Data Out Current, High State	I_{OH}	-0.5			mA
Column Input Voltage, Column On HDSP2000LP ⁽¹⁾	V_{COL}	2.4		3.5	V
Column Input Voltage, Column On, HDSP2001LP/2002LP/2003LP ⁽¹⁾	V_{COL}	2.75		3.5	V
Setup Time	T_{SETUP}	70			ns
Hold Time	T_{HOLD}	30			ns
Width of Clock	$T_{W(CLK)}$	75			ns
Clock Frequency	T_{CLK}			5	MHz
Clock Transition Time	T_{THL}			200	ns

Note: 1. See Figure 3: Peak Column Current vs. Column Voltage

Optical Characteristics**Red HDSP2000LP**

Description	Symbol	Min.	Typ. ⁽⁴⁾	Max.	Units	Test Conditions
Peak Luminous Intensity per LED ^(1,3) (Character Average)	I_{VPEAK}	105	200		μcd	$V_{CC} = 5.0\text{ V}$, $V_{COL} = 3.5\text{ V}$ $T_{amb} = 25^\circ\text{C}$, $V_B = 2.4\text{ V}$
Peak Wavelength	λ_{VPEAK}		655		nm	
Dominant Wavelength ⁽²⁾	λ_D		639		nm	

Yellow HDSP2001LP

Description	Symbol	Min.	Typ. ⁽⁴⁾	Max.	Units	Test Conditions
Peak Luminous Intensity per LED ^(1,3) (Character Average)	I_{VPEAK}	400	1140		μcd	$V_{CC} = 5.0\text{ V}$, $V_{COL} = 3.5\text{ V}$ $T_{amb} = 25^\circ\text{C}$, $V_B = 2.4\text{ V}$
Peak Wavelength	λ_{VPEAK}		583		nm	
Dominant Wavelength ⁽²⁾	λ_D		585		nm	

High Efficiency Red HDSP2002LP

Description	Symbol	Min.	Typ. ⁽⁴⁾	Max.	Units	Test Conditions
Peak Luminous Intensity per LED ^(1,3) (Character Average)	I_{VPEAK}	400	1430		μcd	$V_{CC} = 5.0\text{ V}$, $V_{COL} = 3.5\text{ V}$ $T_{amb} = 25^\circ\text{C}$, $V_B = 2.4\text{ V}$
Peak Wavelength	λ_{VPEAK}		635		nm	
Dominant Wavelength ⁽²⁾	λ_D		626		nm	

Green HDSP2003LP

Description	Symbol	Min.	Typ. ⁽⁴⁾	Max.	Units	Test Conditions
Peak Luminous Intensity per LED ^(1,3) (Character Average)	I_{VPEAK}	650	1550		μcd	$V_{CC} = 5.0\text{ V}$, $V_{COL} = 3.5\text{ V}$ $T_{amb} = 25^\circ\text{C}$, $V_B = 2.4\text{ V}$
Peak Wavelength	λ_{VPEAK}		565		nm	
Dominant Wavelength ⁽²⁾	λ_D		569		nm	

Notes:

- The displays are categorized for luminous intensity with the intensity category designated by a letter code on the bottom of the package.
- Dominant wavelength (λ_D) is derived from the CIE chromaticity diagram and represents the single wavelength which defines the color of the device

- The luminous sterance of the LED may be calculated using the following relationships:

$$L_v (\text{cd/m}^2) = I_v (\text{Candela})/\text{A (Meter)}^2$$

$$L_v (\text{Footlamberts}) = \pi I_v (\text{Candela})/\text{A (Foot)}^2$$

$$\text{HDSP2000LP, A} = 5.58 \times 10^{-8} \text{ m}^2 = 6 \times 10^{-7} \text{ ft.}^2$$

$$\text{HDSP2001/2/3LP, A} = 7.8 \times 10^{-6} \text{ m}^2 = 8.4 \times 10^{-7} \text{ ft.}^2$$

- All typical values specified at $V_{CC} = 5.0\text{ V}$ and $T_{amb} = 25^\circ\text{C}$ unless otherwise noted.



Electrical Characteristics (–40°C to +85°C, unless otherwise specified)

Description	Symbol	Min.	Typ. ⁽¹⁾	Max.	Units	Test Conditions
Supply Current (quiescent)	I_{CC}		1	5	mA	$V_B=0.4$ V $V_{CC}=5.25$ V $V_{CLK}=V_{DATA}=2.4$ V All SR Stages=Logical 1
			1	5	mA	$V_B=2.4$ V
Supply Current (operating)	I_{CC}		1.5	10.0	mA	$F_{CLK}=5$ MHz
Column Current at any Column Input ⁽²⁾	I_{COL} (All)			10	μ A	$V_B=0.4$ V $V_{CC}=5.25$ V $V_{COL}=3.5$ V All SR Stages=Logical 1
	I_{COL}		335	410	mA	$V_B=2.4$ V
V_B , Clock or Data Input Threshold Low	V_{IL}			0.8	V	$V_{CC}=4.75$ V– 5.25 V
V_B , Clock or Data Input Threshold High	V_{IH}	2.0			V	
Data Out Voltage	V_{OH}	2.4			V	$I_{OH}=-0.5$ mA $V_{CC}=4.75$ V $I_{OL}=1.6$ mA $I_{OL}=0$ mA
	V_{OL}			0.4	V	
Input Current Logical 0 V_B only	I_{IL}	-30	-110	-300	μ A	$V_{CC}=4.75$ V– 5.25 V, $V_{IL}=0.8$ V
Input Current Logical 0 Data, Clock	I_{IL}		-1	-10	μ A	
Power Dissipation per Package ⁽²⁾	P_D		0.4		W	$V_{CC}=5.0$, $V_{COL}=3.5$ V, 17.5% DF 15 LEDs on per character, $V_B=2.4$ V
Thermal Resistance IC Junction-to-Ambient	$R\theta_{JA}$		85		$^{\circ}$ C/W/ Device	

Notes:

1. All typical values specified at $V_{CC}=5.0$ V and $T_{amb}=25^{\circ}$ C unless otherwise noted.
2. See Figure 3–Peak Column Current vs. Column Voltage

Figure 3. Peak Column Current versus Column Voltage

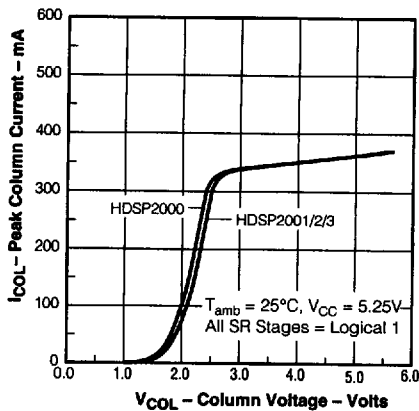
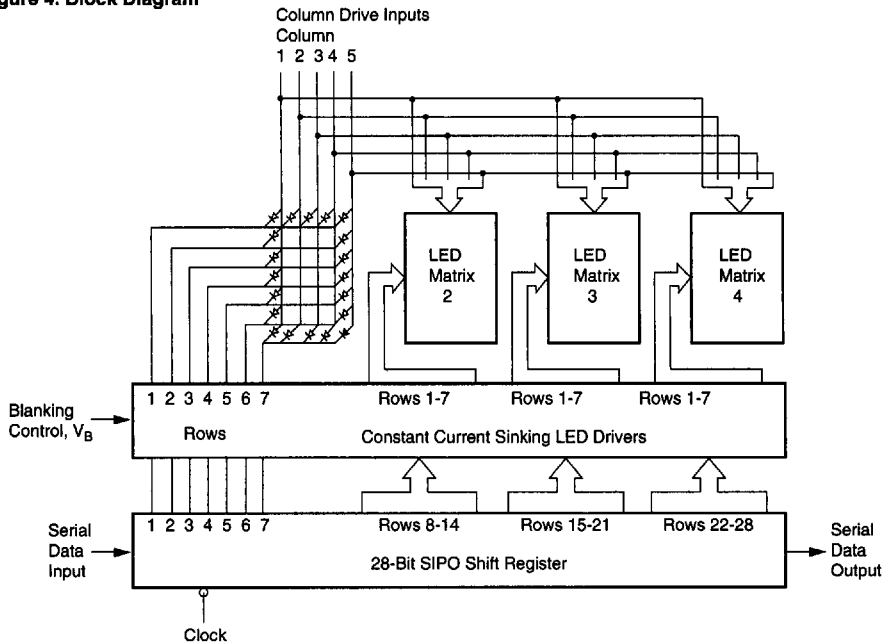

Figure 4. Block Diagram



Contrast Enhancement Filters

Display Color	Ambient Lighting		
	Dim	Moderate	Bright
HDSP2000LP Red	Panelgraphic Dark Red 63 Panelgraphic Ruby Red 60 Chequers Red 118 Plexiglass 2423	Polaroid HNC37 3M Light Control Film Panelgraphic Gray 10 Chequers Gray 105	
HDSP2001LP Yellow	Panelgraphic Yellow 27		Polaroid HNC10-Glass* Marks Polarized MPC 30-25C**
HDSP2002LP HER	Panelgraphic Ruby Red 60 Chequers Red 112		Note 1 Polaroid HNC10-Glass* Marks Polarized MPC 20-15C**
HDSP2003LP Bright Green	Panelgraphic Green 48 Chequers Green 107		Polaroid HNC10-Glass* Marks Polarized MPC 50-12C**

Note:
1. Optically coated circular polarized filters, such as Polaroid HNC10.

* Polaroid Corp.
1 Upland Rd., Bldg #2
Norwood, MA 02062
800/225-2770

** Marks Polarized Corp.
25-B Jefryn Blvd. W
Deer Park, NY 11729
516/242-1300
FAX 516/242-1347
Marks Polarized Corp. manufactures
to MIL-1-45208 inspection system.

General Quality Assurance Levels
Generic data available.



Thermal Considerations

The small alphanumeric displays are hybrid LED and CMOS assemblies that are designed for reliable operation in commercial, industrial, and military environments. Optimum reliability and optical performance will result when the junction temperature of the LEDs and CMOS ICs are kept as low as possible.

Thermal Modeling

HDSP200XLP displays consist of two driver ICs and four 5x7 LED matrixes. A thermal model of the display is shown in Figure 5. It illustrates that the junction temperature of the semiconductor = junction self heating + the case temperature rise + the ambient temperature. Equation 1 shows this relationship.

Figure 5. Thermal Model

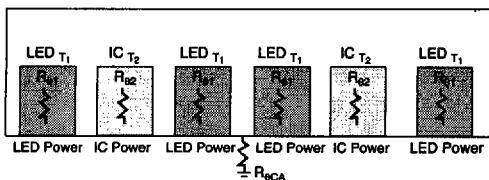

See Equation 1 below.

The junction rise within the LED is the product of the thermal impedance of an individual LED (37°C/W, DF = 20%, F = 200 Hz), times the forward voltage, $V_{F(LED)}$, and forward current $I_{F(LED)}$, of 13 - 14.5 mA. This rise averages $T_{J(LED)} = 1^\circ\text{C}$. The table below shows the $V_{F(LED)}$ for the respective displays.

Model Number	VF		
	Min.	Typ.	Max.
HDSP2000LP	1.6	1.7	2.0
HDSP2001/2/3LP	1.9	2.2	3.0

The junction rise within the LED driver IC is the combination of the power dissipated by the IC quiescent current and the 28 row driver current sinks. The IC junction rise is given in Equation 2.

A thermal resistance of 28°C/W results in a typical junction rise of 6°C.

See Equation 2 below.

Equation 1.

$$T_{J(LED)} = P_{LED} Z_{\theta JC} + P_{CASE} (R_{\theta JC} + R_{\theta CA}) + T_A$$

$$T_{J(LED)} = [(I_{COL}/28) V_{F(LED)} Z_{\theta JC}] + [(n/35) I_{COL} DF (5 V_{COL} + V_{CC} I_{CC}) \cdot [R_{\theta JC} + R_{\theta CA}] + T_A$$

Equation 2.

$$T_{J(IC)} = P_{COL} (R_{\theta JC} + R_{\theta CA}) + T_A$$

$$T_{J(IC)} = [5 (V_{COL} - V_{F(LED)}) \cdot (I_{COL} / 2) \cdot (n/35) DF + V_{CC} \cdot I_{CC}] \cdot [R_{\theta JC} + R_{\theta CA}] + T_A$$

For ease of calculations the maximum allowable electrical operating condition is dependent upon the aggregate thermal resistance of the LED matrixes and the two driver ICs. All of the thermal management calculations are based upon the parallel combination of these two networks which is 15°C/W. Maximum allowable power dissipation is given in Equation 3.

Equation 3.

$$P_{DISPLAY} = \frac{T_{J(MAX)} - T_A}{R_{\theta JC} + R_{\theta CA}}$$

$$P_{DISPLAY} = 5 V_{COL} I_{COL} (n/35) DF + V_{CC} I_{CC}$$

For further reference see Figures 2, 7, 8, 9, 10 and 11.

Key to Equation Symbols

DF	Duty factor
I_{CC}	Quiescent IC current
I_{COL}	Column current
n	Number of LEDs on in a 5 x 7 array
P_{CASE}	Package power dissipation excluding LED under consideration
P_{COL}	Power dissipation of a column
$P_{DISPLAY}$	Power dissipation of the display
P_{LED}	Power dissipation of an LED
$R_{\theta CA}$	Thermal resistance case to ambient
$R_{\theta JC}$	Thermal resistance junction to case
T_A	Ambient temperature
$T_{J(IC)}$	Junction temperature of an IC
$T_{J(LED)}$	Junction temperature of a LED
$T_{J(MAX)}$	Maximum junction temperature
V_{CC}	IC voltage
V_{COL}	Column voltage
$V_{F(LED)}$	Forward voltage of LED
$Z_{\theta JC}$	Thermal impedance junction to case



Optical Considerations

The light output of the LEDs is inversely related to the LED diode's junction temperature as shown in Figure 6. For optimum light output, keep the thermal resistance of the socket or PC board as low as possible.

Figure 6. Normalized Luminous Intensity versus Junction Temperature

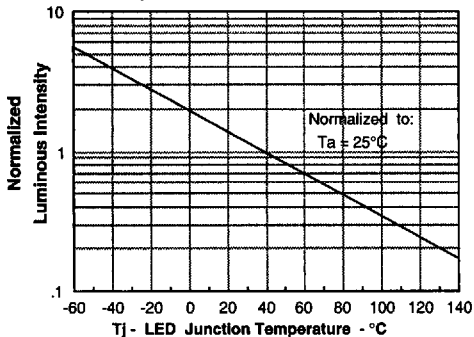

When mounted in a 10°C/W socket and operated at Absolute Maximum Electrical conditions, the HDSP200XLP will show an LED junction rise of 17°C. If $T_a = 40^\circ\text{C}$, then the LED's T_j will be 57°C. Under these conditions Figure 7 shows that the I_v will be 75% of its 25°C value.

Figure 7. Maximum LED Junction Temperature versus Socket Thermal Resistance

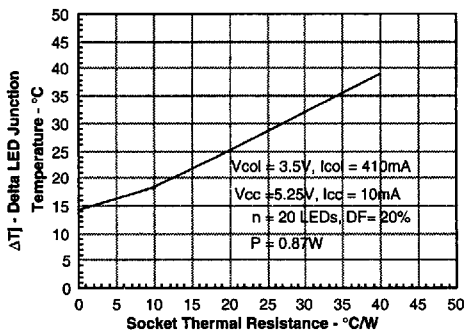

Figure 8. Maximum Package Power Dissipation

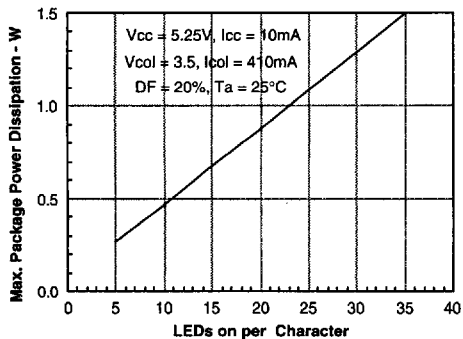

Figure 9. Package Power Dissipation

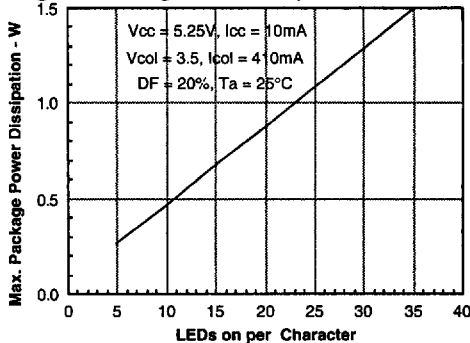

Figure 10. Maximum Character Power Dissipation

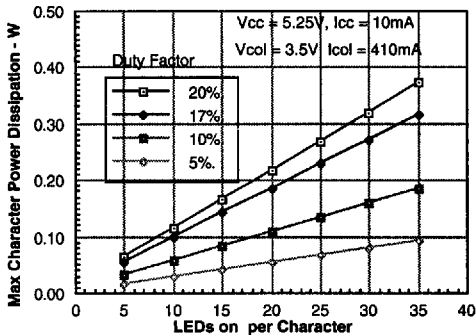

Figure 11. Character Power Dissipation

