

UTC M2115 LINEAR INTEGRATED CIRCUIT

DUAL OPERATIONAL AMPLIFIER

DESCRIPTION

The UTC M2115 is a low operating Voltage($\pm 1.0V$ min.) and low saturation output voltage($\pm 2.0V$ p-p at supply voltage $\pm 2.5V$) operational amplifier. It is applicable to handy type CD, radio cassette CD, and portable DAT, that are digital audio apparatus which require the 5V single supply operation and high output voltage. The UTC M2115 is improved version of the UTC M2100 about BIAS-CIRCUIT. So the UTC M2115 is low saturation compared to the UTC M2100 under the condition of low supply voltage($< \pm 2.5V$). The UTC M2115 is stable about the oscillation compared to the UTC M2100 under the condition of $V+/V- > 2.5V$.

FEATURES

- * Operating Voltage: $\pm 1V \sim \pm 7V$
- * Low Saturation Output Voltage: $\pm 2.0V_{p-p}@V+ = \pm 2.5V$
- * Slew Rate: $4V/\mu s$ (typ.)
- * Unity Gain Bandwidth: 12MHz (typ.)

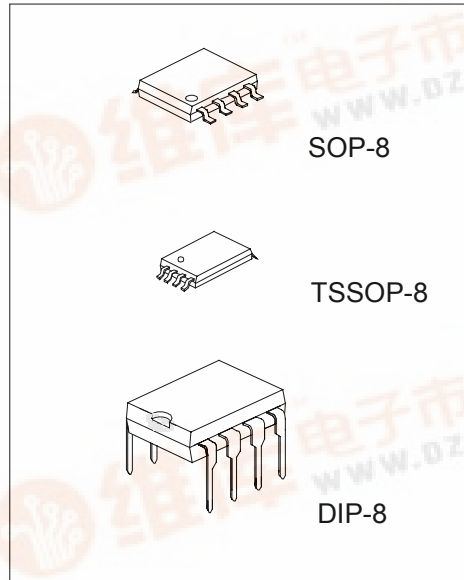

PIN CONFIGURATION

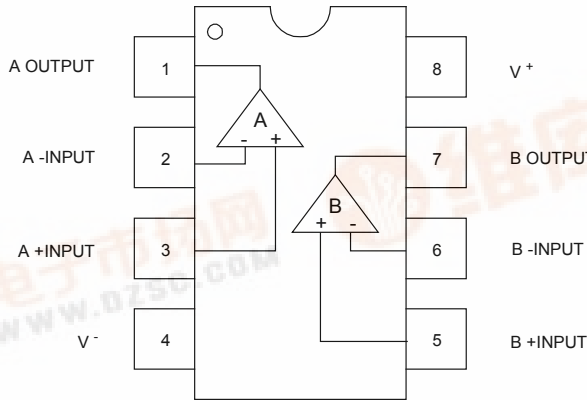

UTC M2115 LINEAR INTEGRATED CIRCUIT

EQUIVALENT CIRCUIT (1/2 Shown)

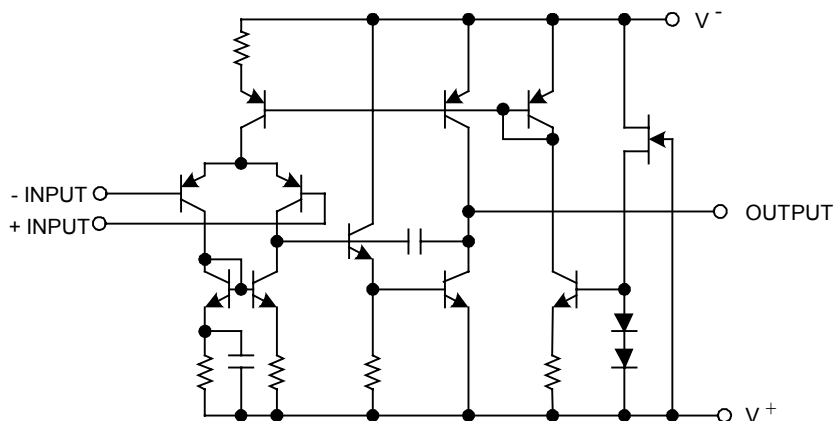

ABSOLUTE MAXIMUM RATINGS (Ta=25°C)

PARAMETER	SYMBOL	RATINGS	UNIT
Supply Voltage	V ⁺ V ⁻	±7.0	V
Differential Input Voltage	V _{ID}	±14	V
Power Dissipation	P _D	500	mW
DIP-8		300	
SOP-8 TSSOP-8		250	
Operating Temperature Range	T _{opr}	-40 ~ +85	°C
Storage Temperature Range	T _{stg}	-40 ~ +125	°C

ELECTRICAL CHARACTERISTICS (V⁺V⁻ = ±2.5V, Ta=25°C)

PARAMETER	SYMBOL	TEST CONDITION	MIN	TYP	MAX	UNIT
Input Offset Voltage	V _{IO}	R _s ≤ 10kΩ		1	6	mV
Input Bias Current	I _B			100	300	nA
Large Signal Voltage Gain	A _v	R _L ≥ 10kΩ	60	80		dB
Maximum Output Voltage Swing	V _{OM}	R _L ≥ 2.5kΩ	±2	±2.2		V
Input Common Mode Voltage Range	V _{ICM}		±1.5			V
Common Mode Rejection Ratio	CMR		60	74		dB
Supply Voltage Rejection Ratio	SVR		60	80		dB
Operating Current	I _{CC}	V _{IN} =0, R _L =∞		3.5	5	mA
Slew Rate	SR	A _v =1, V _{IN} =±1V		4		V/μs
Gain Bandwidth product	GB	f=10kHz		12		MHz

Note 1: Applied circuit voltage gain is desired to be operated within the range of 3dB to 30dB.

Note 2: Special care being required for input common mode voltage range and the oscillation due to the capacitive load when operating follower.



UTCM2115 LINEAR INTEGRATED CIRCUIT

TYPICAL CHARACTERISTICS

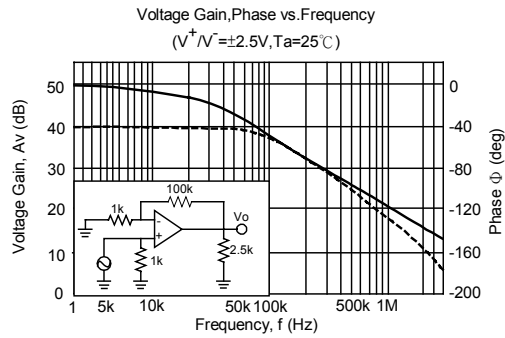
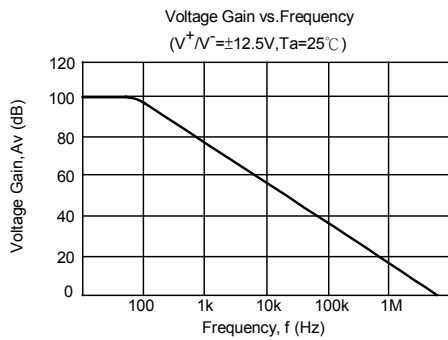
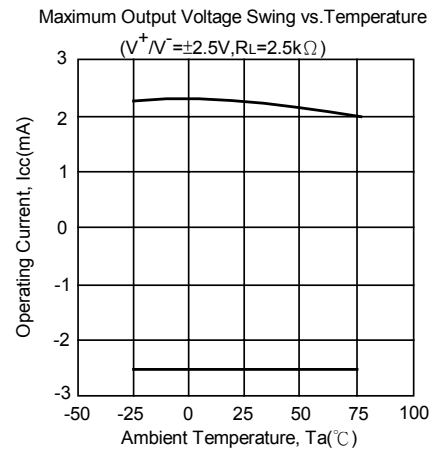
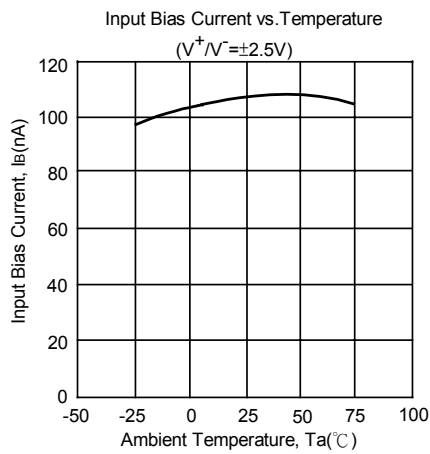
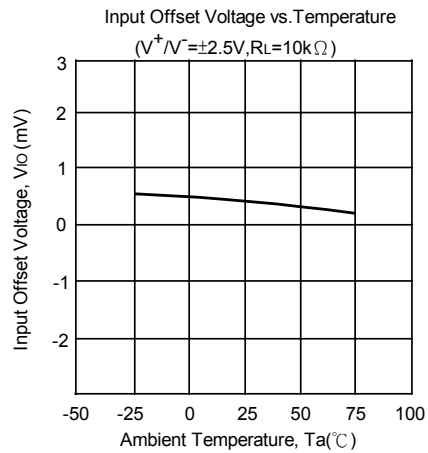
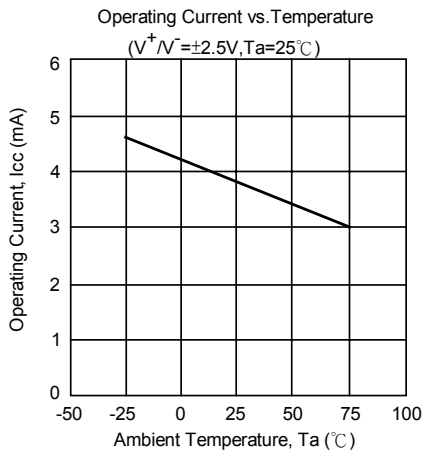

UTC M2115 LINEAR INTEGRATED CIRCUIT

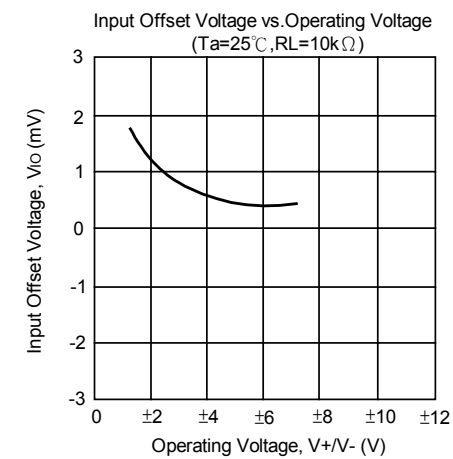
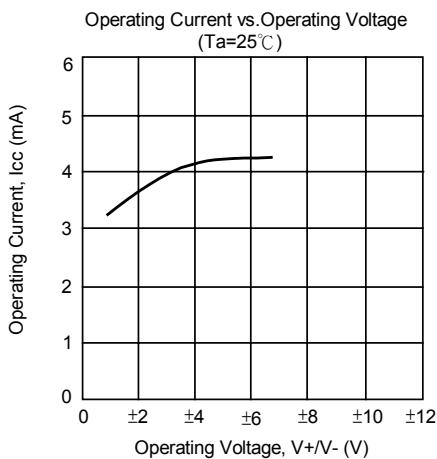
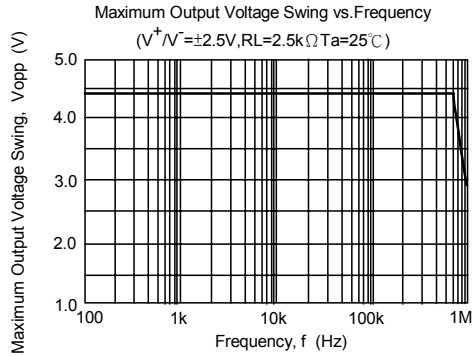
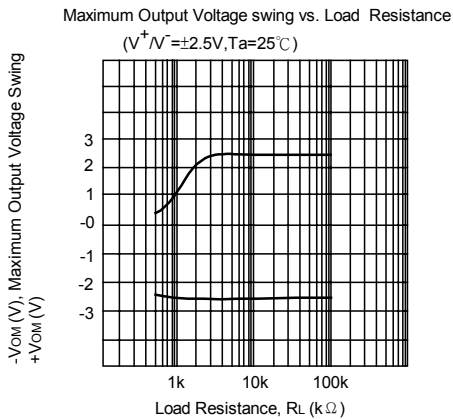
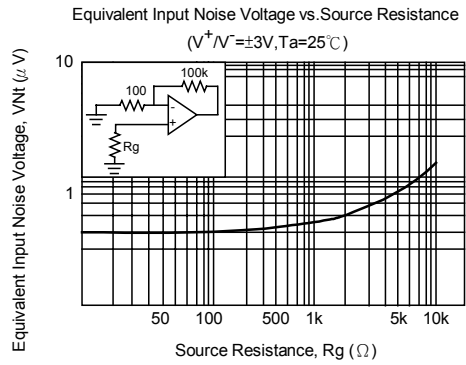
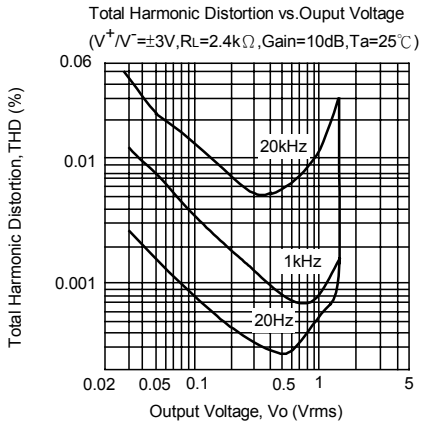

UTC M2115 LINEAR INTEGRATED CIRCUIT

Maximum Output Voltage swing vs. Operating Voltage
($R_L=2.5k\Omega$, $T_a=25^\circ\text{C}$)

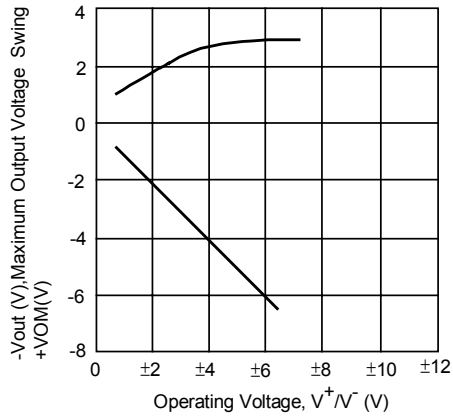

Input Bias Current vs. Operating Voltage
($T_a=25^\circ\text{C}$)

