

Features

- Two channel quadrature output
- Bushing or servo mount
- Square wave signal
- Index channel available
- Small size
- Resolution to 256PPR
- CMOS and TTL compatible
- Long life
- High operating speed

EN - Rotary Optical Encoder

Electrical Characteristics

Output	2-bit gray code, Channel A leads Channel B by 90° (electrical) with clockwise rotation
Supply Voltage	5.0 VDC ±0.25 VDC*
Supply Current	26 mA maximum
Output Voltage	
Low Output	0.8V maximum
High Output	4V minimum
Output Current	
Low Output	25mA minimum
Insulation Resistance (500 VDC)	1,000 megohms
Rise/Fall Time	200ns (typical)
Shaft RPM (Ball Bearing)	3,000 rpm maximum
Power Consumption	136 mW maximum
Pulse Width (Electrical Degrees, Each Channel)	180° ±45° TYP.
Pulse Width (Index Channel)	360° ±90°
Phase (Electrical Degrees, Channel A to Channel B)	90° ±45° TYP.
Index Channel Centered on 1-1 State Combination of A and B Channels	0° ±45°

*Consult factory for other voltages up to 15 VDC.

Environmental Characteristics

Operating Temperature Range (Standard)	-40°C to +85°C
Vibration	5G
Shock	50G
Humidity	MIL-STD-202, Method 103B, Condition B

Mechanical Characteristics

Torque (Starting and Running)	
A & C Bushings (Spring Loaded for Optimum Feel)	1.5 oz-in. maximum
W, S & T Bushings (Ball Bearing Shaft Support)	0.1 oz-in. maximum
Mechanical Rotation	Continuous
Shaft End Play	0.012" T.I.R. maximum
Shaft Radial Play	0.005" T.I.R. maximum
Rotational Life	
A & C Bushings (300 rpm maximum)**	10,000,000 revolutions
W, S & T Bushings (3,000 rpm maximum)**	200,000,000 revolutions
Weight	0.4 oz.

**For resolutions ≤ 128 quadrature cycles per shaft revolution.

OUTPUT TABLE

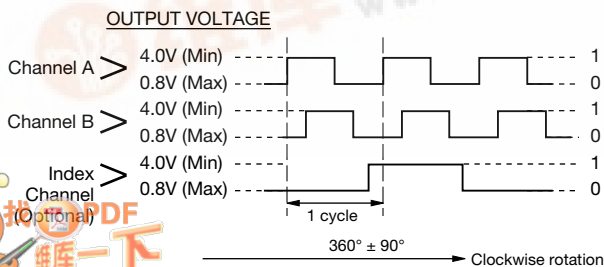

STANDARD RESOLUTIONS AVAILABLE

(Full quadrature output cycles per shaft revolution)	
25*	125
50*	128
64	200
100	256

For Non-Standard Resolutions—
Consult Factory

* Channel B leads Channel A

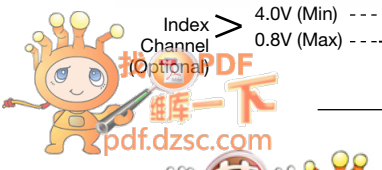

ROTARY OPTICAL

The Bourns® EN model is a self-contained rotary optical encoder. It produces a 2-bit quadrature signal which is suitable for digital systems where both magnitude and direction of adjustment must be provided. The EN encoder is ideal for use as a digital panel control or as a position sensing device in applications where long life, reliability, high resolution and precise linearity are critical.

The EN series encoder converts rotary input into electrical signals which can be used by microprocessors without A/D conversion.

Bourns encoder output signals are square wave digital pulses which do not require debounce circuitry. Both features make it possible to significantly reduce the memory overhead, wiring and wiring interconnects required by other types of control devices.

EN optical encoders offer a useful rotational life of from 10 million to 200 million shaft revolutions, making them ideal for extended service applications. The Bourns encoder is also compact and well suited for situations where the available space is limited.

EN - Rotary Optical Encoder

BOURNS®

Dimensional Drawings

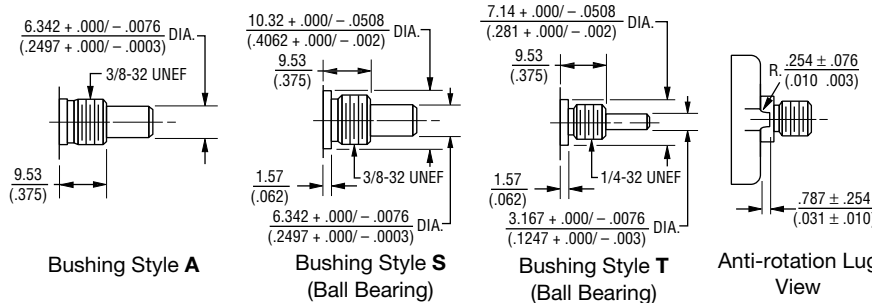
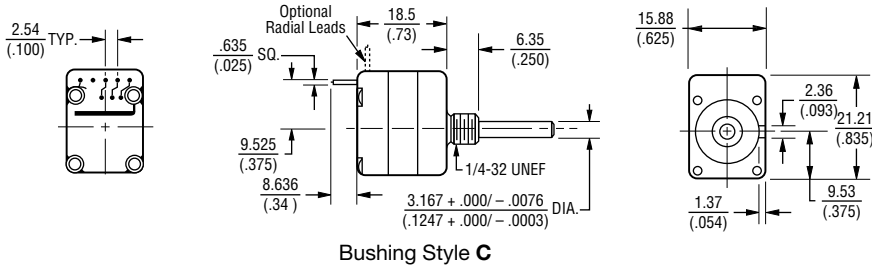

TERMINATION DIAGRAM

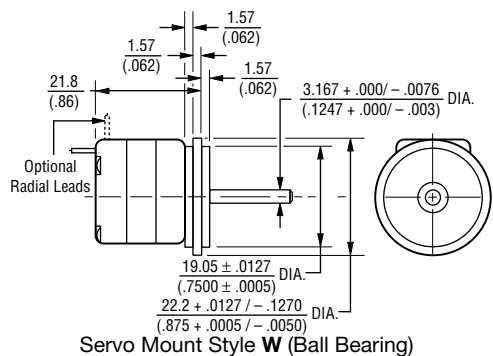
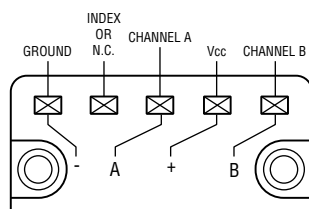

Consult factory for options not shown, including:

- Wire lead or cable options
- Connectors
- Non-standard resolutions
- Special shaft/bushing sizes and features
- Special performance characteristics
- PCB mounting bracket

How To Order

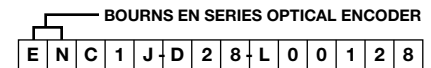

ANTI-ROTATION LUG POSITION	
Code	Description
D	None
J	9:00 Position
P	Rear Mounting Bracket

SHAFT LENGTH*	
Code	Description
16	1/2" Long
20	5/8" Long
28	7/8" Long

SWITCHING CONFIGURATION	
Code	Description
1	Channel A Leads Channel B By 90 (Clockwise Rotation)**
2	Code 1 Switching With Index Channel

TERMINAL*** CONFIGURATION	
Code	Description
L	Axial, Multi-Purpose Pin
R	Radial, Multi-Purpose Pin
M	Rear Ribbon Cable with Connector
N	Side Ribbon Cable with Connector
W	Rear Ribbon Cable - No Connector
Y	Side Ribbon Cable - No Connector

RESOLUTION	
Code	Cycles Per Revolution
00025	25
00050	50
00064	64
00100	100
00125	125
00128	128
00200	200
00256	256

SHAFT STYLE		
Code	Description	Use With Bushings (Code)
B	1/4" Dia., Plain End	A, S
D	1/8" Dia., Plain End	C, T, W
C	1/4" Dia., Single Flatted	A, S

BUSHING CONFIGURATION	
Code	Description
A	3/8"D X 3/8"L Threaded
C	1/4"D X 1/4"L Threaded
S	3/8"D X 3/8"L Threaded (Ball Bearing)
T	1/4"D X 3/8"L Threaded (Ball Bearing)
W	Servo Mount 7/8"D (Ball Bearing)

* Shaft length measured from mounting surface.
 ** 25 and 50ppr is reversed (Channel B leads Channel A)
 *** Standard ribbon cable is 10" long
 Consult factory for other lengths.

