

**Freescale Semiconductor**  
Technical Data

Document Number: MW7IC18100N  
Rev. 1, 6/2007



# RF LDMOS Wideband Integrated Power Amplifiers

The MW7IC18100N wideband integrated circuit is designed with on-chip matching that makes it usable from 1805 to 2050 MHz. This multi-stage structure is rated for 24 to 32 Volt operation and covers all typical cellular base station modulations including GSM EDGE and CDMA.

**Final Application**

- Typical GSM Performance:  $V_{DD} = 28$  Volts,  $I_{DQ1} = 180$  mA,  $I_{DQ2} = 1000$  mA,  $P_{out} = 100$  Watts CW, 1805-1880 MHz or 1930-1990 MHz  
Power Gain — 30 dB  
Power Added Efficiency — 48%

**GSM EDGE Application**

- Typical GSM EDGE Performance:  $V_{DD} = 28$  Volts,  $I_{DQ1} = 215$  mA,  $I_{DQ2} = 800$  mA,  $P_{out} = 40$  Watts Avg., 1805-1880 MHz or 1930-1990 MHz  
Power Gain — 31 dB  
Power Added Efficiency — 35%  
Spectral Regrowth @ 400 kHz Offset = -63 dBc  
Spectral Regrowth @ 600 kHz Offset = -80 dBc  
EVM — 1.5% rms
- Capable of Handling 5:1 VSWR, @ 28 Vdc, 1990 MHz, 100 Watts CW Output Power
- Stable into a 5:1 VSWR. All Spurs Below -60 dBc @ 1 mW to 120 W CW  $P_{out}$ .

**Features**

- Characterized with Series Equivalent Large-Signal Impedance Parameters and Common Source Scattering Parameters
- On-Chip Matching (50 Ohm Input, DC Blocked)
- Integrated Quiescent Current Temperature Compensation with Enable/Disable Function (1)
- Integrated ESD Protection
- 200°C Capable Plastic Package
- RoHS Compliant
- In Tape and Reel. R1 Suffix = 500 Units per 44 mm, 13 inch Reel.



**1990 MHz, 100 W, 28 V  
GSM/GSM EDGE  
RF LDMOS WIDEBAND  
INTEGRATED POWER AMPLIFIERS**

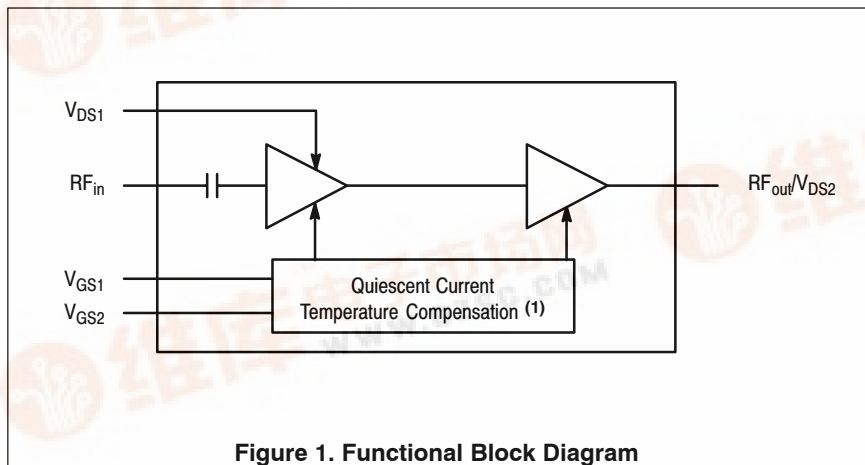
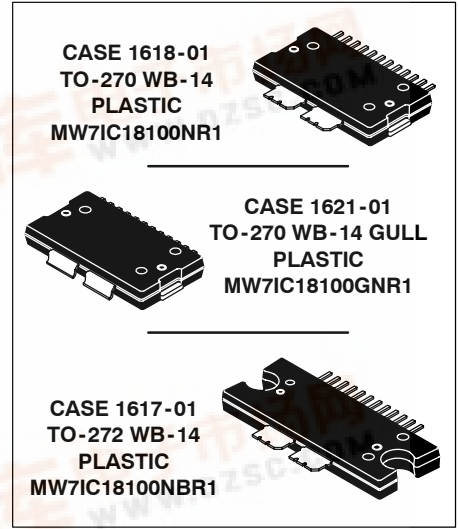
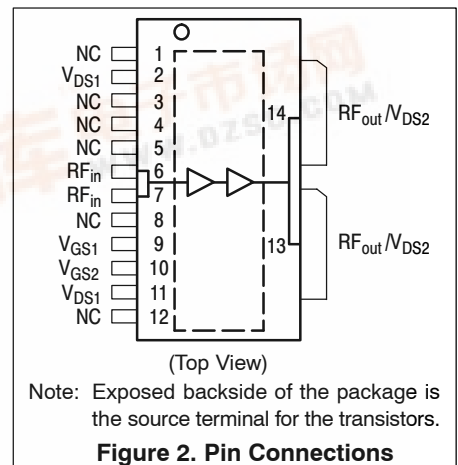

Figure 1. Functional Block Diagram



Note: Exposed backside of the package is the source terminal for the transistors.

Figure 2. Pin Connections

1. Refer to AN1977, Quiescent Current Thermal Tracking Circuit in the RF Integrated Circuit Family and to AN1987, Quiescent Current Control for the RF Integrated Circuit Device Family. Go to <http://www.freescale.com/rf>. Select Documentation/Application Notes - AN1977 or AN1987.



**Table 1. Maximum Ratings**

Rating	Symbol	Value	Unit
Drain-Source Voltage	$V_{DSS}$	-0.5, +65	Vdc
Gate-Source Voltage	$V_{GS}$	-0.5, +6	Vdc
Storage Temperature Range	$T_{stg}$	-65 to +200	°C
Operating Junction Temperature	$T_J$	200	°C

**Table 2. Thermal Characteristics**

Characteristic	Symbol	Value (1,2)	Unit
Thermal Resistance, Junction to Case GSM Application ( $P_{out} = 100$ W CW)	$R_{\theta JC}$	2.0 0.51	°C/W
		Stage 1, 28 Vdc, $I_{DQ1} = 180$ mA	
		Stage 2, 28 Vdc, $I_{DQ2} = 1000$ mA	

**Table 3. ESD Protection Characteristics**

Test Methodology	Class
Human Body Model (per JESD22-A114)	O (Minimum)
Machine Model (per EIA/JESD22-A115)	A (Minimum)
Charge Device Model (per JESD22-C101)	III (Minimum)

**Table 4. Moisture Sensitivity Level**

Test Methodology	Rating	Package Peak Temperature	Unit
Per JESD 22-A113, IPC/JEDEC J-STD-020	3	260	°C

**Table 5. Electrical Characteristics** ( $T_C = 25^\circ\text{C}$  unless otherwise noted)

Characteristic	Symbol	Min	Typ	Max	Unit
<b>Functional Tests</b> (In Freescale Test Fixture, 50 ohm system) $V_{DD} = 28$ Vdc, $P_{out} = 100$ W CW, $I_{DQ1} = 180$ mA, $I_{DQ2} = 1000$ mA, $f = 1990$ MHz.					
Power Gain	$G_{ps}$	27	30	31	dB
Input Return Loss	IRL	—	-15	-10	dB
Power Added Efficiency	PAE	45	48	—	%
$P_{out}$ @ 1 dB Compression Point, CW	P1dB	100	112	—	W

**Typical GSM EDGE Performances** (In Freescale GSM EDGE Test Fixture, 50 ohm system)  $V_{DD} = 28$  Vdc,  $I_{DQ1} = 215$  mA,  $I_{DQ2} = 800$  mA,  $P_{out} = 40$  W Avg., 1805-1880 MHz or 1930-1990 MHz EDGE Modulation.

Power Gain	$G_{ps}$	—	31	—	dB
Power Added Efficiency	PAE	—	35	—	%
Error Vector Magnitude	EVM	—	1.5	—	% rms
Spectral Regrowth at 400 kHz Offset	SR1	—	-63	—	dBc
Spectral Regrowth at 600 kHz Offset	SR2	—	-80	—	dBc

1. Refer to AN1955, *Thermal Measurement Methodology of RF Power Amplifiers*. Go to <http://www.freescale.com/rf>. Select Documentation/Application Notes - AN1955.
2. MTTF calculator available at <http://www.freescale.com/rf>. Select Tools/Software/Application Software/Calculators to access the MTTF calculators by product.



**Table 5. Electrical Characteristics** ( $T_C = 25^\circ\text{C}$  unless otherwise noted) **(continued)**

Characteristic	Symbol	Min	Typ	Max	Unit
<b>Typical Performances</b> (In Freescale Test Fixture, 50 ohm system) $V_{DD} = 28\text{ Vdc}$ , $I_{DQ1} = 180\text{ mA}$ , $I_{DQ2} = 1000\text{ mA}$ , 1930-1990 MHz Bandwidth					
Gain Flatness in 60 MHz Bandwidth @ $P_{out} = 100\text{ W CW}$	$G_F$	—	0.37	—	dB
Average Deviation from Linear Phase in 60 MHz Bandwidth @ $P_{out} = 100\text{ W CW}$	$\Phi$	—	0.502	—	°
Average Group Delay @ $P_{out} = 100\text{ W CW}$ , $f = 1960\text{ MHz}$	Delay	—	2.57	—	ns
Part-to-Part Insertion Phase Variation @ $P_{out} = 100\text{ W CW}$ , $f = 1960\text{ MHz}$ , Six Sigma Window	$\Delta\Phi$	—	63.65	—	°
Gain Variation over Temperature (-30°C to +85°C)	$\Delta G$	—	0.048	—	dB/°C
Output Power Variation over Temperature (-30°C to +85°C)	$\Delta P_{1dB}$	—	0.004	—	dBm/°C



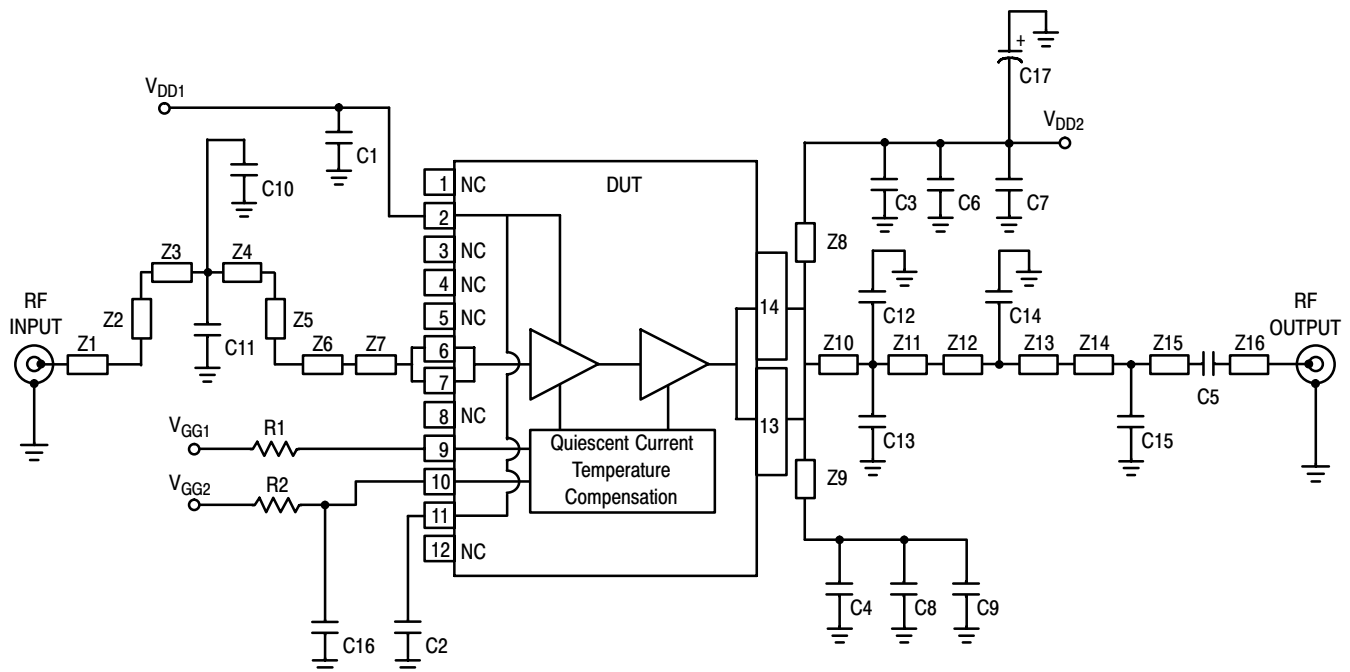

Z1	0.083" x 0.505" Microstrip	Z11	0.880" x 0.256" Microstrip
Z2, Z5	0.083" x 0.552" Microstrip	Z12	0.215" x 0.138" Microstrip
Z3	0.083" x 0.252" Microstrip	Z13	0.215" x 0.252" Microstrip
Z4	0.083" x 0.174" Microstrip	Z14	0.083" x 0.298" Microstrip
Z6	0.083" x 1.261" Microstrip	Z15	0.083" x 0.810" Microstrip
Z7	0.060" x 0.126" Microstrip	Z16	0.083" x 0.250" Microstrip
Z8, Z9	0.080" x 1.569" Microstrip	PCB	Arlon AD250, 0.030", $\epsilon_r = 2.5$
Z10	0.880" x 0.224" Microstrip		

Figure 3. MW7IC18100NR1(GNR1)(NBR1) Test Circuit Schematic — 1900 MHz

Table 6. MW7IC18100NR1(GNR1)(NBR1) Test Circuit Component Designations and Values — 1900 MHz

Part	Description	Part Number	Manufacturer
C1, C2, C3, C4, C5	6.8 pF Chip Capacitors	ATC100B6R8BT500XT	ATC
C6, C7, C8, C9	10 $\mu$ F, 50 V Chip Capacitors	GRM55DR61H106KA88L	Murata
C10, C11	0.2 pF Chip Capacitors	ATC100B0R2BT500XT	ATC
C12, C13	0.5 pF Chip Capacitors	ATC100B0R5BT500XT	ATC
C14	0.8 pF Chip Capacitor	ATC100B0R8BT500XT	ATC
C15	1.5 pF Chip Capacitor	ATC100B1R5BT500XT	ATC
C16	2.2 $\mu$ F, 16 V Chip Capacitor	C1206C225K4RAC	Kemet
C17	470 $\mu$ F, 63 V Electrolytic Capacitor, Radial	477KXM063M	Illinois Capacitor
R1, R2	10 K $\Omega$ , 1/4 W Chip Resistors	CRCW12061001FKTA	Vishay



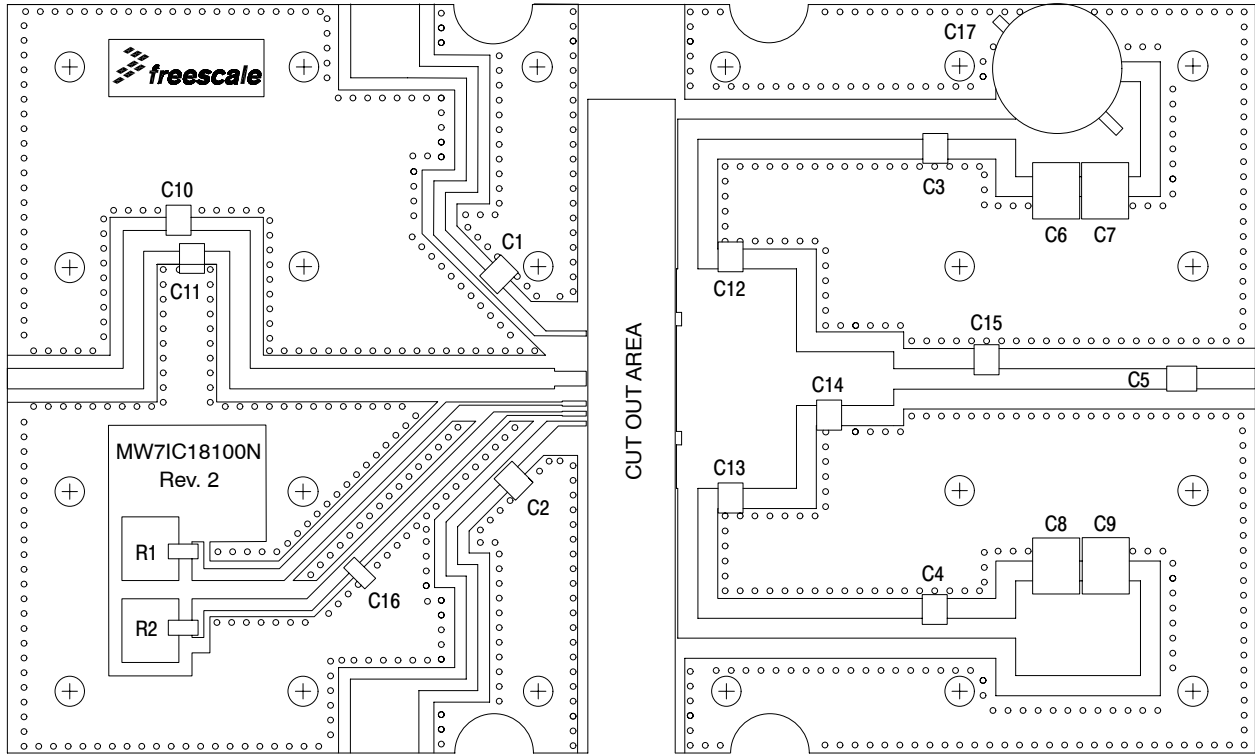

Figure 4. MW7IC18100NR1( GNR1)( NBR1) Test Circuit Component Layout — 1900 MHz



### TYPICAL CHARACTERISTICS — 1900 MHz

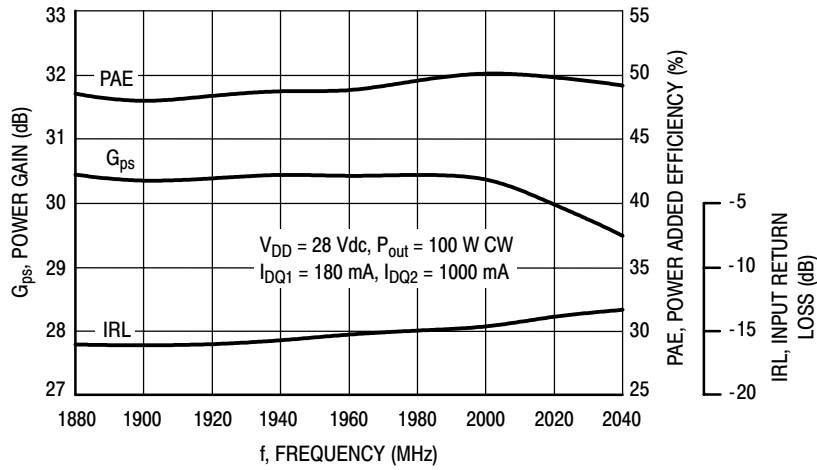

Figure 5. Power Gain, Input Return Loss and Power Added Efficiency versus Frequency @  $P_{out} = 100$  Watts CW

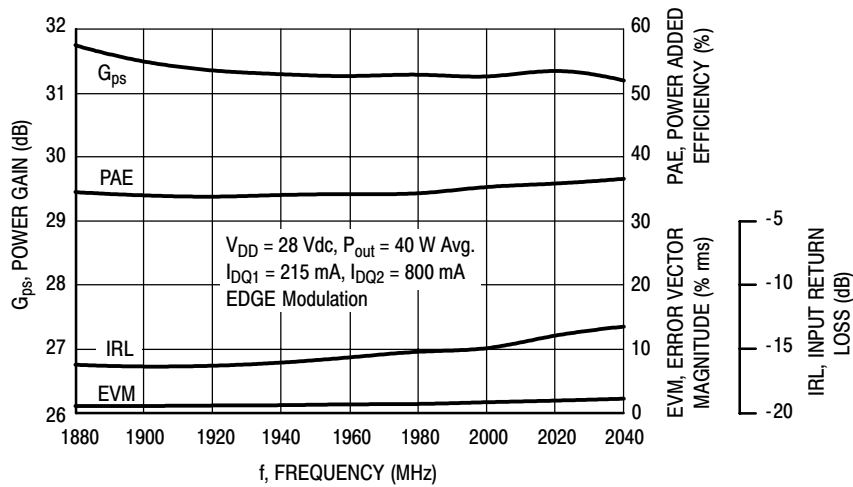

Figure 6. Power Gain, Input Return Loss, EVM and Power Added Efficiency versus Frequency @  $P_{out} = 40$  Watts Avg.

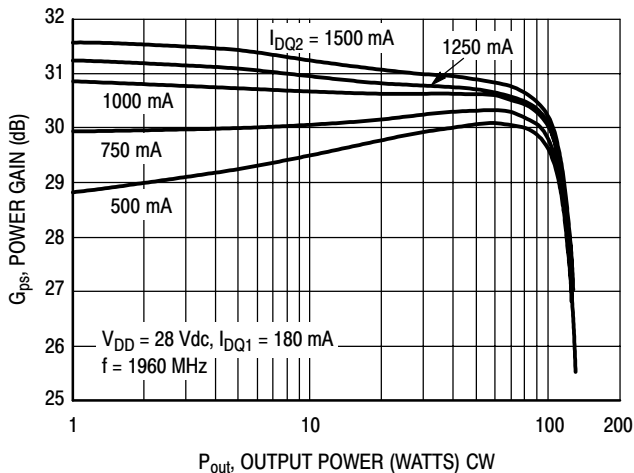

Figure 7. Two-Tone Power Gain versus Output Power @  $I_{DQ1} = 180$  mA

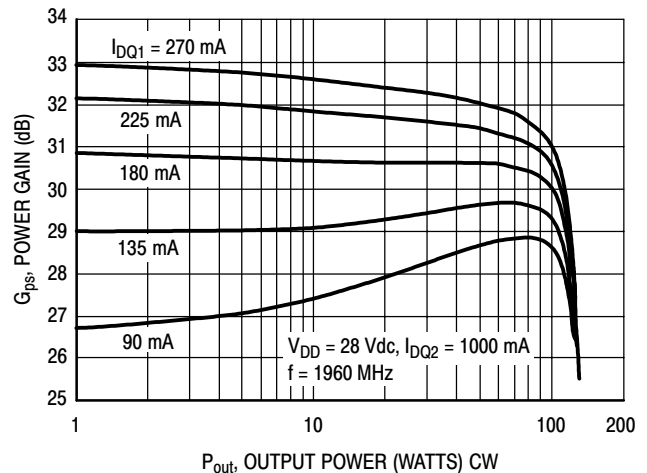
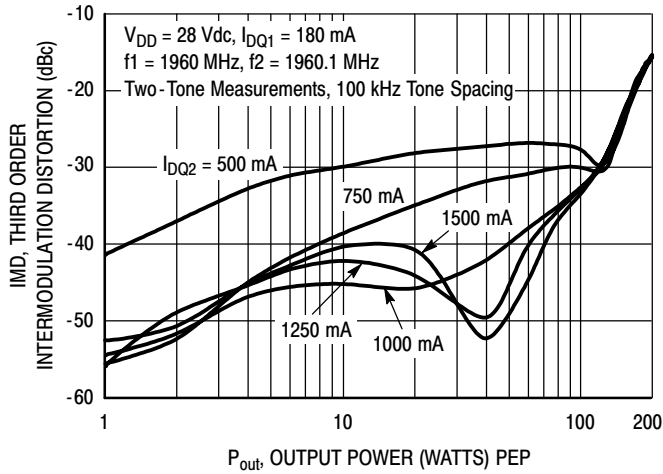

Figure 8. Two-Tone Power Gain versus Output Power @  $I_{DQ2} = 1000$  mA



## TYPICAL CHARACTERISTICS — 1900 MHz



**Figure 9. Third Order Intermodulation Distortion versus Output Power @  $I_{DQ1} = 180$  mA**

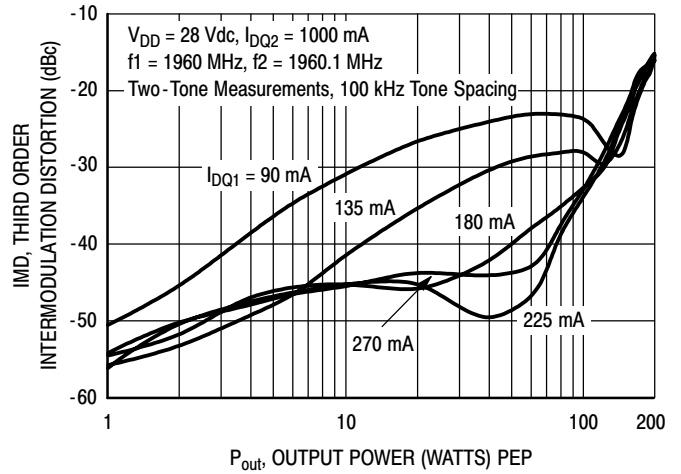

**Figure 10. Third Order Intermodulation Distortion versus Output Power @  $I_{DQ2} = 1000$  mA**

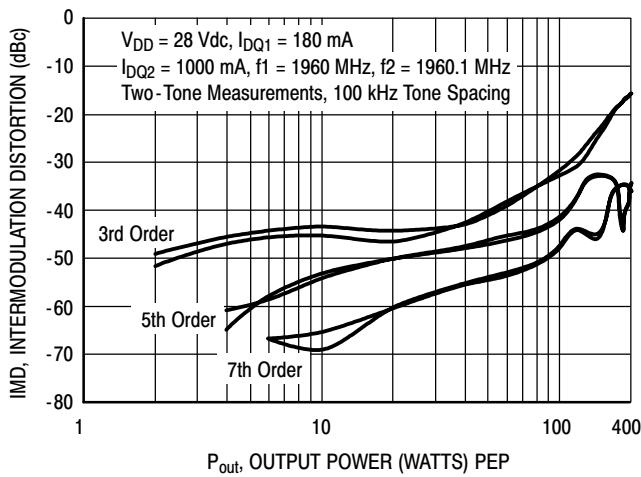

**Figure 11. Intermodulation Distortion Products versus Output Power**

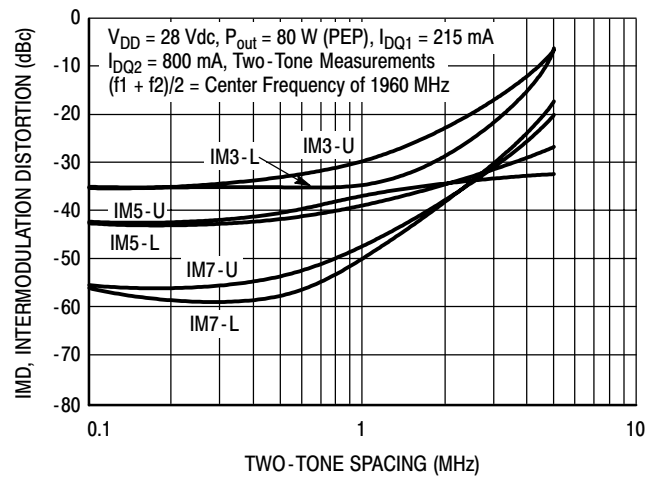

**Figure 12. Intermodulation Distortion Products versus Tone Spacing**

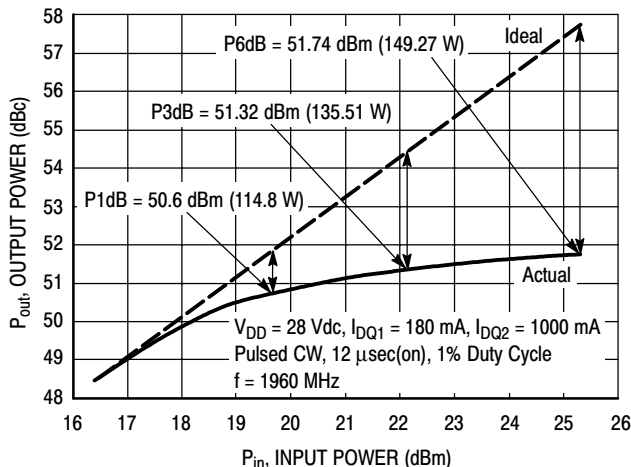

**Figure 13. Pulsed CW Output Power versus Input Power**

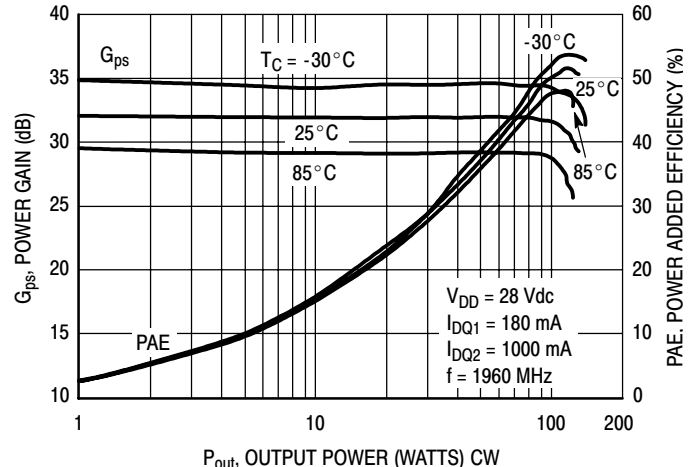

**Figure 14. Power Gain and Power Added Efficiency versus Output Power**



## TYPICAL CHARACTERISTICS — 1900 MHz

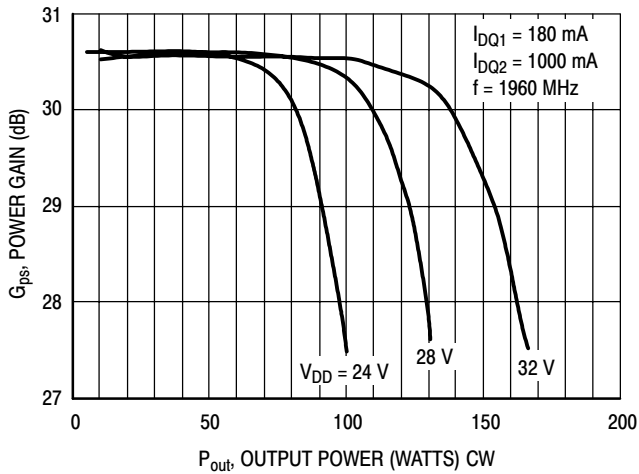

Figure 15. Power Gain versus Output Power

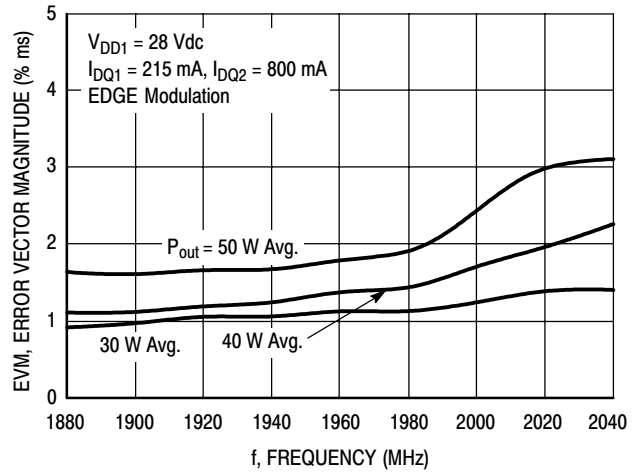

Figure 16. EVM versus Frequency

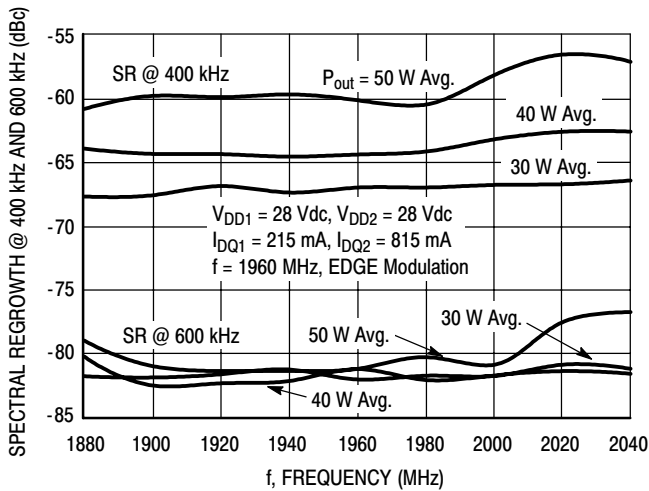

Figure 17. Spectral Regrowth at 400 kHz and 600 kHz versus Frequency

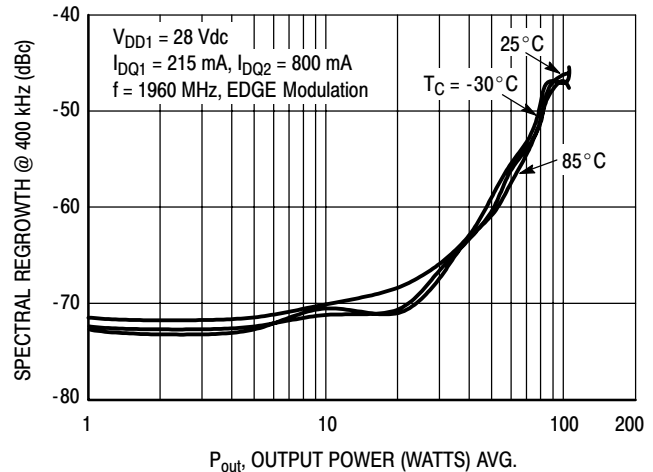

Figure 18. Spectral Regrowth at 400 kHz versus Output Power

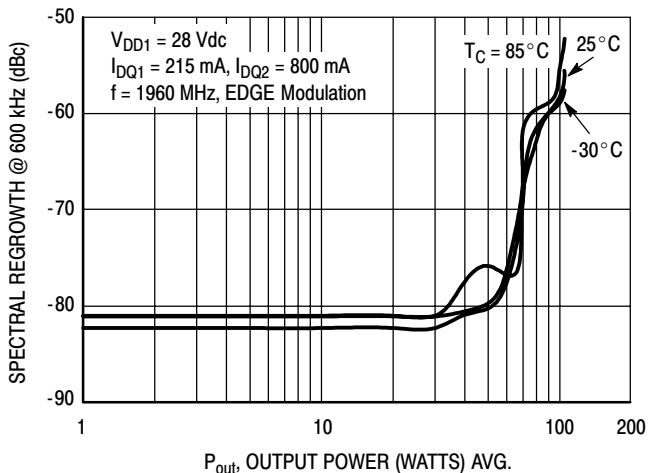

Figure 19. Spectral Regrowth at 600 kHz versus Output Power

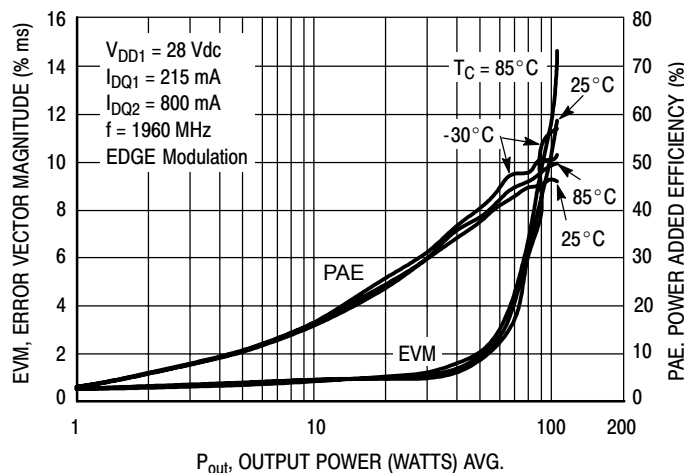

Figure 20. EVM and Power Added Efficiency versus Output Power





## TYPICAL CHARACTERISTICS — 1900 MHz

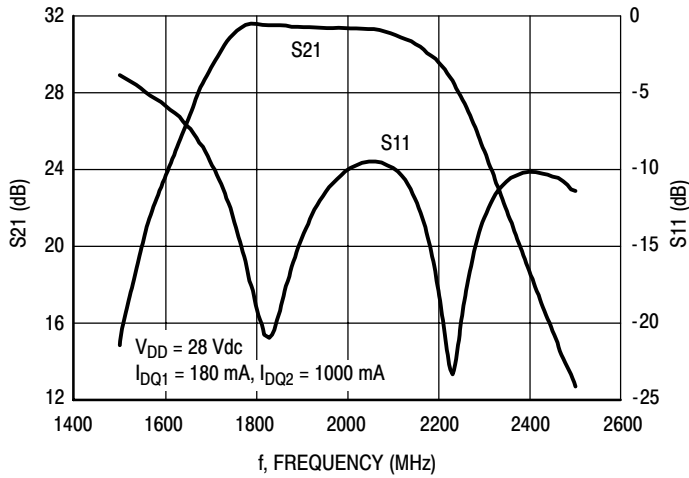

Figure 21. Broadband Frequency Response

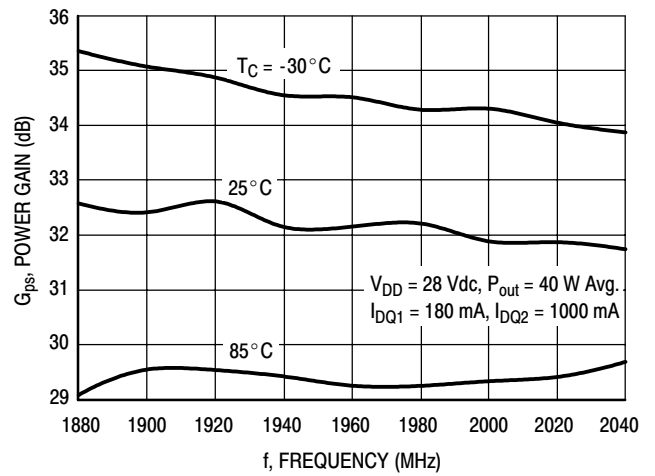
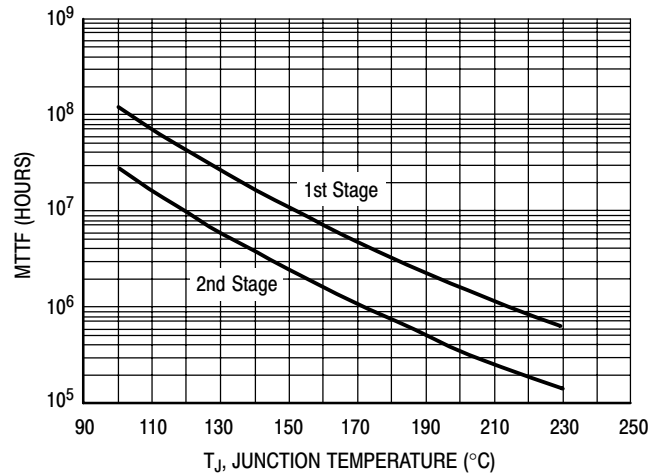

Figure 22. Power Gain versus Frequency



This above graph displays calculated MTTF in hours when the device is operated at  $V_{DD} = 28 \text{ Vdc}$ ,  $P_{out} = 100 \text{ W CW}$ , and  $\text{PAE} = 48\%$ .

MTTF calculator available at <http://www.freescale.com/rf>. Select Tools/Software/Application Software/Calculators to access the MTTF calculators by product.

Figure 23. MTTF versus Junction Temperature



### GSM TEST SIGNAL

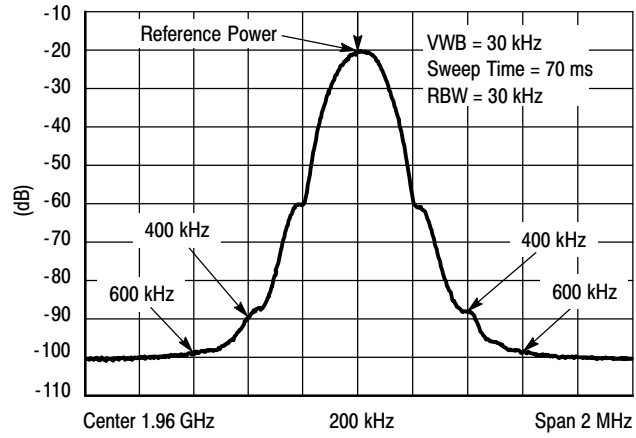
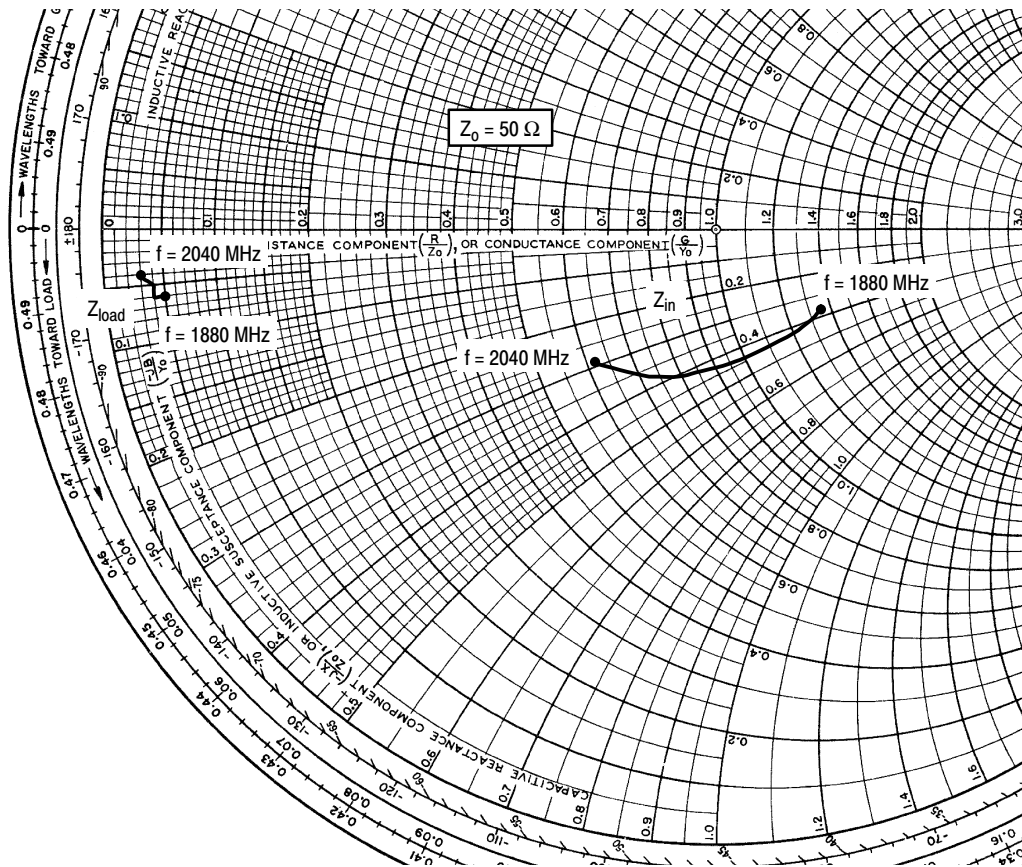

Figure 24. EDGE Spectrum





$V_{DD1} = V_{DD2} = 28 \text{ Vdc}$ ,  $I_{DQ1} = 180 \text{ mA}$ ,  $I_{DQ2} = 1000 \text{ mA}$ ,  $P_{out} = 100 \text{ W CW}$

f MHz	$Z_{in}$ $\Omega$	$Z_{load}$ $\Omega$
1880	67.48 - j17.89	2.324 - j3.239
1900	60.03 - j20.86	2.234 - j3.105
1920	53.65 - j21.94	2.135 - j2.965
1940	48.13 - j21.94	2.037 - j2.818
1960	43.52 - j21.22	1.936 - j2.666
1980	39.60 - j20.00	1.851 - j2.509
2000	36.14 - j18.52	1.765 - j2.355
2020	33.19 - j16.57	1.669 - j2.193
2040	30.96 - j14.58	1.559 - j2.012

$Z_{in}$  = Device input impedance as measured from gate to ground.

$Z_{load}$  = Test circuit impedance as measured from drain to ground.

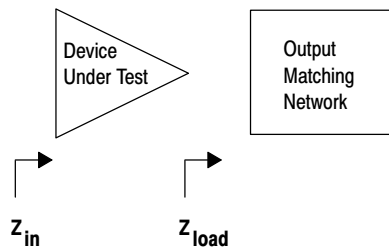

Figure 25. Series Equivalent Input and Load Impedance — 1900 MHz

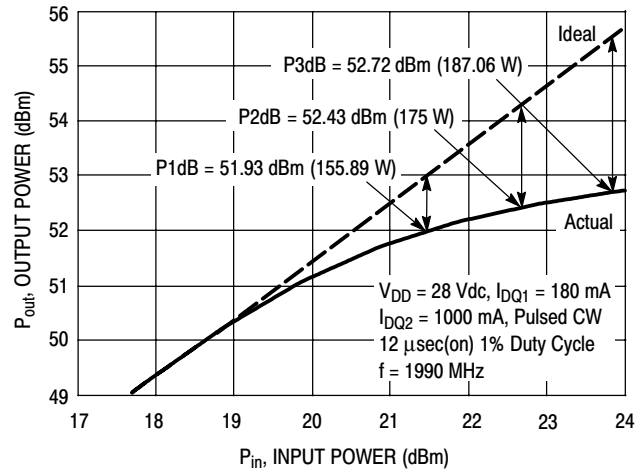

**Table 7. Common Source S-Parameters ( $V_{DD} = 28\text{ V}$ ,  $I_{DQ1} = 180\text{ mA}$ ,  $I_{DQ2} = 1000\text{ mA}$ ,  $T_C = 25^\circ\text{C}$ , 50 Ohm System)**

f MHz	S <sub>11</sub>		S <sub>21</sub>		S <sub>12</sub>		S <sub>22</sub>	
	S <sub>11</sub>	∠ φ	S <sub>21</sub>	∠ φ	S <sub>12</sub>	∠ φ	S <sub>22</sub>	∠ φ
1500	0.612	118.5	6.369	69.06	0.002	102.9	0.615	47.74
1550	0.557	104.3	11.42	18.29	0.003	85.09	0.666	-41.54
1600	0.491	88.33	16.92	-34.34	0.005	59.06	0.844	-113.4
1650	0.410	70.24	23.21	-84.03	0.005	28.40	0.931	-163.4
1700	0.313	48.99	30.49	-135.7	0.006	7.983	0.887	155.6
1750	0.216	21.99	32.64	168.8	0.007	-15.63	0.700	120.3
1800	0.131	-22.83	32.93	114.0	0.006	-35.27	0.475	95.71
1850	0.117	-95.13	32.62	65.01	0.006	-53.22	0.332	82.10
1900	0.185	-146.3	32.58	20.45	0.006	-77.03	0.252	68.30
1950	0.253	-177.3	32.45	-22.53	0.007	-98.93	0.165	47.02
2000	0.303	160.4	32.41	-65.29	0.007	-108.4	0.052	8.742
2050	0.328	139.5	32.33	-108.6	0.006	-127.3	0.070	-154.8
2100	0.331	117.9	32.50	-152.7	0.008	-145.8	0.161	179.9
2150	0.273	91.65	32.84	160.2	0.008	-169.1	0.257	165.7
2200	0.141	64.27	32.52	109.2	0.008	162.7	0.424	150.3
2250	0.050	172.7	28.92	56.72	0.009	138.3	0.641	123.4
2300	0.194	163.4	21.30	8.112	0.007	112.6	0.804	91.99
2350	0.270	139.7	14.62	-34.53	0.007	97.74	0.879	62.03
2400	0.288	118.9	9.878	-72.70	0.007	84.37	0.910	34.57
2450	0.274	100.6	6.771	-107.5	0.007	70.79	0.911	8.878
2500	0.236	83.35	4.579	-141.3	0.007	55.31	0.903	-16.73



## ALTERNATIVE PEAK TUNE LOAD PULL CHARACTERISTICS — 1900 MHz



NOTE: Load Pull Test Fixture Tuned for Peak Output Power @ 28 V

Test Impedances per Compression Level

	$Z_{source}$ $\Omega$	$Z_{load}$ $\Omega$
P3dB	40.2 - j30.91	0.96 - j3.14

**Figure 26. Pulsed CW Output Power versus Input Power @ 28 V**



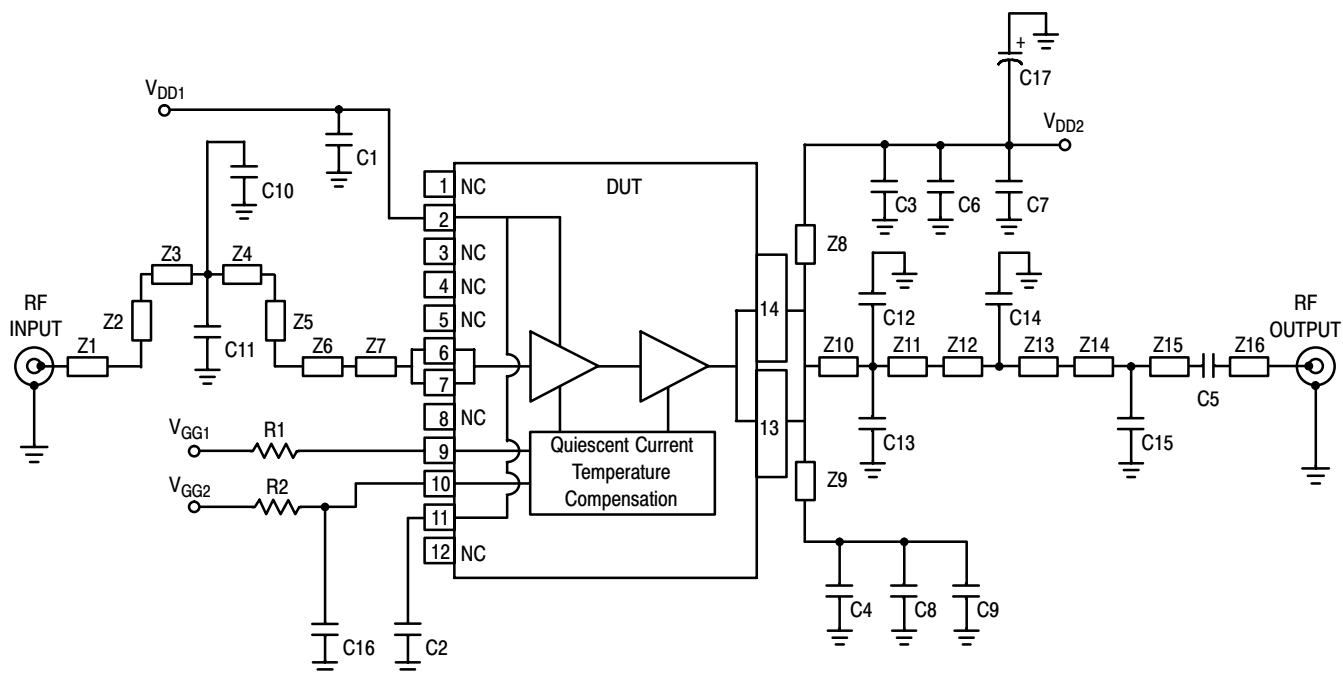

Z1	0.083" x 0.505" Microstrip	Z11	0.880" x 0.256" Microstrip
Z2, Z5	0.083" x 0.552" Microstrip	Z12	0.215" x 0.138" Microstrip
Z3	0.083" x 0.252" Microstrip	Z13	0.215" x 0.252" Microstrip
Z4	0.083" x 0.174" Microstrip	Z14	0.083" x 0.298" Microstrip
Z6	0.083" x 1.261" Microstrip	Z15	0.083" x 0.810" Microstrip
Z7	0.060" x 0.126" Microstrip	Z16	0.083" x 0.250" Microstrip
Z8, Z9	0.080" x 1.569" Microstrip	PCB	Arlon AD250, 0.030", $\epsilon_r = 2.5$
Z10	0.880" x 0.224" Microstrip		

Figure 27. MW7IC18100NR1(GNR1)(NBR1) Test Circuit Schematic — 1800 MHz

Table 8. MW7IC18100NR1(GNR1)(NBR1) Test Circuit Component Designations and Values — 1800 MHz

Part	Description	Part Number	Manufacturer
C1, C2, C3, C4, C5	6.8 pF Chip Capacitors	ATC100B6R8BT500XT	ATC
C6, C7, C8, C9	10 $\mu$ F, 50 V Chip Capacitors	GRM55DR61H106KA88L	Murata
C10, C11	0.2 pF Chip Capacitors	ATC100B0R2BT500XT	ATC
C12, C13	0.8 pF Chip Capacitors	ATC100B0R8BT500XT	ATC
C14	1.2 pF Chip Capacitor	ATC100B1R2BT500XT	ATC
C15	1.0 pF Chip Capacitor	ATC100B1R0BT500XT	ATC
C16	2.2 $\mu$ F, 16 V Chip Capacitor	C1206C225K4RAC	Kemet
C17	470 $\mu$ F, 63 V Electrolytic Capacitor, Radial	477KXM063M	Illinois Capacitor
R1, R2	10 K $\Omega$ , 1/4 W Chip Resistors	CRCW12061001FKTA	Vishay



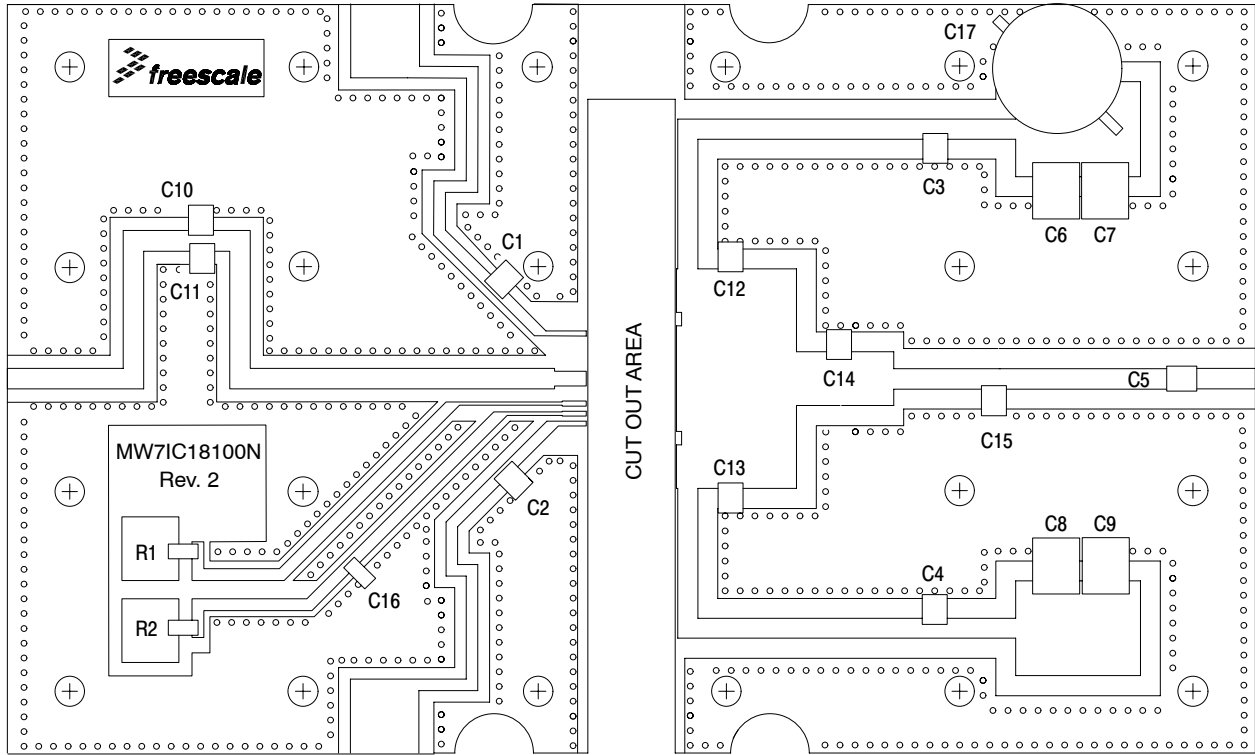

**Figure 28. MW7IC18100NR1(GNR1)(NBR1) Test Circuit Component Layout — 1800 MHz**



### TYPICAL CHARACTERISTICS — 1800 MHz

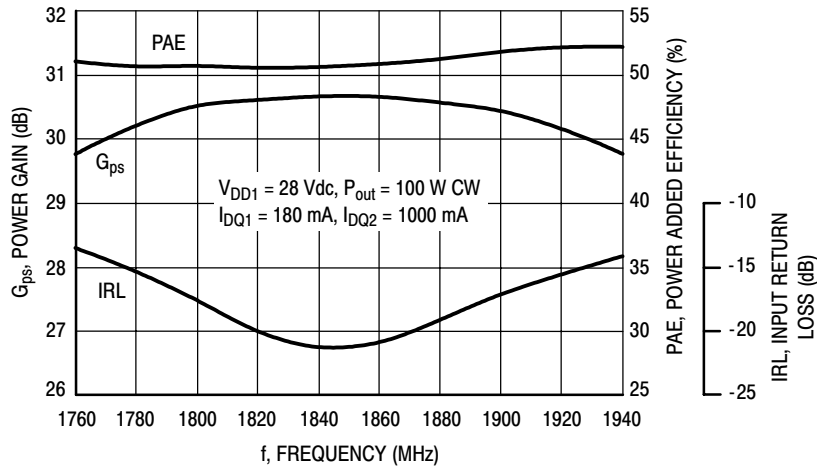

Figure 29. Power Gain, Input Return Loss and Power Added Efficiency versus Frequency @  $P_{out} = 100$  Watts CW

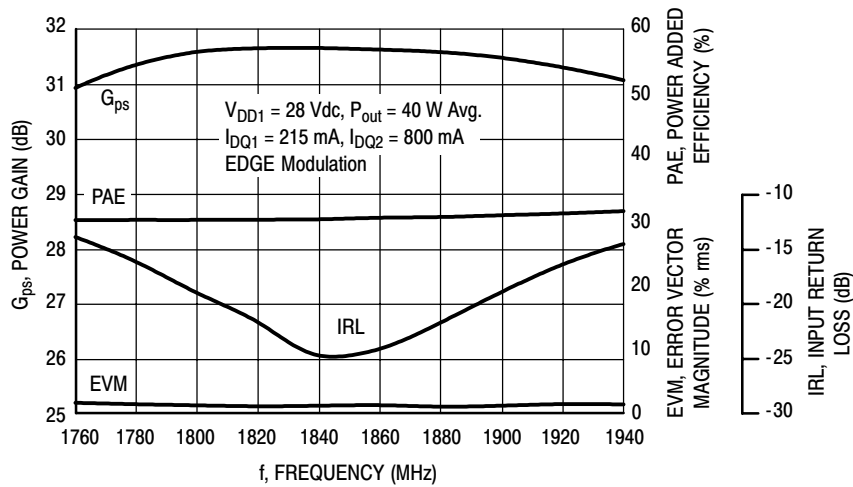

Figure 30. Power Gain, Input Return Loss, EVM and Power Added Efficiency versus Frequency @  $P_{out} = 40$  Watts Avg.

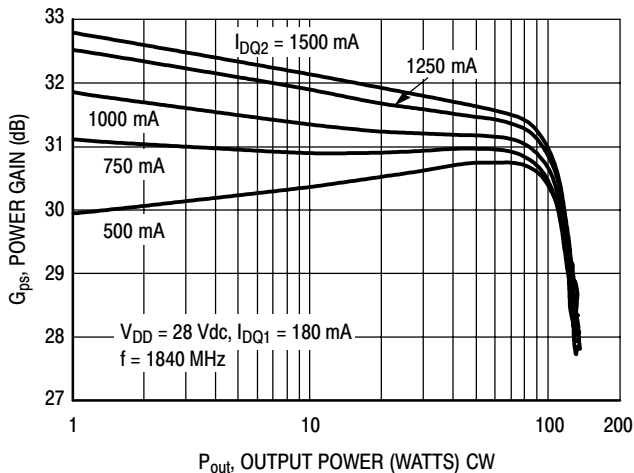

Figure 31. Two-Tone Power Gain versus Output Power @  $I_{DQ1} = 180$  mA

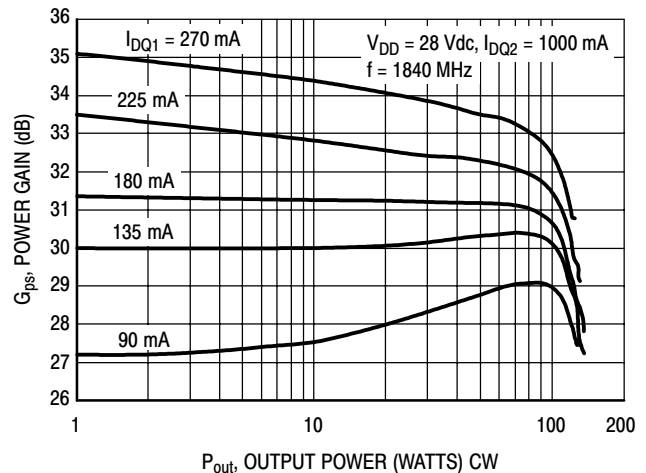
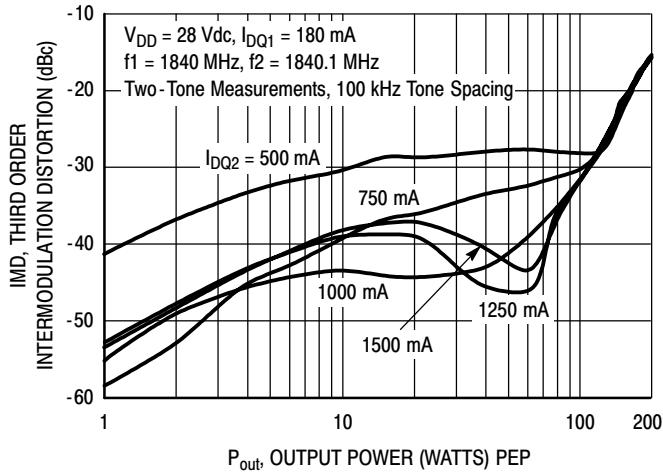

Figure 32. Two-Tone Power Gain versus Output Power @  $I_{DQ2} = 1000$  mA





## TYPICAL CHARACTERISTICS — 1800 MHz



**Figure 33. Third Order Intermodulation Distortion versus Output Power @  $I_{DQ1} = 180$  mA**

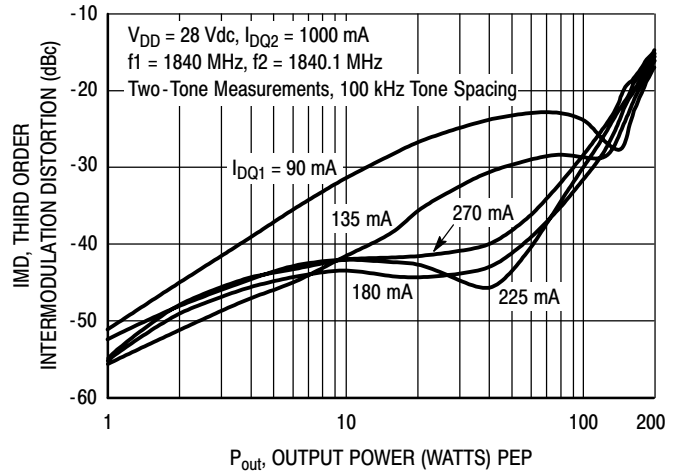

**Figure 34. Third Order Intermodulation Distortion versus Output Power @  $I_{DQ2} = 1000$  mA**

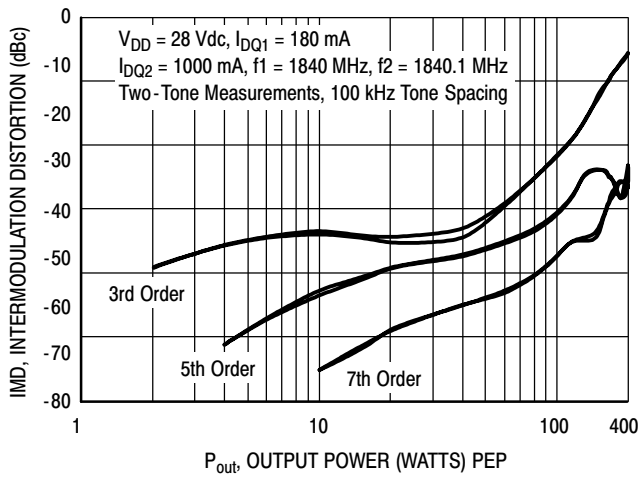

**Figure 35. Intermodulation Distortion Products versus Output Power**

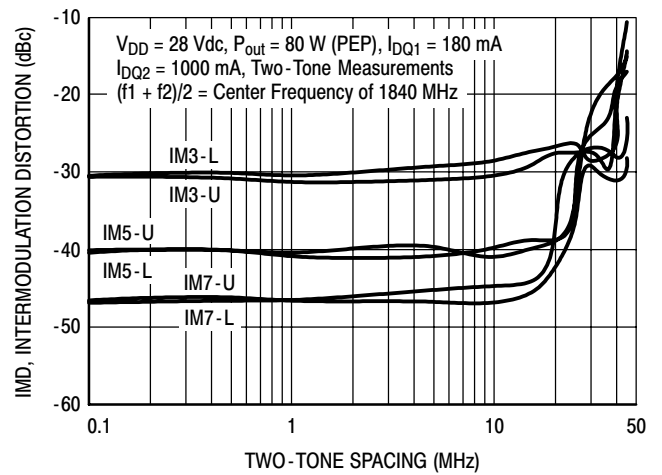

**Figure 36. Intermodulation Distortion Products versus Tone Spacing**

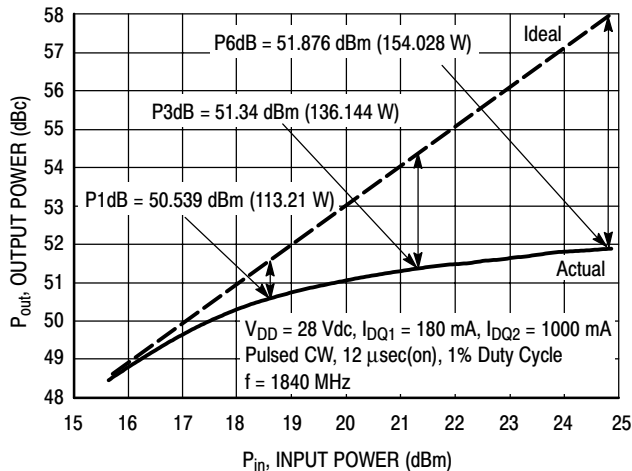

**Figure 37. Pulsed CW Output Power versus Input Power**

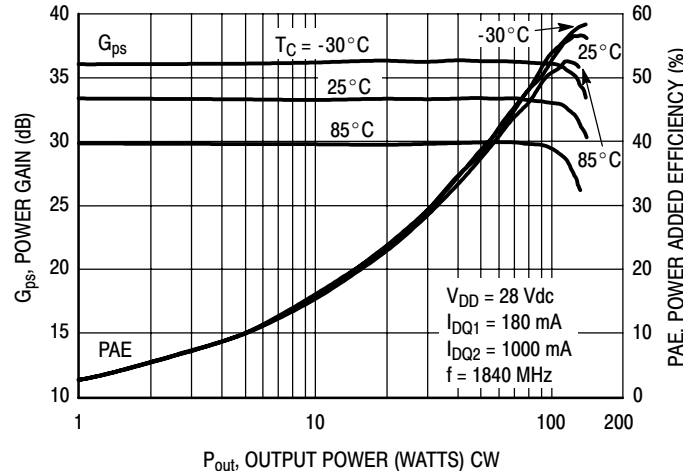

**Figure 38. Power Gain and Power Added Efficiency versus Output Power**



## TYPICAL CHARACTERISTICS — 1800 MHz

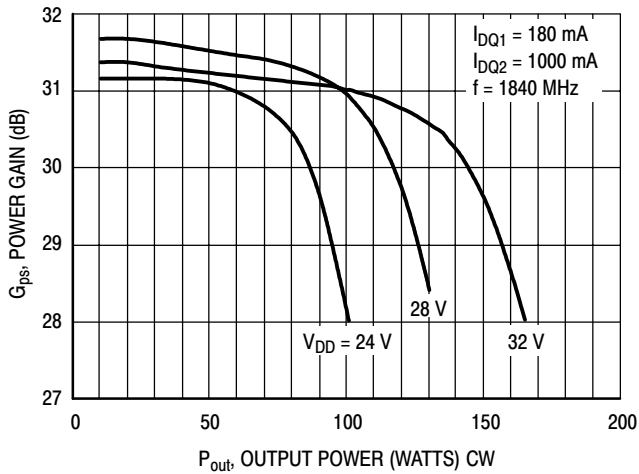

Figure 39. Power Gain versus Output Power

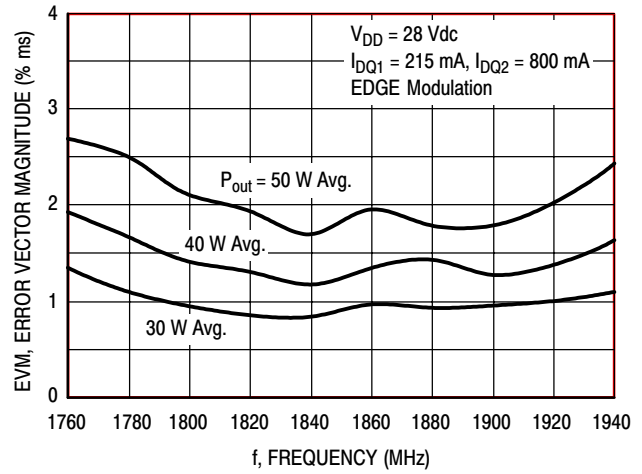

Figure 40. EVM versus Frequency

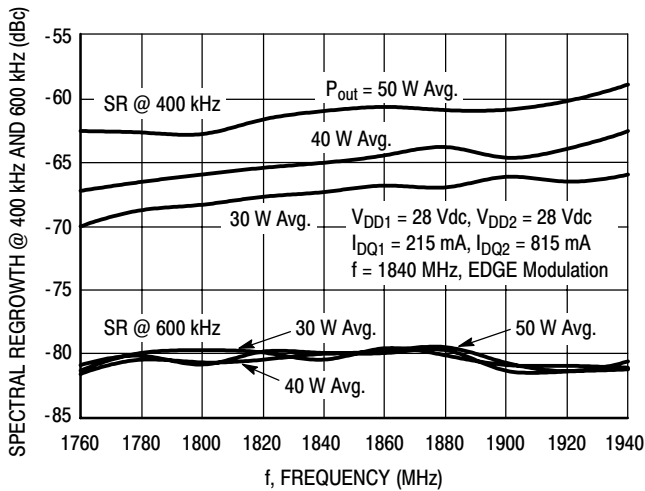

Figure 41. Spectral Regrowth at 400 kHz and 600 kHz versus Frequency

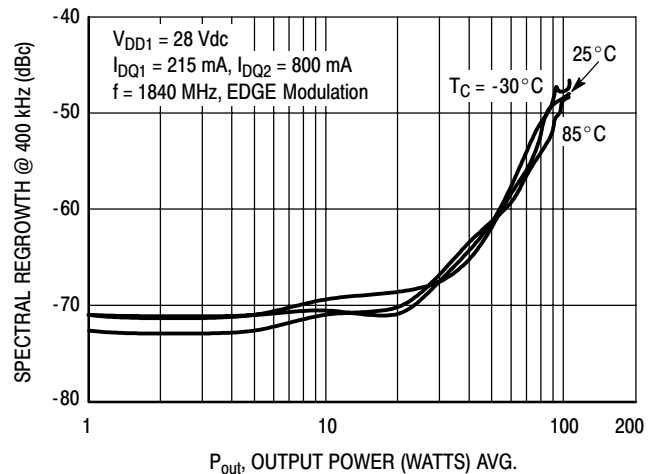

Figure 42. Spectral Regrowth at 400 kHz versus Output Power

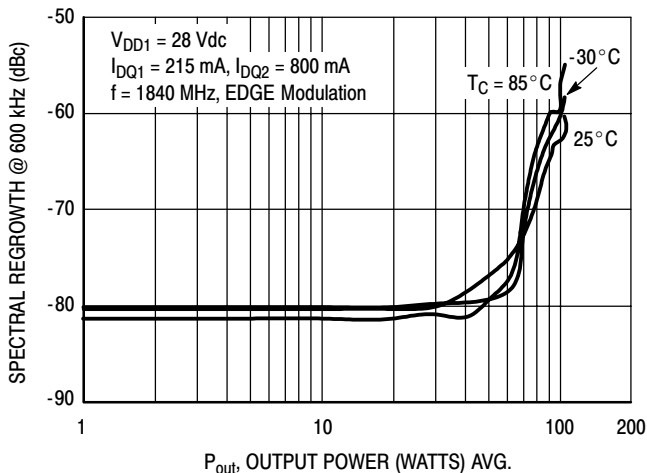

Figure 43. Spectral Regrowth at 600 kHz versus Output Power

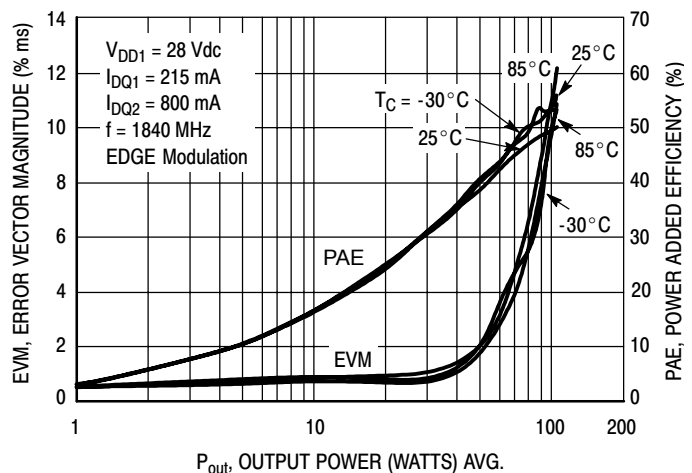

Figure 44. EVM and Power Added Efficiency versus Output Power



### TYPICAL CHARACTERISTICS — 1800 MHz

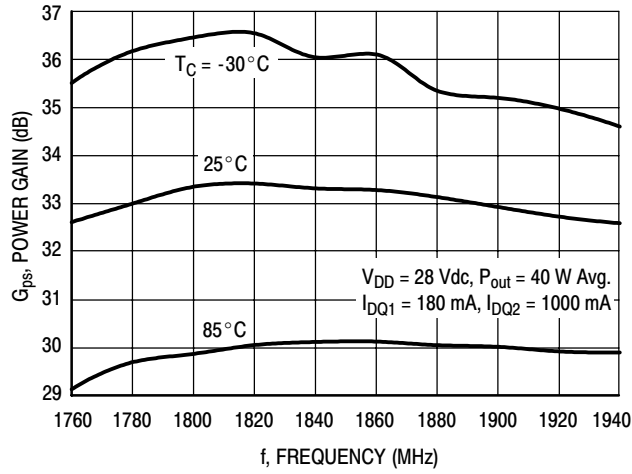
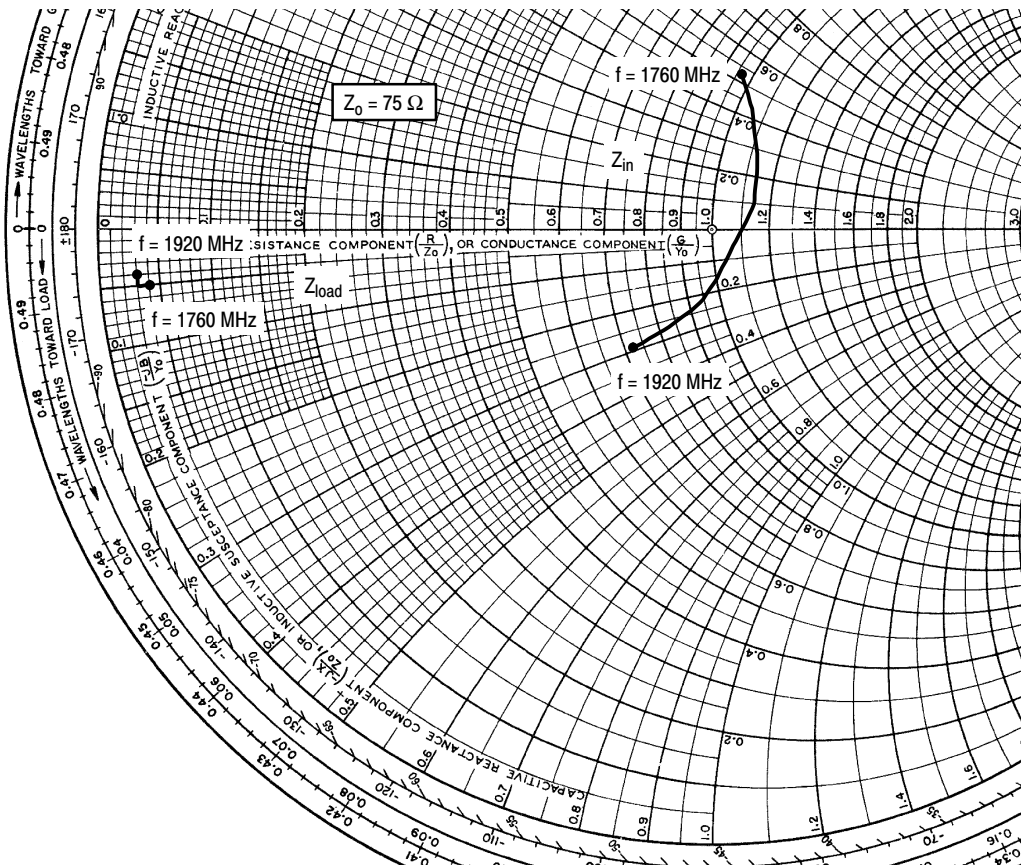

Figure 45. Power Gain versus Frequency





$V_{DD1} = V_{DD2} = 28 \text{ Vdc}$ ,  $I_{DQ1} = 180 \text{ mA}$ ,  $I_{DQ2} = 1000 \text{ mA}$ ,  $P_{out} = 100 \text{ W CW}$

f MHz	$Z_{in}$ $\Omega$	$Z_{load}$ $\Omega$
1760	$71.78 + j40.05$	$2.983 - j3.974$
1780	$79.83 + j31.13$	$2.872 - j3.861$
1800	$84.35 + j19.44$	$2.757 - j3.745$
1820	$84.75 + j7.234$	$2.636 - j3.639$
1840	$81.21 - j4.076$	$2.535 - j3.506$
1860	$74.76 - j12.32$	$2.434 - j3.376$
1880	$67.49 - j17.89$	$2.324 - j3.239$
1900	$60.03 - j20.86$	$2.234 - j3.105$
1920	$53.65 - j21.94$	$2.135 - j2.965$

$Z_{in}$  = Device input impedance as measured from gate to ground.

$Z_{load}$  = Test circuit impedance as measured from drain to ground.

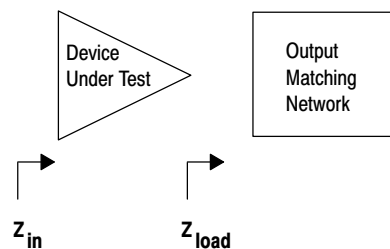
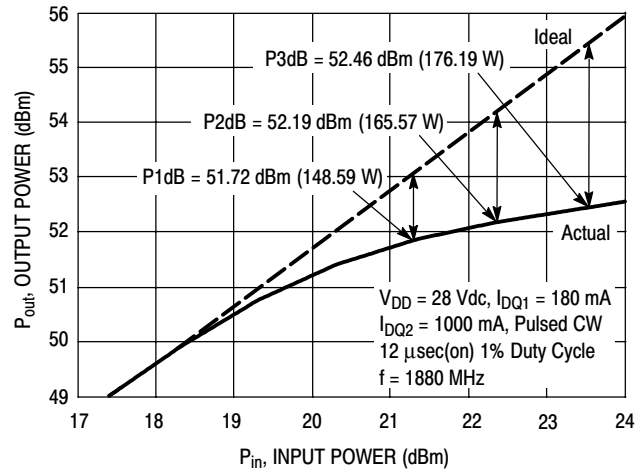

Figure 46. Series Equivalent Input and Load Impedance — 1800 MHz



## ALTERNATIVE PEAK TUNE LOAD PULL CHARACTERISTICS — 1800 MHz



NOTE: Load Pull Test Fixture Tuned for Peak Output Power @ 28 V

Test Impedances per Compression Level

	$Z_{source}$ $\Omega$	$Z_{load}$ $\Omega$
P3dB	83.04 - j2.44	1.36 - j3.19

**Figure 47. Pulsed CW Output Power versus Input Power @ 28 V**



**PACKAGE DIMENSIONS**

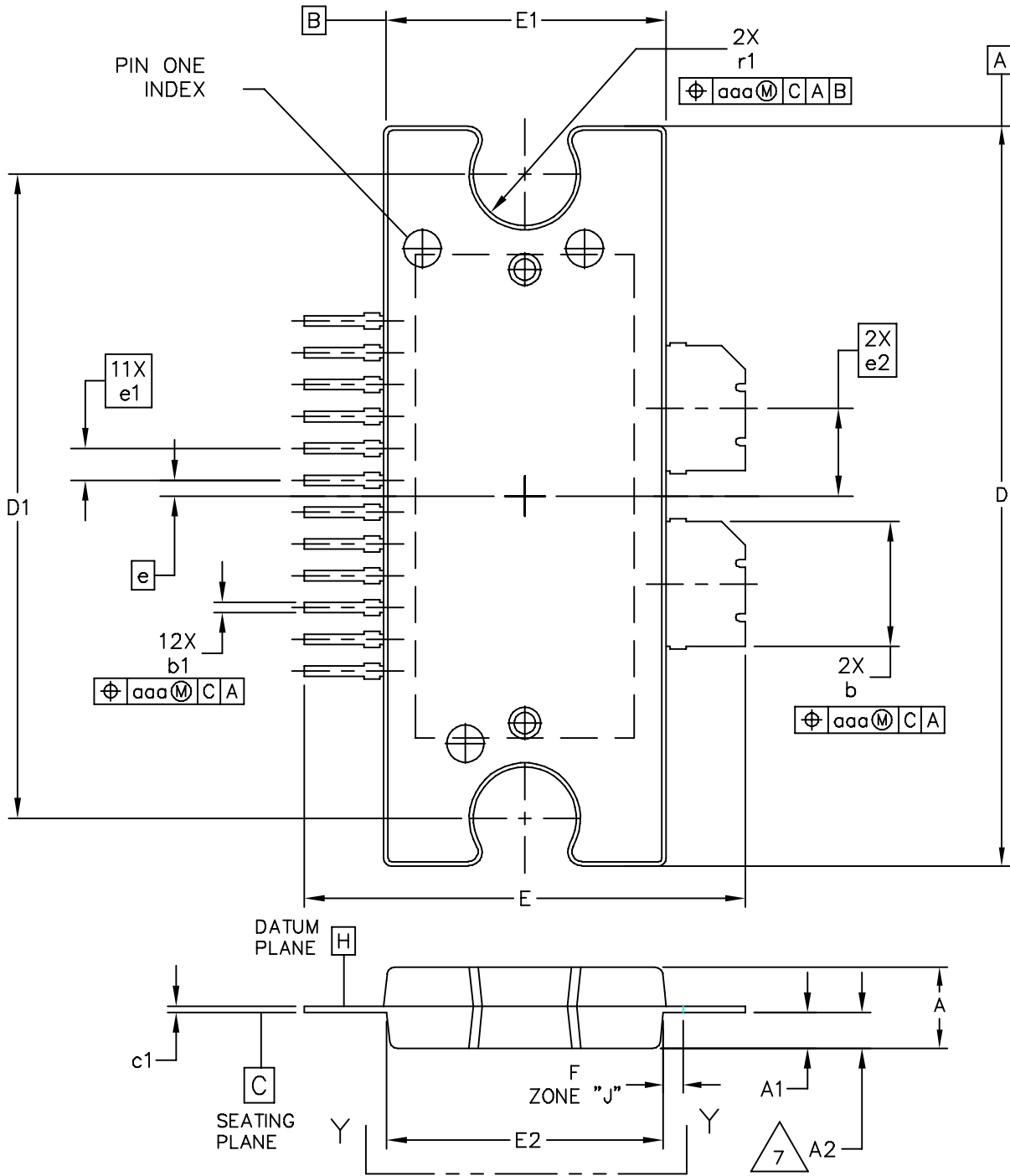

© FREESCALE SEMICONDUCTOR, INC. ALL RIGHTS RESERVED.		<b>MECHANICAL OUTLINE</b>		PRINT VERSION NOT TO SCALE	
TITLE: TO-272 WIDE BODY 14 LEAD		DOCUMENT NO: 98ASA10649D		REV: 0	
		CASE NUMBER: 1617-01		23 NOV 2005	
		STANDARD: NON-JEDEC			



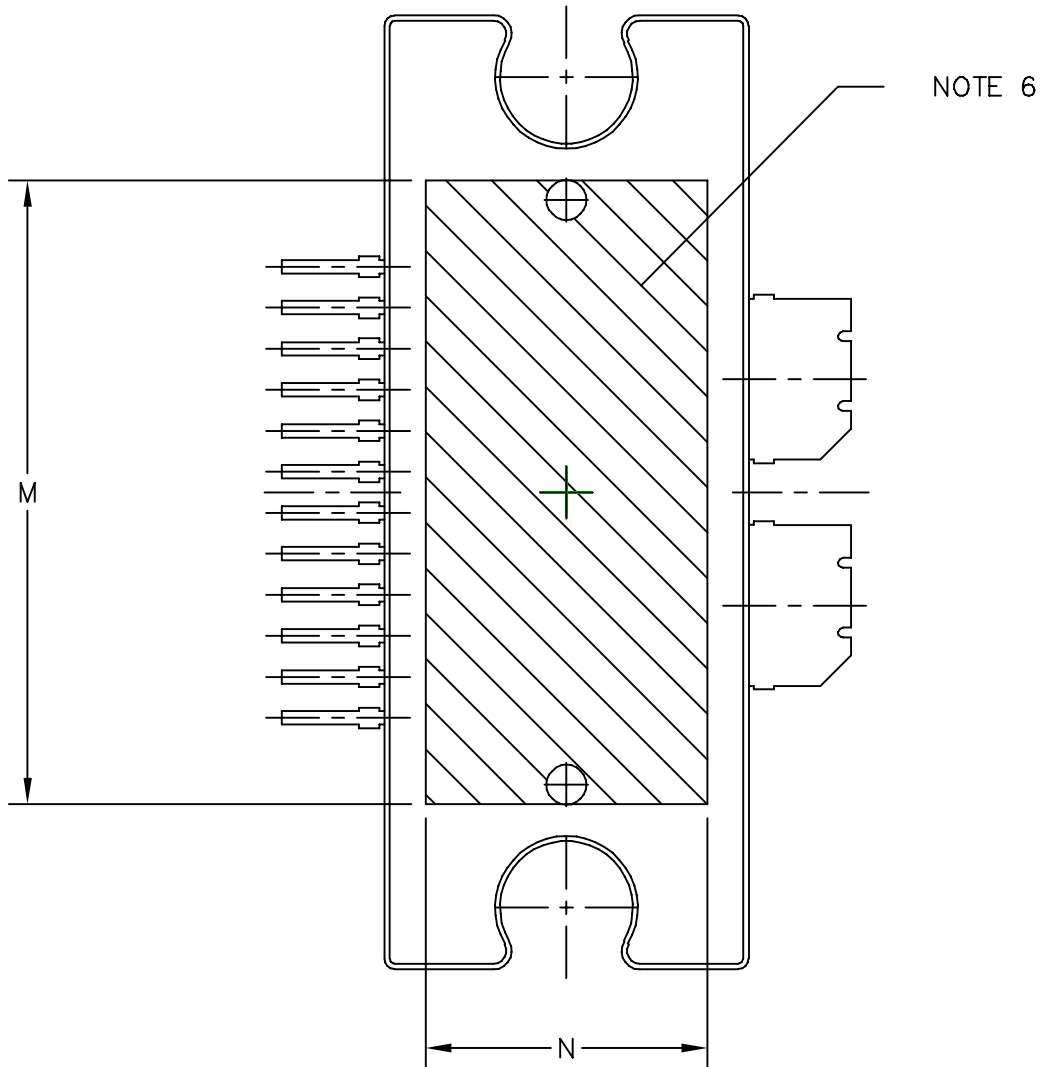

VIEW Y-Y

© FREESCALE SEMICONDUCTOR, INC. ALL RIGHTS RESERVED.	<b>MECHANICAL OUTLINE</b>	PRINT VERSION NOT TO SCALE	
TITLE: TO-272 WIDE BODY 14 LEAD	DOCUMENT NO: 98ASA10649D	REV: 0	
	CASE NUMBER: 1617-01	23 NOV 2005	
	STANDARD: NON-JEDEC		



NOTES:

1. CONTROLLING DIMENSION: INCH
2. INTERPRET DIMENSIONS AND TOLERANCES PER ASME Y14.5M-1994.
3. DATUM PLANE -H- IS LOCATED AT THE TOP OF LEAD AND IS COINCIDENT WITH THE LEAD WHERE THE LEAD EXITS THE PLASTIC BODY AT THE TOP OF THE PARTING LINE.
4. DIMENSIONS "D" AND "E1" DO NOT INCLUDE MOLD PROTRUSION. ALLOWABLE PROTRUSION IS .006 (0.15) PER SIDE. DIMENSIONS "D" AND "E1" DO INCLUDE MOLD MISMATCH AND ARE DETERMINED AT DATUM PLANE -H-.
5. DIMENSIONS "b" AND "b1" DO NOT INCLUDE DAMBAR PROTRUSION. ALLOWABLE DAMBAR PROTRUSION SHALL BE .005 (0.13) TOTAL IN EXCESS OF THE "b" AND "b1" DIMENSIONS AT MAXIMUM MATERIAL CONDITION.
6. HATCHING REPRESENTS THE EXPOSED AREA OF THE HEAT SLUG.
7. DIM A2 APPLIES WITHIN ZONE "J" ONLY.

DIM	INCH		MILLIMETER		DIM	INCH		MILLIMETER	
	MIN	MAX	MIN	MAX		MIN	MAX	MIN	MAX
A	.100	.104	2.54	2.64	b	.154	.160	3.91	4.06
A1	.039	.043	0.96	1.12	b1	.010	.016	0.25	0.41
A2	.040	.042	1.02	1.07	c1	.007	.011	.18	.28
D	.928	.932	23.57	23.67	e	.020 BSC		0.51 BSC	
D1	.810 BSC		20.57 BSC		e1	.040 BSC		1.02 BSC	
E	.551	.559	14.00	14.20	e2	.1105 BSC		2.807 BSC	
E1	.353	.357	8.97	9.07	r1	.063	.068	1.6	1.73
E2	.346	.350	8.79	8.89					
F	.025 BSC		0.64 BSC		aaa	.004		.10	
M	.600	----	15.24	----					
N	.270	----	6.86	----					

© FREESCALE SEMICONDUCTOR, INC. ALL RIGHTS RESERVED.		<b>MECHANICAL OUTLINE</b>		PRINT VERSION NOT TO SCALE	
TITLE: TO-272 WIDE BODY 14 LEAD		DOCUMENT NO: 98ASA10649D		REV: 0	
		CASE NUMBER: 1617-01		23 NOV 2005	
		STANDARD: NON-JEDEC			







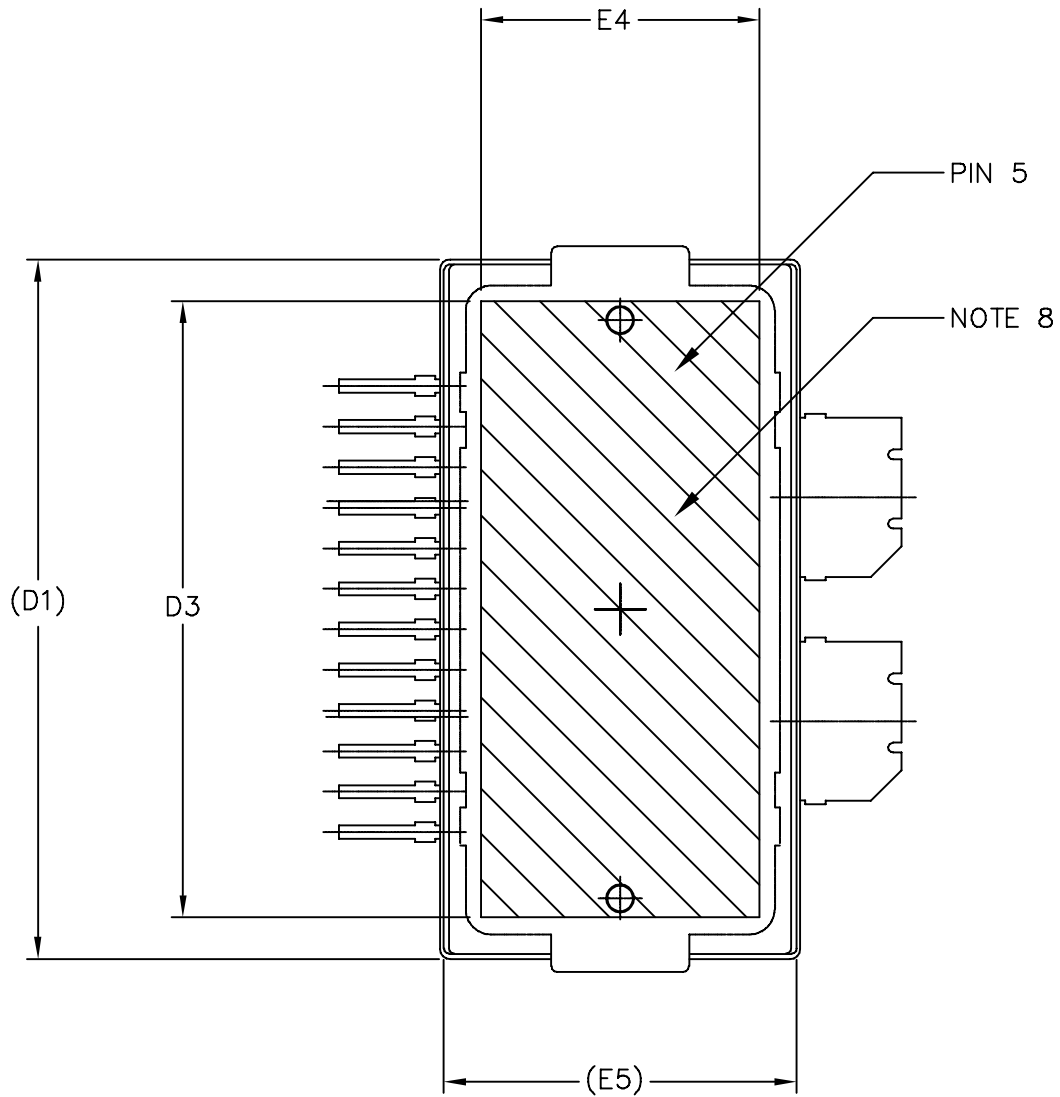

© FREESCALE SEMICONDUCTOR, INC. ALL RIGHTS RESERVED.	<b>MECHANICAL OUTLINE</b>	PRINT VERSION NOT TO SCALE	
TITLE: TO-270 WIDE BODY 14 LEAD	DOCUMENT NO: 98ASA10650D	REV: 0	
	CASE NUMBER: 1618-01	29 SEP 2005	
	STANDARD: NON-JEDEC		



NOTES:

1. CONTROLLING DIMENSION: INCH
2. INTERPRET DIMENSIONS AND TOLERANCES PER ASME Y14.5M-1994.
3. DATUM PLANE -H- IS LOCATED AT THE TOP OF LEAD AND IS COINCIDENT WITH THE LEAD WHERE THE LEAD EXITS THE PLASTIC BODY AT THE TOP OF THE PARTING LINE.
4. DIMENSIONS "D" AND "E1" DO NOT INCLUDE MOLD PROTRUSION. ALLOWABLE PROTRUSION IS .006 PER SIDE. DIMENSIONS "D" AND "E1" DO INCLUDE MOLD MISMATCH AND ARE DETERMINED AT DATUM PLANE -H-.
5. DIMENSIONS "b" AND "b1" DOES NOT INCLUDE DAMBAR PROTRUSION. ALLOWABLE DAMBAR PROTRUSION SHALL BE .005 TOTAL IN EXCESS OF THE "b" AND "b1" DIMENSION AT MAXIMUM MATERIAL CONDITION.
6. DATUMS -A- AND -B- TO BE DETERMINED AT DATUM PLANE -H-.
7. DIMENSION A2 APPLIES WITHIN ZONE "J" ONLY.
8. HATCHING REPRESENTS THE EXPOSED AREA OF THE HEAT SLUG.

DIM	INCH		MILLIMETER		DIM	INCH		MILLIMETER	
	MIN	MAX	MIN	MAX		MIN	MAX	MIN	MAX
A	.100	.104	2.54	2.64	F	.025 BSC		0.64 BSC	
A1	.039	.043	0.99	1.09	b	.154	.160	3.91	4.06
A2	.040	.042	1.02	1.07	b1	.010	.016	0.25	0.41
D	.712	.720	18.08	18.29	c1	.007	.011	.18	.28
D1	.688	.692	17.48	17.58	e	.020 BSC		0.51 BSC	
D2	.011	.019	0.28	0.48	e1	.040 BSC		1.02 BSC	
D3	.600	---	15.24	---	e2	.1105 BSC		2.807 BSC	
E	.551	.559	14	14.2					
E1	.353	.357	8.97	9.07	aaa	.004		.10	
E2	.132	.140	3.35	3.56					
E3	.124	.132	3.15	3.35					
E4	.270	---	6.86	---					
E5	.346	.350	8.79	8.89					
© FREESCALE SEMICONDUCTOR, INC. ALL RIGHTS RESERVED.			<b>MECHANICAL OUTLINE</b>			PRINT VERSION NOT TO SCALE			
TITLE: TO-270 WIDE BODY 14 LEAD					DOCUMENT NO: 98ASA10650D			REV: 0	
					CASE NUMBER: 1618-01			29 SEP 2005	
					STANDARD: NON-JEDEC				



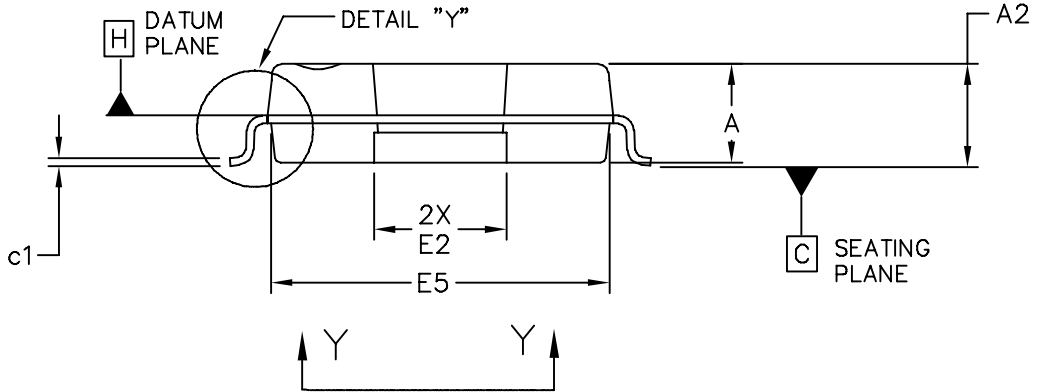
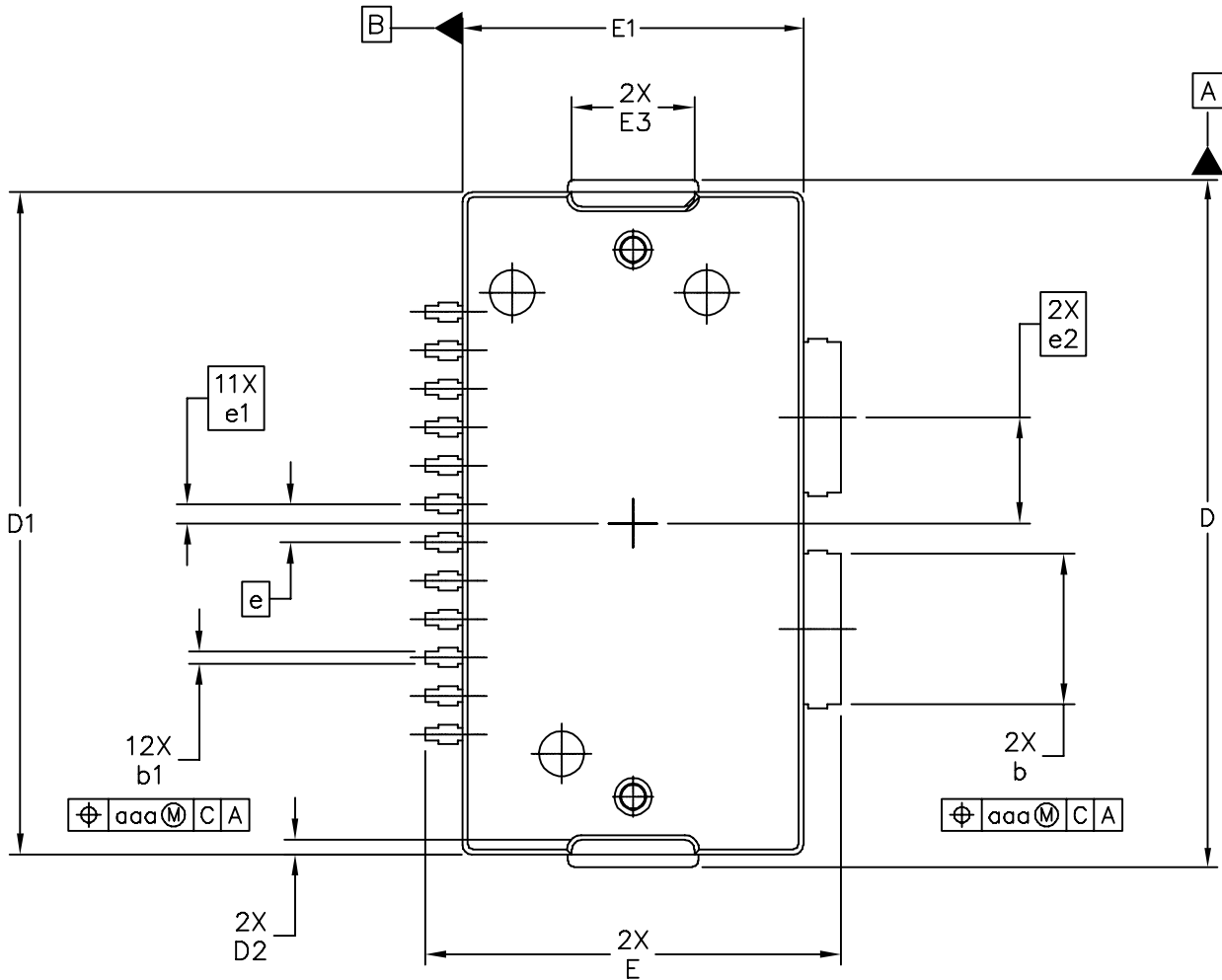

© FREESCALE SEMICONDUCTOR, INC. ALL RIGHTS RESERVED.	<b>MECHANICAL OUTLINE</b>	PRINT VERSION NOT TO SCALE	
TITLE: TO-270 WIDE BODY 14 LEAD GULL WING	DOCUMENT NO: 98ASA10653D	REV: 0	
	CASE NUMBER: 1621-01	30 SEP 2005	
	STANDARD: NON-JEDEC		



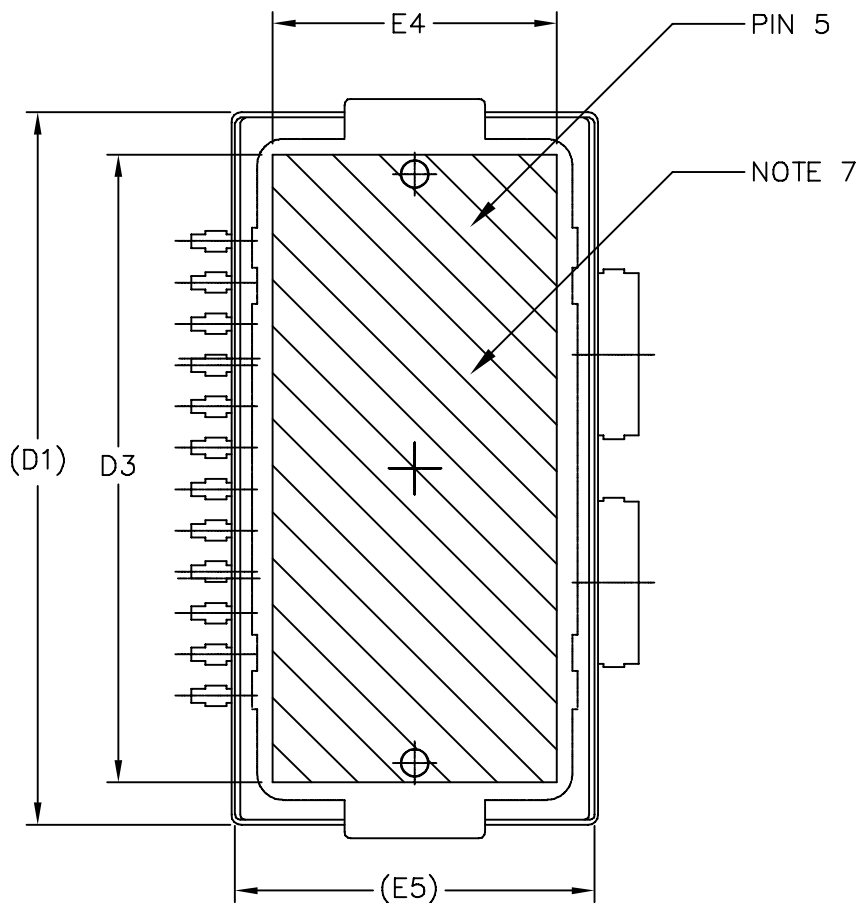

VIEW Y-Y

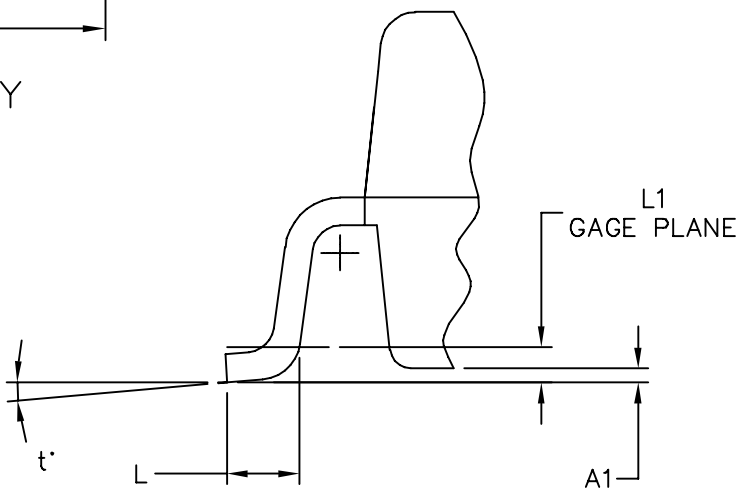

DETAIL "Y"

© FREESCALE SEMICONDUCTOR, INC. ALL RIGHTS RESERVED.	<b>MECHANICAL OUTLINE</b>	PRINT VERSION NOT TO SCALE	
TITLE: TO-270 WIDE BODY 14 LEAD GULL WING	DOCUMENT NO: 98ASA10653D	REV: 0	
	CASE NUMBER: 1621-01	30 SEP 2005	
	STANDARD: NON-JEDEC		



NOTES:

1. CONTROLLING DIMENSION: INCH
2. INTERPRET DIMENSIONS AND TOLERANCES PER ASME Y14.5M-1994.
3. DATUM PLANE -H- IS LOCATED AT THE TOP OF LEAD AND IS COINCIDENT WITH THE LEAD WHERE THE LEAD EXITS THE PLASTIC BODY AT THE TOP OF THE PARTING LINE.
4. DIMENSIONS "D" AND "E1" DO NOT INCLUDE MOLD PROTRUSION. ALLOWABLE PROTRUSION IS .006 PER SIDE. DIMENSIONS "D" AND "E1" DO INCLUDE MOLD MISMATCH AND ARE DETERMINED AT DATUM PLANE -H-.
5. DIMENSIONS "b" AND "b1" DOES NOT INCLUDE DAMBAR PROTRUSION. ALLOWABLE DAMBAR PROTRUSION SHALL BE .005 TOTAL IN EXCESS OF THE "b" AND "b1" DIMENSION AT MAXIMUM MATERIAL CONDITION.
6. DATUMS -A- AND -B- TO BE DETERMINED AT DATUM PLANE -H-.
7. HATCHING REPRESENTS THE EXPOSED AREA OF THE HEAT SLUG.

DIM	INCH		MILLIMETER		DIM	INCH		MILLIMETER	
	MIN	MAX	MIN	MAX		MIN	MAX	MIN	MAX
A	.100	.104	2.54	2.64	L	.018	.024	0.46	0.61
A1	.001	.004	0.02	0.10	L1	.010 BSC		0.25 BSC	
A2	.099	.110	2.51	2.79	b	.154	.160	3.91	4.06
D	.712	.720	18.08	18.29	b1	.010	.016	0.25	0.41
D1	.688	.692	17.48	17.58	c1	.007	.011	.18	.28
D2	.011	.019	0.28	0.48	e	.040 BSC		1.02 BSC	
D3	.600	---	15.24	---	e1	.020 BSC		0.51 BSC	
E	.429	.437	10.9	11.1	e2	.1105 BSC		2.807 BSC	
E1	.353	.357	8.97	9.07	t	2'	8'	2'	8'
E2	.132	.140	3.35	3.56					
E3	.124	.132	3.15	3.35	aaa	.004		.10	
E4	.270	---	6.86	---					
E5	.346	.350	8.79	8.89					
© FREESCALE SEMICONDUCTOR, INC. ALL RIGHTS RESERVED.			<b>MECHANICAL OUTLINE</b>			PRINT VERSION NOT TO SCALE			
TITLE: TO-270 WIDE BODY 14 LEAD GULL WING					DOCUMENT NO: 98ASA10653D			REV: 0	
					CASE NUMBER: 1621-01			30 SEP 2005	
					STANDARD: NON-JEDEC				



## PRODUCT DOCUMENTATION

Refer to the following documents to aid your design process.

### Application Notes

- AN1907: Solder Reflow Attach Method for High Power RF Devices in Plastic Packages
- AN1955: Thermal Measurement Methodology of RF Power Amplifiers
- AN1977: Quiescent Current Thermal Tracking Circuit in the RF Integrated Circuit Family
- AN1987: Quiescent Current Control for the RF Integrated Circuit Device Family
- AN3263: Bolt Down Mounting Method for High Power RF Transistors and RFICs in Over-Molded Plastic Packages

### Engineering Bulletins

- EB212: Using Data Sheet Impedances for RF LDMOS Devices

## REVISION HISTORY

The following table summarizes revisions to this document.

Revision	Date	Description
0	May 2007	<ul style="list-style-type: none"><li>• Initial Release of Data Sheet</li></ul>
1	June 2007	<ul style="list-style-type: none"><li>• Removed Case Operating Temperature from Maximum Ratings table, p. 2. Case Operating Temperature rating will be added to the Maximum Ratings table when parts' Operating Junction Temperature is increased to 225°C.</li></ul>



## **How to Reach Us:**

### **Home Page:**

[www.freescale.com](http://www.freescale.com)

### **Web Support:**

<http://www.freescale.com/support>

### **USA/Europe or Locations Not Listed:**

Freescale Semiconductor, Inc.  
Technical Information Center, EL516  
2100 East Elliot Road  
Tempe, Arizona 85284  
+1-800-521-6274 or +1-480-768-2130  
[www.freescale.com/support](http://www.freescale.com/support)

### **Europe, Middle East, and Africa:**

Freescale Halbleiter Deutschland GmbH  
Technical Information Center  
Schatzbogen 7  
81829 Muenchen, Germany  
+44 1296 380 456 (English)  
+46 8 52200080 (English)  
+49 89 92103 559 (German)  
+33 1 69 35 48 48 (French)  
[www.freescale.com/support](http://www.freescale.com/support)

### **Japan:**

Freescale Semiconductor Japan Ltd.  
Headquarters  
ARCO Tower 15F  
1-8-1, Shimo-Meguro, Meguro-ku,  
Tokyo 153-0064  
Japan  
0120 191014 or +81 3 5437 9125  
[support.japan@freescale.com](mailto:support.japan@freescale.com)

### **Asia/Pacific:**

Freescale Semiconductor Hong Kong Ltd.  
Technical Information Center  
2 Dai King Street  
Tai Po Industrial Estate  
Tai Po, N.T., Hong Kong  
+800 2666 8080  
[support.asia@freescale.com](mailto:support.asia@freescale.com)

### **For Literature Requests Only:**

Freescale Semiconductor Literature Distribution Center  
P.O. Box 5405  
Denver, Colorado 80217  
1-800-441-2447 or 303-675-2140  
Fax: 303-675-2150  
[LDCForFreescaleSemiconductor@hibbertgroup.com](mailto:LDCForFreescaleSemiconductor@hibbertgroup.com)

Information in this document is provided solely to enable system and software implementers to use Freescale Semiconductor products. There are no express or implied copyright licenses granted hereunder to design or fabricate any integrated circuits or integrated circuits based on the information in this document.

Freescale Semiconductor reserves the right to make changes without further notice to any products herein. Freescale Semiconductor makes no warranty, representation or guarantee regarding the suitability of its products for any particular purpose, nor does Freescale Semiconductor assume any liability arising out of the application or use of any product or circuit, and specifically disclaims any and all liability, including without limitation consequential or incidental damages. "Typical" parameters that may be provided in Freescale Semiconductor data sheets and/or specifications can and do vary in different applications and actual performance may vary over time. All operating parameters, including "Typicals", must be validated for each customer application by customer's technical experts. Freescale Semiconductor does not convey any license under its patent rights nor the rights of others. Freescale Semiconductor products are not designed, intended, or authorized for use as components in systems intended for surgical implant into the body, or other applications intended to support or sustain life, or for any other application in which the failure of the Freescale Semiconductor product could create a situation where personal injury or death may occur. Should Buyer purchase or use Freescale Semiconductor products for any such unintended or unauthorized application, Buyer shall indemnify and hold Freescale Semiconductor and its officers, employees, subsidiaries, affiliates, and distributors harmless against all claims, costs, damages, and expenses, and reasonable attorney fees arising out of, directly or indirectly, any claim of personal injury or death associated with such unintended or unauthorized use, even if such claim alleges that Freescale Semiconductor was negligent regarding the design or manufacture of the part.

Freescale™ and the Freescale logo are trademarks of Freescale Semiconductor, Inc. All other product or service names are the property of their respective owners.  
© Freescale Semiconductor, Inc. 2007. All rights reserved.

