



# 4-Pin $\mu$ P Voltage Monitors with Manual Reset Input

MAX811/MAX812

## General Description

The MAX811/MAX812 are low-power microprocessor ( $\mu$ P) supervisory circuits used to monitor power supplies in  $\mu$ P and digital systems. They provide excellent circuit reliability and low cost by eliminating external components and adjustments when used with 5V-powered or 3V-powered circuits. The MAX811/MAX812 also provide a debounced manual reset input.

These devices perform a single function: They assert a reset signal whenever the  $V_{CC}$  supply voltage falls below a preset threshold, keeping it asserted for at least 140ms after  $V_{CC}$  has risen above the reset threshold. The only difference between the two devices is that the MAX811 has an active-low RESET output (which is guaranteed to be in the correct state for  $V_{CC}$  down to 1V), while the MAX812 has an active-high RESET output. The reset comparator is designed to ignore fast transients on  $V_{CC}$ . Reset thresholds are available for operation with a variety of supply voltages.

Low supply current makes the MAX811/MAX812 ideal for use in portable equipment. The devices come in a 4-pin SOT143 package.

## Applications

- Computers
- Controllers
- Intelligent Instruments
- Critical  $\mu$ P and  $\mu$ C Power Monitoring
- Portable/Battery-Powered Equipment

## Typical Operating Circuit

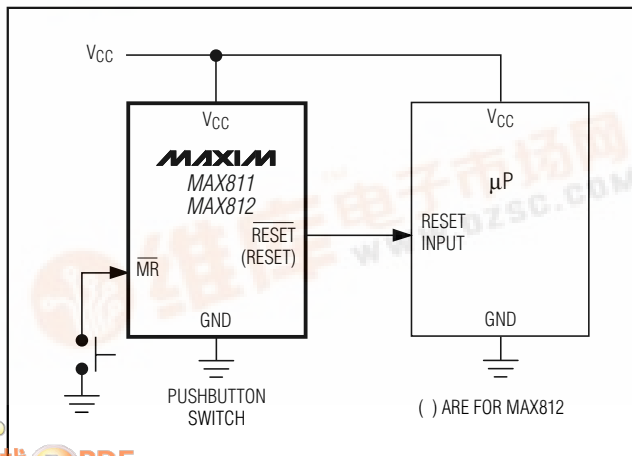

## Features

- ◆ Precision Monitoring of 3V, 3.3V, and 5V Power-Supply Voltages
- ◆ 6 $\mu$ A Supply Current
- ◆ 140ms Min Power-On Reset Pulse Width; RESET Output (MAX811), RESET Output (MAX812)
- ◆ Guaranteed Over Temperature
- ◆ Guaranteed RESET Valid to  $V_{CC} = 1V$  (MAX811)
- ◆ Power-Supply Transient Immunity
- ◆ No External Components
- ◆ 4-Pin SOT143 Package

## Ordering Information

PART*	TEMP. RANGE	PIN-PACKAGE
MAX811_EUS-T	-40°C to +85°C	4 SOT143
MAX812_EUS-T	-40°C to +85°C	4 SOT143

\* This part offers a choice of five different reset threshold voltages. Select the letter corresponding to the desired nominal reset threshold voltage, and insert it into the blank to complete the part number.

RESET THRESHOLD	
SUFFIX	VOLTAGE (V)
L	4.63
M	4.38
T	3.08
S	2.93
R	2.63

## Pin Configuration

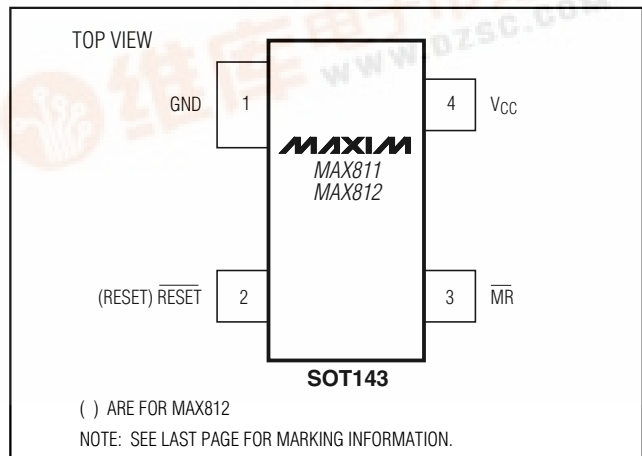

# 4-Pin $\mu$ P Voltage Monitors with Manual Reset Input

## ABSOLUTE MAXIMUM RATINGS

Terminal Voltage (with respect to GND)

V<sub>CC</sub> .....-0.3V to 6.0V

All Other Inputs.....-0.3V to (V<sub>CC</sub> + 0.3V)

Input Current, V<sub>CC</sub>,  $\overline{\text{MR}}$  .....20mA

Output Current, RESET or  $\overline{\text{RESET}}$  .....20mA

Continuous Power Dissipation (T<sub>A</sub> = +70°C)

SOT143 (derate 4mW/°C above +70°C) 320mW

Operating Temperature Range .....-40°C to +85°C

Storage Temperature Range .....-65°C to +160°C

Lead Temperature (soldering, 10sec) .....+300°C

Stresses beyond those listed under "Absolute Maximum Ratings" may cause permanent damage to the device. These are stress ratings only, and functional operation of the device at these or any other conditions beyond those indicated in the operational sections of the specifications is not implied. Exposure to absolute maximum rating conditions for extended periods may affect device reliability.

## ELECTRICAL CHARACTERISTICS

(V<sub>CC</sub> = 5V for L/M versions, V<sub>CC</sub> = 3.3V for T/S versions, V<sub>CC</sub> = 3V for R version, T<sub>A</sub> = -40°C to +85°C, unless otherwise noted. Typical values are at T<sub>A</sub> = +25°C.) (Note 1)

PARAMETER	SYMBOL	CONDITIONS	MIN	TYP	MAX	UNITS	
Operating Voltage Range	V <sub>CC</sub>	T <sub>A</sub> = 0°C to +70°C	1.0		5.5	V	
		T <sub>A</sub> = -40°C to +85°C	1.2				
Supply Current	I <sub>CC</sub>	MAX81_L/M, V <sub>CC</sub> = 5.5V, I <sub>OUT</sub> = 0		6	15	$\mu$ A	
		MAX81_R/S/T, V <sub>CC</sub> = 3.6V, I <sub>OUT</sub> = 0		2.7	10		
Reset Threshold	V <sub>TH</sub>	MAX81_L	T <sub>A</sub> = +25°C	4.54	4.63	4.72	V
			T <sub>A</sub> = -40°C to +85°C	4.50		4.75	
		MAX81_M	T <sub>A</sub> = +25°C	4.30	4.38	4.46	
			T <sub>A</sub> = -40°C to +85°C	4.25		4.50	
		MAX81_T	T <sub>A</sub> = +25°C	3.03	3.08	3.14	
			T <sub>A</sub> = -40°C to +85°C	3.00		3.15	
		MAX81_S	T <sub>A</sub> = +25°C	2.88	2.93	2.98	
			T <sub>A</sub> = -40°C to +85°C	2.85		3.00	
MAX81_R	T <sub>A</sub> = +25°C	2.58	2.63	2.68			
	T <sub>A</sub> = -40°C to +85°C	2.55		2.70			
Reset Threshold Tempco			30			ppm/°C	
V <sub>CC</sub> to Reset Delay (Note 2)		V <sub>OD</sub> = 125mV, MAX81_L/M		40		$\mu$ s	
		V <sub>OD</sub> = 125mV, MAX81_R/S/T		20			
Reset Active Timeout Period	t <sub>RP</sub>	V <sub>CC</sub> = V <sub>TH</sub> (MAX)	140		560	ms	
$\overline{\text{MR}}$ Minimum Pulse Width	t <sub>MR</sub>		10			$\mu$ s	
$\overline{\text{MR}}$ Glitch Immunity (Note 3)				100		ns	
$\overline{\text{MR}}$ to Reset Propagation Delay (Note 2)	t <sub>MD</sub>			0.5		$\mu$ s	
$\overline{\text{MR}}$ Input Threshold	V <sub>IH</sub>	V <sub>CC</sub> > V <sub>TH</sub> (MAX), MAX81_L/M	2.3		V		
	V <sub>IL</sub>		0.8				
	V <sub>IH</sub>	V <sub>CC</sub> > V <sub>TH</sub> (MAX), MAX81_R/S/T	0.7 x V <sub>CC</sub>				
	V <sub>IL</sub>		0.25 x V <sub>CC</sub>				
$\overline{\text{MR}}$ Pull-Up Resistance			10	20	30	k $\Omega$	
RESET Output Voltage (MAX812)	V <sub>OH</sub>	I <sub>SOURCE</sub> = 150 $\mu$ A, 1.8V < V <sub>CC</sub> < V <sub>TH</sub> (MIN)	0.8V <sub>CC</sub>		V		
	V <sub>OL</sub>	MAX812R/S/T only, I <sub>SINK</sub> = 1.2mA, V <sub>CC</sub> = V <sub>TH</sub> (MAX)	0.3				
		MAX812L/M only, I <sub>SINK</sub> = 3.2mA, V <sub>CC</sub> = V <sub>TH</sub> (MAX)	0.4				



# 4-Pin $\mu$ P Voltage Monitors with Manual Reset Input

MAX811/MAX812

## ELECTRICAL CHARACTERISTICS (continued)

( $V_{CC} = 5V$  for L/M versions,  $V_{CC} = 3.3V$  for T/S versions,  $V_{CC} = 3V$  for R version,  $T_A = -40^{\circ}C$  to  $+85^{\circ}C$ , unless otherwise noted. Typical values are at  $T_A = +25^{\circ}C$ .) (Note 1)

PARAMETER	SYMBOL	CONDITIONS	MIN	TYP	MAX	UNITS
RESET Output Voltage (MAX811)	VOL	MAX811R/S/T only, $I_{SINK} = 1.2mA$ , $V_{CC} = V_{TH(MIN)}$			0.3	V
		MAX811L/M only, $I_{SINK} = 3.2mA$ , $V_{CC} = V_{TH(MIN)}$			0.4	
		$I_{SINK} = 50\mu A$ , $V_{CC} > 1.0V$			0.3	
	VOH	MAX811R/S/T only, $I_{SOURCE} = 500\mu A$ , $V_{CC} > V_{TH(MAX)}$	0.8V <sub>CC</sub>			
		MAX811L/M only, $I_{SOURCE} = 800\mu A$ , $V_{CC} > V_{TH(MAX)}$	V <sub>CC</sub> - 1.5			

**Note 1:** Production testing done at  $T_A = +25^{\circ}C$ , over temperature limits guaranteed by design using six sigma design limits.

**Note 2:**  $\overline{RESET}$  output for MAX811, RESET output for MAX812.

**Note 3:** "Glitches" of 100ns or less typically will not generate a reset pulse.



# 4-Pin $\mu$ P Voltage Monitors with Manual Reset Input

## Typical Operating Characteristics

( $T_A = +25^\circ\text{C}$ , unless otherwise noted.)

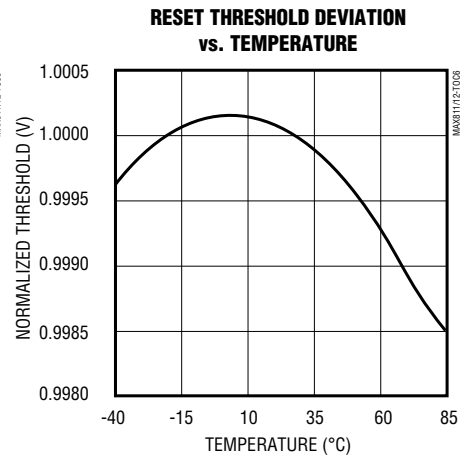
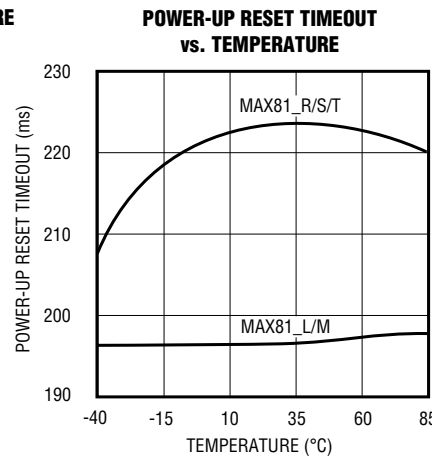
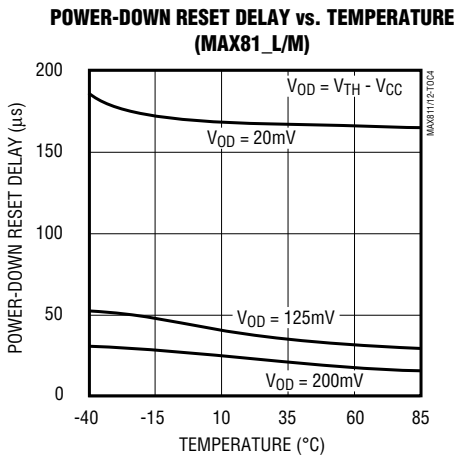
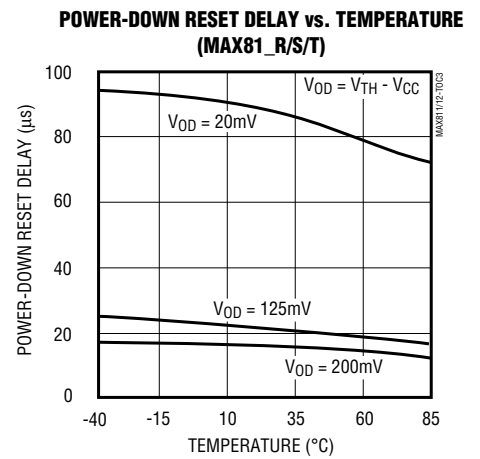
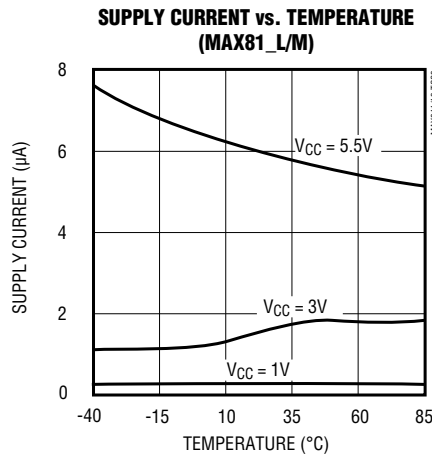
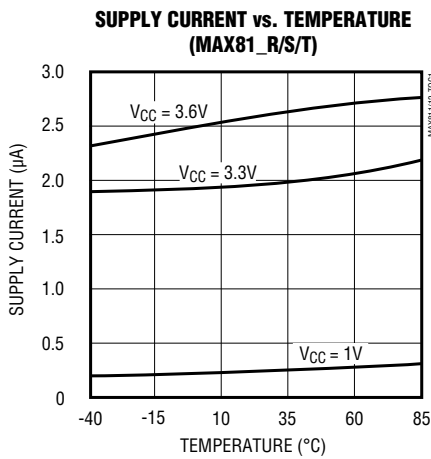

# 4-Pin $\mu$ P Voltage Monitors with Manual Reset Input

MAX811/MAX812

## Pin Description

PIN		NAME	FUNCTION
MAX811	MAX812		
1	1	GND	Ground
2	—	$\overline{\text{RESET}}$	Active-Low Reset Output. $\overline{\text{RESET}}$ remains low while $V_{CC}$ is below the reset threshold or while $\overline{\text{MR}}$ is held low. $\overline{\text{RESET}}$ remains low for the Reset Active Timeout Period ( $t_{RP}$ ) after the reset conditions are terminated.
—	2	RESET	Active-High Reset Output. RESET remains high while $V_{CC}$ is below the reset threshold or while $\overline{\text{MR}}$ is held low. RESET remains high for Reset Active Timeout Period ( $t_{RP}$ ) after the reset conditions are terminated.
3	3	$\overline{\text{MR}}$	Manual Reset Input. A logic low on $\overline{\text{MR}}$ asserts reset. Reset remains asserted as long as $\overline{\text{MR}}$ is low and for 180ms after $\overline{\text{MR}}$ returns high. This active-low input has an internal 20k $\Omega$ pull-up resistor. It can be driven from a TTL or CMOS-logic line, or shorted to ground with a switch. Leave open if unused.
4	4	VCC	+5V, +3.3V, or +3V Supply Voltage

## Detailed Description

### Reset Output

A microprocessor's ( $\mu$ P's) reset input starts the  $\mu$ P in a known state. These  $\mu$ P supervisory circuits assert reset to prevent code execution errors during power-up, power-down, or brownout conditions.

$\overline{\text{RESET}}$  is guaranteed to be a logic low for  $V_{CC} > 1V$ . Once  $V_{CC}$  exceeds the reset threshold, an internal timer keeps  $\overline{\text{RESET}}$  low for the reset timeout period; after this interval,  $\overline{\text{RESET}}$  goes high.

If a brownout condition occurs ( $V_{CC}$  dips below the reset threshold),  $\overline{\text{RESET}}$  goes low. Any time  $V_{CC}$  goes below the reset threshold, the internal timer resets to zero, and  $\overline{\text{RESET}}$  goes low. The internal timer starts after  $V_{CC}$  returns above the reset threshold, and  $\overline{\text{RESET}}$  remains low for the reset timeout period.

The manual reset input ( $\overline{\text{MR}}$ ) can also initiate a reset. See the *Manual Reset Input* section.

The MAX812 has an active-high RESET output that is the inverse of the MAX811's  $\overline{\text{RESET}}$  output.

### Manual Reset Input

Many  $\mu$ P-based products require manual reset capability, allowing the operator, a test technician, or external logic circuitry to initiate a reset. A logic low on  $\overline{\text{MR}}$  asserts reset. Reset remains asserted while  $\overline{\text{MR}}$  is low, and for the Reset Active Timeout Period ( $t_{RP}$ ) after  $\overline{\text{MR}}$  returns high. This input has an internal 20k $\Omega$  pull-up resistor, so it can be left open if it is not used.  $\overline{\text{MR}}$  can be driven with TTL or CMOS-logic levels, or with open-drain/collector outputs. Connect a normally open momentary switch from  $\overline{\text{MR}}$  to GND to create a manual-reset function; external debounce circuitry is not required. If  $\overline{\text{MR}}$  is driven from long cables or if the device is used in a noisy environment, connecting a 0.1 $\mu$ F capacitor from  $\overline{\text{MR}}$  to ground provides additional noise immunity.

### Reset Threshold Accuracy

The MAX811/MAX812 are ideal for systems using a 5V  $\pm$ 5% or 3V  $\pm$ 5% power supply with ICs specified for 5V  $\pm$ 10% or 3V  $\pm$ 10%, respectively. They are designed to meet worst-case specifications over temperature. The reset is guaranteed to assert after the power supply falls out of regulation, but before power drops below the minimum specified operating voltage range for the system ICs. The thresholds are pre-trimmed and exhibit tight distribution, reducing the range over which an undesirable reset may occur.



## 4-Pin $\mu\text{P}$ Voltage Monitors with Manual Reset Input

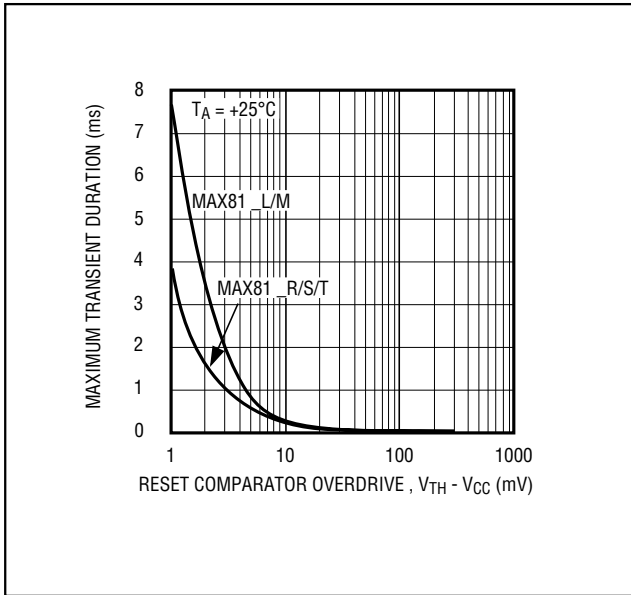

Figure 1. Maximum Transient Duration without Causing a Reset Pulse vs. Comparator Overdrive

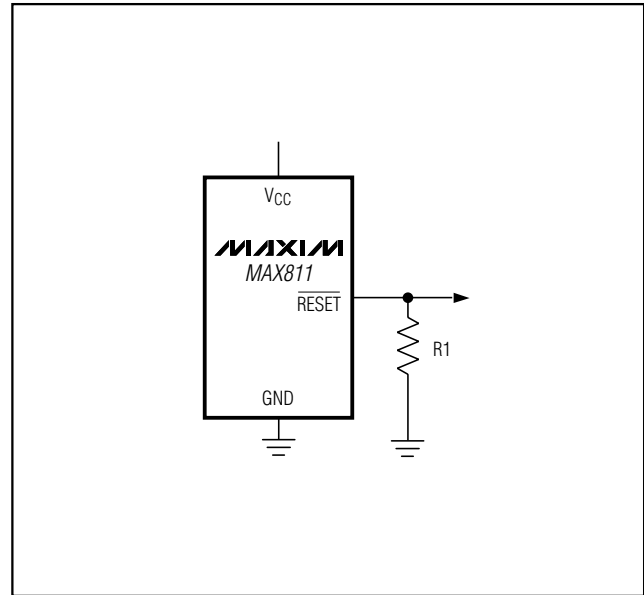

Figure 2. RESET Valid to  $V_{CC} = \text{Ground}$  Circuit

### Applications Information

#### Negative-Going $V_{CC}$ Transients

In addition to issuing a reset to the  $\mu\text{P}$  during power-up, power-down, and brownout conditions, the MAX811/MAX812 are relatively immune to short duration negative-going  $V_{CC}$  transients (glitches).

Figure 1 shows typical transient durations vs. reset comparator overdrive, for which the MAX811/MAX812 do not generate a reset pulse. This graph was generated using a negative-going pulse applied to  $V_{CC}$ , starting above the actual reset threshold and ending below it by the magnitude indicated (reset comparator overdrive). The graph indicates the typical maximum pulse width a negative-going  $V_{CC}$  transient may have without causing a reset pulse to be issued. As the magnitude of the transient increases (goes farther below the reset threshold), the maximum allowable pulse width decreases. Typically, a  $V_{CC}$  transient that goes 125mV below the reset threshold and lasts 40 $\mu\text{s}$  or less (MAX811\_L/M) or 20 $\mu\text{s}$  or less (MAX811\_T/S/R) will not cause a reset pulse to be issued. A 0.1 $\mu\text{F}$  capacitor mounted as close as possible to  $V_{CC}$  provides additional transient immunity.

#### Ensuring a Valid RESET Output Down to $V_{CC} = 0\text{V}$

When  $V_{CC}$  falls below 1V, the MAX811  $\overline{\text{RESET}}$  output no longer sinks current—it becomes an open circuit. Therefore, high-impedance CMOS-logic inputs connected to the RESET output can drift to undetermined voltages. This presents no problem in most applications, since most  $\mu\text{P}$  and other circuitry is inoperative with  $V_{CC}$  below 1V. However, in applications where the RESET output must be valid down to 0V, adding a pull-down resistor to the RESET pin will cause any stray leakage currents to flow to ground, holding  $\overline{\text{RESET}}$  low (Figure 2). R1's value is not critical; 100k $\Omega$  is large enough not to load RESET and small enough to pull RESET to ground.

A 100k $\Omega$  pull-up resistor to  $V_{CC}$  is also recommended for the MAX812 if RESET is required to remain valid for  $V_{CC} < 1\text{V}$ .

## 4-Pin $\mu$ P Voltage Monitors with Manual Reset Input

### Interfacing to $\mu$ Ps with Bidirectional Reset Pins

$\mu$ Ps with bidirectional reset pins (such as the Motorola 68HC11 series) can contend with the MAX811/MAX812 reset outputs. If, for example, the MAX811  $\overline{\text{RESET}}$  output is asserted high and the  $\mu$ P wants to pull it low, indeterminate logic levels may result. To correct such cases, connect a  $4.7\text{k}\Omega$  resistor between the MAX811  $\overline{\text{RESET}}$  (or MAX812  $\overline{\text{RESET}}$ ) output and the  $\mu$ P reset I/O (Figure 3). Buffer the reset output to other system components.

### Chip Information

TRANSISTOR COUNT: 341

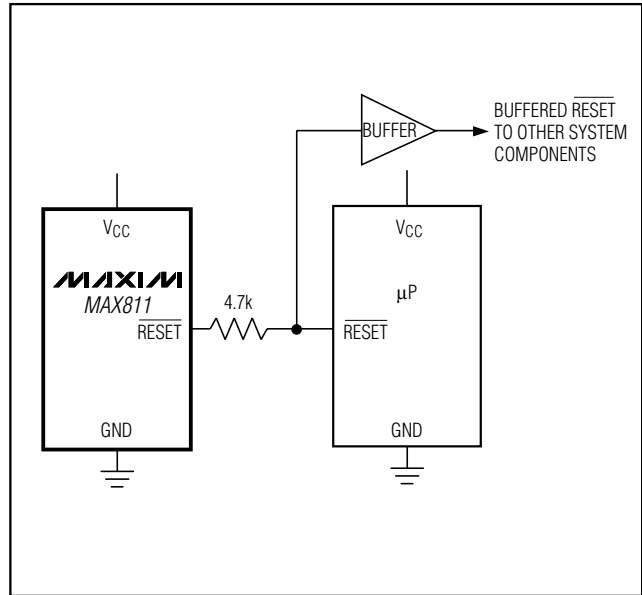
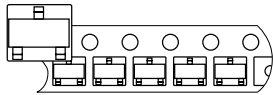
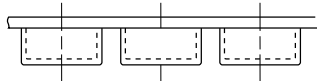
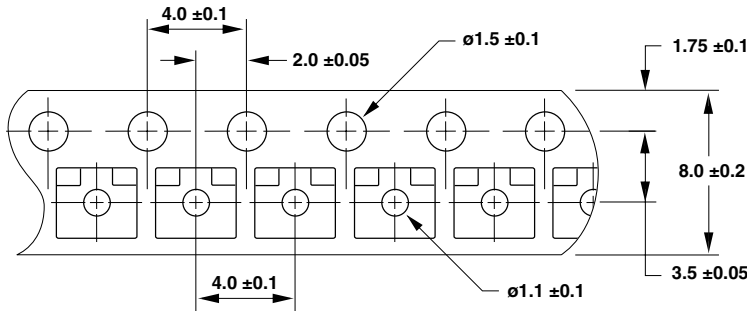

Figure 3. Interfacing to  $\mu$ Ps with Bidirectional Reset I/O

MAX811/MAX812

# 4-Pin $\mu$ P Voltage Monitors with Manual Reset Input

## Package Information



NOTE: DIMENSIONS ARE IN MM.  
AND FOLLOW EIA481-1 STANDARD.

**MARKING INFORMATION<sup>†</sup>**

LOT SPECIFIC CODE  
X X J X X

AMAA or KABB = MAX811L  
 ANAA or KABC = MAX811M  
 APAA or KABD = MAX811T  
 AQAA or KABE = MAX811S  
 ARAA or KABF = MAX811R  
 ASAA or KABG = MAX812L  
 ATAA or KABH = MAX812M  
 AVAA or KABI = MAX812T  
 AWAA or KABJ = MAX812S  
 AXAA or KABK = MAX812R

<sup>†</sup> ICs MAY ALSO BE MARKED WITH FULL PART NAME: 811L, 811M...

DIM	INCHES		MILLIMETERS	
	MIN	MAX	MIN	MAX
A	0.031	0.047	0.787	1.194
A1	0.001	0.005	0.025	0.127
B	0.014	0.022	0.356	0.559
B1	0.030	0.038	0.762	0.965
C	0.0034	0.006	0.086	0.152
D	0.105	0.120	2.667	3.048
E	0.047	0.055	1.194	1.397
e1	0.071	0.079	1.803	2.007
e2	0.008 BSC		0.200 BSC	
H	0.082	0.098	2.083	2.489
I	0.004	0.012	0.102	0.305
S	0.018	0.024	0.450	0.600
$\alpha$	0°	8°	0°	8°

NOTES:  
 1. D&E DO NOT INCLUDE MOLD FLASH.  
 2. MOLD FLASH OR PROTRUSIONS NOT TO EXCEED .15mm (.006")  
 3. CONTROLLING DIMENSION: MILLIMETER

PROPRIETARY INFORMATION		
TITLE: PACKAGE OUTLINE, SOT-143, 4L		
APPROVAL	DOCUMENT CONTROL NO.	REV
	21-0052	C 1/1

SOT-143, 4L

Maxim cannot assume responsibility for use of any circuitry other than circuitry entirely embodied in a Maxim product. No circuit patent licenses are implied. Maxim reserves the right to change the circuitry and specifications without notice at any time.

8 Maxim Integrated Products, 120 San Gabriel Drive, Sunnyvale, CA 94086 408-737-7600