

March 1995

LM4861 Boomer® Audio Power Amplifier Series 1/2W Audio Power Amplifier with Shutdown Mode

General Description

The LM4861 is a bridge-connected audio power amplifier capable of delivering 500 mW of continuous average power to an 8Ω load with less than 1% (THD+N) over the audio spectrum using a 5V power supply.

Boomer audio power amplifiers were designed specifically to provide high quality output power with a minimal amount of external components using surface mount packaging. Since the LM4861 does not require output coupling capacitors, bootstrap capacitors, or snubber networks, it is optimally suited for low-power portable systems.

The LM4861 features an externally controlled, low-power consumption shutdown mode, as well as an internal thermal shutdown protection mechanism.

The unity-gain stable LM4861 can be configured by external gain-setting resistors for differential gains of 1 to 10 without the use of external compensation components.

Key Specifications

- THD+N at 500 mW continuous average output power into 8Ω 1% (max)
- Instantaneous peak output power > 1W
- Shutdown current 0.6 μA (typ)

Features

- No output coupling capacitors, bootstrap capacitors, or snubber circuits are necessary
- Small Outline (SO) packaging
- Compatible with PC power supplies
- Thermal shutdown protection circuitry
- Unity-gain stable
- External Gain Configuration Capability

Applications

- Personal computers
- Portable consumer products
- Cellular phones
- Self-powered speakers
- Toys and games

Typical Application

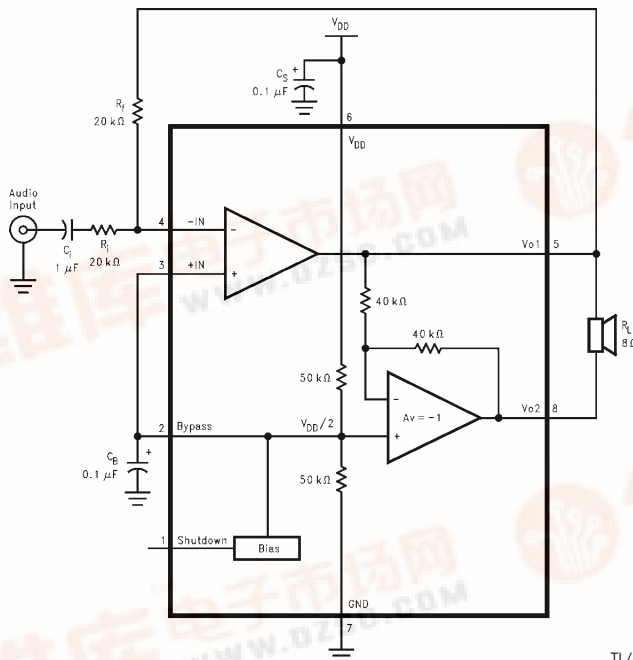

Connection Diagram

Small Outline Package

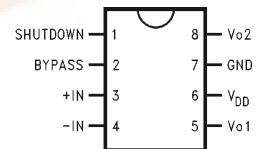

Top View

Order Number LM4861M
See NS Package Number M08A

FIGURE 1. Typical Audio Amplifier Application Circuit

The Boomer® registered trademark is licensed to National Semiconductor for audio integrated circuits by Rockford Corporation. Patents Pending

LM4861 1/2W Audio Power Amplifier with Shutdown Mode



Absolute Maximum Ratings

If Military/Aerospace specified devices are required, please contact the National Semiconductor Sales Office/Distributors for availability and specifications.

Supply Voltage	6.0V
Storage Temperature	-65°C to +150°C
Input Voltage	-0.3V to $V_{DD} + 0.3V$
Power Dissipation (Note 3)	Internally limited
ESD Susceptibility (Note 4)	3000V
ESD Susceptibility (Note 5)	250V
Junction Temperature	150°C

Soldering Information

Small Outline Package	215°C
Vapor Phase (60 sec.)	
Infrared (15 sec.)	220°C

See AN-450 "Surface Mounting and their Effects on Product Reliability" for other methods of soldering surface mount devices.

Operating Ratings

Temperature Range	$-20^{\circ}\text{C} \leq T_A \leq +85^{\circ}\text{C}$
$T_{MIN} \leq T_A \leq T_{MAX}$	
Supply Voltage	$2.7V \leq V_{DD} \leq 5.5V$

Electrical Characteristics (Notes 1, 2)

The following specifications apply for $V_{DD} = 5V$, $R_L = 8\Omega$ unless otherwise specified. Limits apply for $T_A = 25^{\circ}\text{C}$.

Symbol	Parameter	Conditions	LM4861		Units (Limits)
			Typical (Note 6)	Limit (Note 7)	
V_{DD}	Supply Voltage			2.7 5.5	V (min) V (max)
I_{DD}	Quiescent Power Supply Current	$V_{IN} = 0V$, $I_O = 0A$ (Note 8)	6.5	10.0	mA (max)
I_{SD}	Shutdown Current	$V_{pin1} = V_{DD}$ (Note 9)	0.6		μA
V_{OS}	Output Offset Voltage	$V_{IN} = 0V$	5.0	50.0	mV (max)
P_O	Output Power	THD + N = 1% (max); $f = 1\text{ kHz}$		0.50	W (min)
THD + N	Total Harmonic Distortion + Noise	$P_O = 500\text{ mWrms}$; $20\text{ Hz} \leq f \leq 20\text{ kHz}$	0.45		%
PSRR	Power Supply Rejection Ratio	$V_{DD} = 4.9V$ to $5.1V$	65		dB

Note 1: All voltages are measured with respect to the ground pin, unless otherwise specified.

Note 2: *Absolute Maximum Ratings* indicate limits beyond which damage to the device may occur. *Operating Ratings* indicate conditions for which the device is functional, but do not guarantee specific performance limits. *Electrical Characteristics* state DC and AC electrical specifications under particular test conditions which guarantee specific performance limits. This assumes that the device is within the Operating Ratings. Specifications are not guaranteed for parameters where no limit is given, however, the typical value is a good indication of device performance.

Note 3: The maximum power dissipation must be derated at elevated temperatures and is dictated by T_{JMAX} , θ_{JA} , and the ambient temperature T_A . The maximum allowable power dissipation is $P_{DMAX} = (T_{JMAX} - T_A)/\theta_{JA}$ or the number given in the Absolute Maximum Ratings, whichever is lower. For the LM4861, $T_{JMAX} = 150^{\circ}\text{C}$, and the typical junction-to-ambient thermal resistance, when board mounted, is 170°C/W .

Note 4: Human body model, 100 pF discharged through a 1.5 k Ω resistor.

Note 5: Machine Model, 220 pF–240 pF discharged through all pins.

Note 6: Typicals are measured at 25°C and represent the parametric norm.

Note 7: Limits are guaranteed to National's AOQL (Average Outgoing Quality Level).

Note 8: The quiescent power supply current depends on the offset voltage when a practical load is connected to the amplifier.

Note 9: Shutdown current has a wide distribution. For power management sensitive designs, contact your local National Semiconductor Sales Office.



High Gain Application Circuit

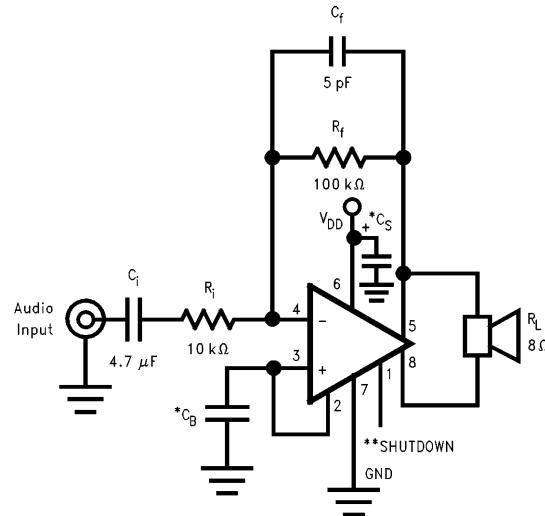

FIGURE 2. Audio Amplifier with $A_{VD} = 20$

TL/H/11986-3

Single Ended Application Circuit

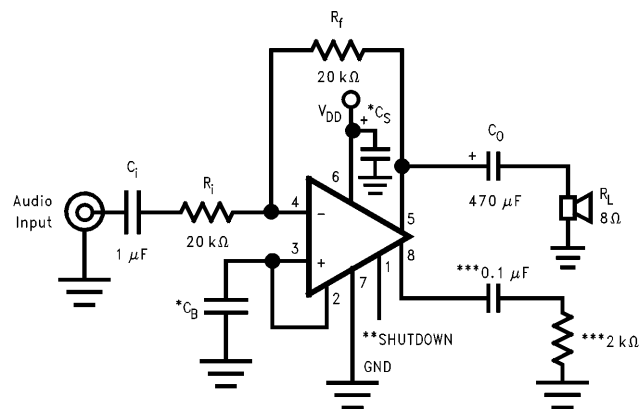

FIGURE 3. Single-Ended Amplifier with $A_V = -1$

TL/H/11986-4

- * C_S and C_B size depend on specific application requirements and constraints. Typical values of C_S and C_B are $0.1 \mu\text{F}$.
- **Pin 1 should be connected to V_{DD} to disable the amplifier or to GND to enable the amplifier. This pin should not be left floating.
- ***These components create a "dummy" load for pin 8 for stability purposes.



External Components Description (Figures 1, 2)

Components	Functional Description
1. R_i	Inverting input resistance which sets the closed-loop gain in conjunction with R_f . This resistor also forms a high pass filter with C_i at $f_C = 1/(2\pi R_i C_i)$.
2. C_i	Input coupling capacitor which blocks DC voltage at the amplifier's input terminals. Also creates a highpass filter with R_i at $f_C = 1/(2\pi R_i C_i)$.
3. R_f	Feedback resistance which sets closed-loop gain in conjunction with R_i .
4. C_S	Supply bypass capacitor which provides power supply filtering. Refer to the Application Information section for proper placement and selection of supply bypass capacitor.
5. C_B	Bypass pin capacitor which provides half supply filtering. Refer to the Application Information section for proper placement and selection of bypass capacitor.
6. C_f^*	Used when a differential gain of over 10 is desired. C_f in conjunction with R_f creates a low-pass filter which bandwidth limits the amplifier and prevents high frequency oscillation bursts. $f_C = 1/(2\pi R_f C_f)$

*Optional component dependent upon specific design requirements. Refer to the **Application Information** section for more information.

Typical Performance Characteristics

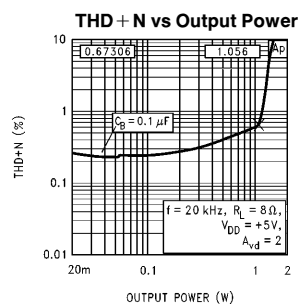
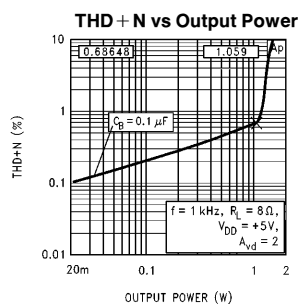
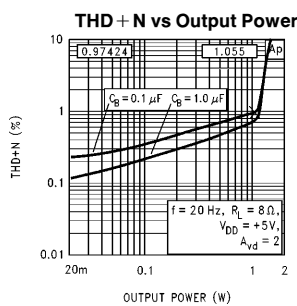
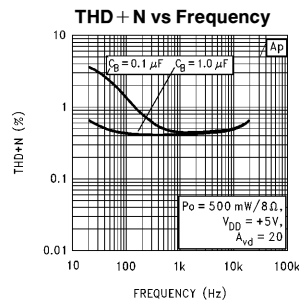
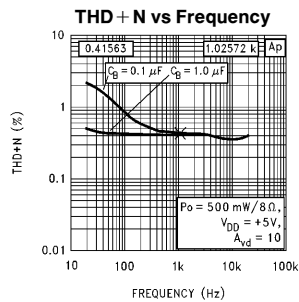
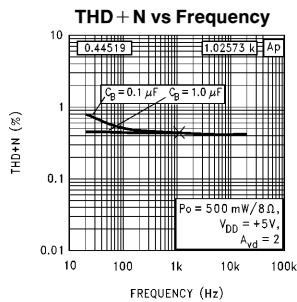

TL/H/11986-5

Typical Performance Characteristics (Continued)

Supply Current vs Time in Shutdown Mode

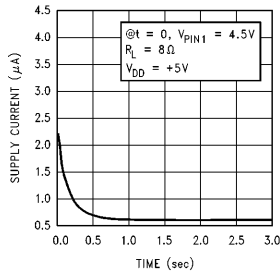

Supply Current vs Supply Voltage

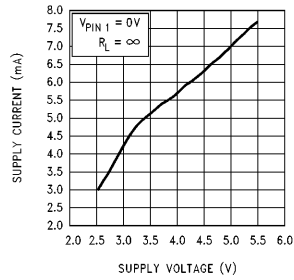

Power Derating Curve

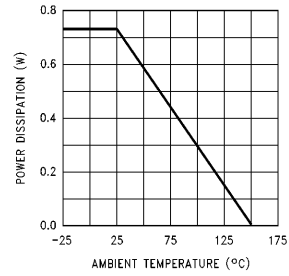

Noise Floor vs Frequency

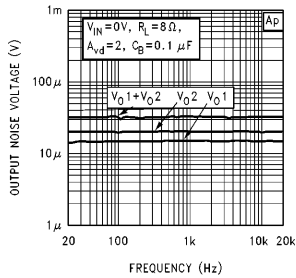

Supply Current Distribution vs Temperature

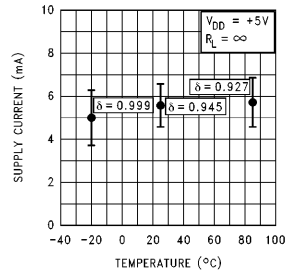

Power Dissipation vs Output Power

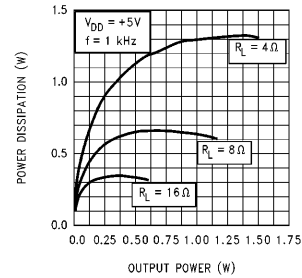

Output Power vs Load Resistance

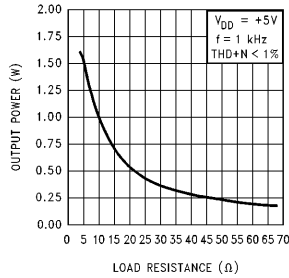

Output Power vs Supply Voltage

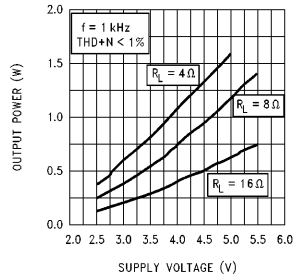

Open Loop Frequency Response

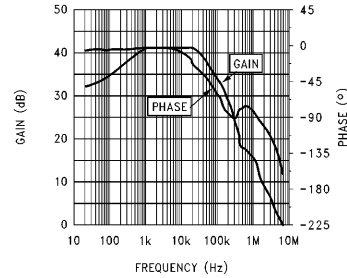

Power Supply Rejection Ratio

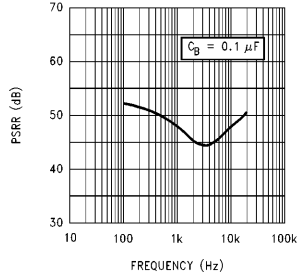

TL/H/11986-6

Application Information

BRIDGE CONFIGURATION EXPLANATION

As shown in *Figure 1*, the LM4861 has two operational amplifiers internally, allowing for a few different amplifier configurations. The first amplifier's gain is externally configurable, while the second amplifier is internally fixed in a unity-gain, inverting configuration. The closed-loop gain of the first amplifier is set by selecting the ratio of R_f to R_i while the second amplifier's gain is fixed by the two internal 40 k Ω resistors. *Figure 1* shows that the output of amplifier one serves as the input to amplifier two which results in both amplifiers producing signals identical in magnitude, but out of phase 180°. Consequently, the differential gain for the IC is:

$$A_{vd} = 2 * (R_f/R_i)$$

By driving the load differentially through outputs V_{O1} and V_{O2} , an amplifier configuration commonly referred to as "bridged mode" is established. Bridged mode operation is different from the classical single-ended amplifier configuration where one side of its load is connected to ground.

A bridge amplifier design has a few distinct advantages over the single-ended configuration, as it provides differential drive to the load, thus doubling output swing for a specified supply voltage. Consequently, four times the output power is possible as compared to a single-ended amplifier under the same conditions. This increase in attainable output power assumes that the amplifier is not current limited or clipped. In order to choose an amplifier's closed-loop gain without causing excessive clipping which will damage high frequency transducers used in loudspeaker systems, please refer to the **Audio Power Amplifier Design** section.

A bridge configuration, such as the one used in Boomer Audio Power Amplifiers, also creates a second advantage over single-ended amplifiers. Since the differential outputs, V_{O1} and V_{O2} , are biased at half-supply, no net DC voltage exists across the load. This eliminates the need for an output coupling capacitor which is required in a single supply, single-ended amplifier configuration. Without an output coupling capacitor in a single supply, single-ended amplifier, the half-supply bias across the load would result in both increased internal IC power dissipation and also permanent loudspeaker damage. An output coupling capacitor forms a high pass filter with the load requiring that a large value such as 470 μ F be used with an 8 Ω load to preserve low frequency response. This combination does not produce a flat response down to 20 Hz, but does offer a compromise between printed circuit board size and system cost, versus low frequency response.

POWER DISSIPATION

Power dissipation is a major concern when designing a successful amplifier, whether the amplifier is bridged or single-ended. A direct consequence of the increased power delivered to the load by a bridge amplifier is an increase in internal power dissipation. Equation 1 states the maximum power dissipation point for a bridge amplifier operating at a given supply voltage and driving a specified output load.

$$P_{DMAX} = 4*(V_{DD})^2/(2\pi^2R_L) \quad (1)$$

Since the LM4861 has two operational amplifiers in one package, the maximum internal power dissipation is 4 times that of a single-ended amplifier. Even with this substantial

increase in power dissipation, the LM4861 does not require heatsinking. From Equation 1, assuming a 5V power supply and an 8 Ω load, the maximum power dissipation point is 625 mW. The maximum power dissipation point obtained from Equation 1 must not be greater than the power dissipation that results from Equation 2:

$$P_{DMAX} = (T_{JMAX} - T_A)/\theta_{JA} \quad (2)$$

For the LM4861 surface mount package, $\theta_{JA} = 170^\circ\text{C}/\text{W}$ and $T_{JMAX} = 150^\circ\text{C}$. Depending on the ambient temperature, T_A , of the system surroundings, Equation 2 can be used to find the maximum internal power dissipation supported by the IC packaging. If the result of Equation 1 is greater than that of Equation 2, then either the supply voltage must be decreased or the load impedance increased. For the typical application of a 5V power supply, with an 8 Ω load, the maximum ambient temperature possible without violating the maximum junction temperature is approximately 44°C provided that device operation is around the maximum power dissipation point. Power dissipation is a function of output power and thus, if typical operation is not around the maximum power dissipation point, the ambient temperature can be increased. Refer to the **Typical Performance Characteristics** curves for power dissipation information for lower output powers.

POWER SUPPLY BYPASSING

As with any power amplifier, proper supply bypassing is critical for low noise performance and high power supply rejection. The capacitor location on both the bypass and power supply pins should be as close to the device as possible. As displayed in the **Typical Performance Characteristics** section, the effect of a larger half supply bypass capacitor is improved low frequency THD + N due to increased half-supply stability. Typical applications employ a 5V regulator with 10 μ F and a 0.1 μ F bypass capacitors which aid in supply stability, but do not eliminate the need for bypassing the supply nodes of the LM4861. The selection of bypass capacitors, especially C_B , is thus dependant upon desired low frequency THD + N, system cost, and size constraints.

SHUTDOWN FUNCTION

In order to reduce power consumption while not in use, the LM4861 contains a shutdown pin to externally turn off the amplifier's bias circuitry. The shutdown feature turns the amplifier off when a logic high is placed on the shutdown pin. Upon going into shutdown, the output is immediately disconnected from the speaker. There is a built-in threshold which produces a drop in quiescent current to 500 μ A typically. For a 5V power supply, this threshold occurs when 2V-3V is applied to the shutdown pin. A typical quiescent current of 0.6 μ A results when the supply voltage is applied to the shutdown pin. In many applications, a microcontroller or microprocessor output is used to control the shutdown circuitry which provides a quick, smooth transition into shutdown. Another solution is to use a single-pole, single-throw switch that when closed, is connected to ground and enables the amplifier. If the switch is open, then a soft pull-up resistor of 47 k Ω will disable the LM4861. There are no soft pull-down resistors inside the LM4861, so a definite shutdown pin voltage must be applied externally, or the internal logic gate will be left floating which could disable the amplifier unexpectedly.



Application Information (Continued)

HIGHER GAIN AUDIO AMPLIFIER

The LM4861 is unity-gain stable and requires no external components besides gain-setting resistors, an input coupling capacitor, and proper supply bypassing in the typical application. However, if a closed-loop differential gain of greater than 10 is required, then a feedback capacitor is needed, as shown in *Figure 2*, to bandwidth limit the amplifier. This feedback capacitor creates a low pass filter that eliminates unwanted high frequency oscillations. Care should be taken when calculating the -3 dB frequency in that an incorrect combination of R_f and C_f will cause rolloff before 20 kHz. A typical combination of feedback resistor and capacitor that will not produce audio band high frequency rolloff is $R_f = 100$ k Ω and $C_f = 5$ pF. These components result in a -3 dB point of approximately 320 kHz. Once the differential gain of the amplifier has been calculated, a choice of R_f will result, and C_f can then be calculated from the formula stated in the **External Components Description** section.

VOICE-BAND AUDIO AMPLIFIER

Many applications, such as telephony, only require a voice-band frequency response. Such an application usually requires a flat frequency response from 300 Hz to 3.5 kHz. By adjusting the component values of *Figure 2*, this common application requirement can be implemented. The combination of R_i and C_i form a highpass filter while R_f and C_f form a lowpass filter. Using the typical voice-band frequency range, with a passband differential gain of approximately 100, the following values of R_i , C_i , R_f , and C_f follow from the equations stated in the **External Components Description** section.

$$R_i = 10 \text{ k}\Omega, R_f = 510 \text{ k}\Omega, C_i = 0.22 \text{ }\mu\text{F}, \text{ and } C_f = 15 \text{ pF}$$

Five times away from a -3 dB point is 0.17 dB down from the flatband response. With this selection of components, the resulting -3 dB points, f_L and f_H , are 72 Hz and 20 kHz, respectively, resulting in a flatband frequency response of better than ± 0.25 dB with a rolloff of 6 dB/octave outside of the passband. If a steeper rolloff is required, other common bandpass filtering techniques can be used to achieve higher order filters.

SINGLE-ENDED AUDIO AMPLIFIER

Although the typical application for the LM4861 is a bridged monoaural amp, it can also be used to drive a load single-endedly in applications, such as PC cards, which require that one side of the load is tied to ground. *Figure 3* shows a common single-ended application, where V_{O1} is used to drive the speaker. This output is coupled through a 470 μF capacitor, which blocks the half-supply DC bias that exists in all single-supply amplifier configurations. This capacitor, designated C_O in *Figure 3*, in conjunction with R_L , forms a highpass filter. The -3 dB point of this high pass filter is $1/(2\pi R_L C_O)$, so care should be taken to make sure that the product of R_L and C_O is large enough to pass low frequencies to the load. When driving an 8 Ω load, and if a full audio spectrum reproduction is required, C_O should be at least 470 μF . V_{O2} , the output that is not used, is connected through a 0.1 μF capacitor to a 2 k Ω load to prevent instability. While such an instability will not affect the waveform of V_{O1} , it is good design practice to load the second output.

AUDIO POWER AMPLIFIER DESIGN

Design a 500 mW / 8 Ω Audio Amplifier

Given:

Power Output	500 mWrms
Load Impedance	8 Ω
Input Level	1 Vrms(max)
Input Impedance	20 k Ω
Bandwidth	20 Hz–20 kHz \pm 0.25 dB

A designer must first determine the needed supply rail to obtain the specified output power. Calculating the required supply rail involves knowing two parameters, V_{opeak} and also the dropout voltage. The latter is typically 0.7V. V_{opeak} can be determined from equation 3.

$$V_{\text{opeak}} = \sqrt{(2R_L P_O)} \quad (3)$$

For 500 mW of output power into an 8 Ω load, the required V_{opeak} is 2.83V. A minimum supply rail of 3.53V results from adding V_{opeak} and V_{od} . But 3.53V is not a standard voltage that exists in many applications and for this reason, a supply rail of 5V is designated. Extra supply voltage creates dynamic headroom that allows the LM4861 to reproduce peaks in excess of 500 mW without clipping the signal. At this time, the designer must make sure that the power supply choice along with the output impedance does not violate the conditions explained in the **Power Dissipation** section.

Once the power dissipation equations have been addressed, the required differential gain can be determined from Equation 4.

$$A_{\text{vd}} \geq 2 * \sqrt{(P_O R_L)} / (V_{\text{IN}}) = V_{\text{orms}} / V_{\text{inrms}} \quad (4)$$

$$R_f / R_i = A_{\text{vd}} / 2 \quad (5)$$

From equation 4, the minimum A_{vd} is: $A_{\text{vd}} = 2$

Since the desired input impedance was 20 k Ω , and with a A_{vd} of 2, a ratio of 1:1 of R_f to R_i results in an allocation of $R_i = R_f = 20$ k Ω . Since the A_{vd} was less than 10, a feedback capacitor is not needed. The final design step is to address the bandwidth requirements which must be stated as a pair of -3 dB frequency points. Five times away from a -3 dB point is 0.17 dB down from passband response which is better than the required ± 0.25 dB specified. This fact results in a low and high frequency pole of 4 Hz and 100 kHz respectively. As stated in the **External Components** section, R_i in conjunction with C_i create a highpass filter.

$$C_i \geq 1 / (2\pi * 20 \text{ k}\Omega * 4 \text{ Hz}) = 1.98 \text{ }\mu\text{F}; \text{ use } 2.2 \text{ }\mu\text{F}.$$

The high frequency pole is determined by the product of the desired high frequency pole, f_H , and the differential gain, A_{vd} . With a $A_{\text{vd}} = 2$ and $f_H = 100$ kHz, the resulting GBWP = 100 kHz which is much smaller than the LM4861 GBWP of 7 MHz. This figure displays that if a designer has a need to design an amplifier with a higher differential gain, the LM4861 can still be used without running into bandwidth problems.



Physical Dimensions inches (millimeters)

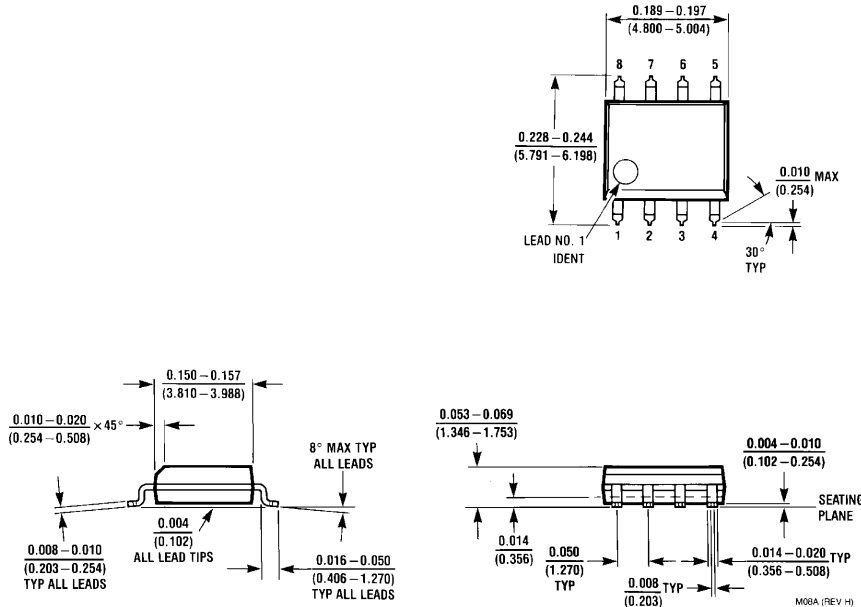

8-Lead (0.150" Wide) Molded Small Outline Package, JEDEC (M)
Order Number LM4861
NS Package Number M08A

LIFE SUPPORT POLICY

NATIONAL'S PRODUCTS ARE NOT AUTHORIZED FOR USE AS CRITICAL COMPONENTS IN LIFE SUPPORT DEVICES OR SYSTEMS WITHOUT THE EXPRESS WRITTEN APPROVAL OF THE PRESIDENT OF NATIONAL SEMICONDUCTOR CORPORATION. As used herein:

1. Life support devices or systems are devices or systems which, (a) are intended for surgical implant into the body, or (b) support or sustain life, and whose failure to perform, when properly used in accordance with instructions for use provided in the labeling, can be reasonably expected to result in a significant injury to the user.
2. A critical component is any component of a life support device or system whose failure to perform can be reasonably expected to cause the failure of the life support device or system, or to affect its safety or effectiveness.



National Semiconductor Corporation
 2900 Semiconductor Drive
 P.O. Box 58090
 Santa Clara, CA 95052-8090
 Tel: 1(800) 272-9959
 TWX: (910) 339-9240

National Semiconductor GmbH
 Livry-Gargan-Str. 10
 D-82256 Fürstenfeldbruck
 Germany
 Tel: (81-41) 35-0
 Telex: 527649
 Fax: (81-41) 35-1

National Semiconductor Japan Ltd.
 Sumitomo Chemical
 Engineering Center
 Bldg. 7F
 1-7-1, Nakase, Mihama-Ku
 Chiba-City,
 Chiba Prefecture 261
 Tel: (043) 299-2300
 Fax: (043) 299-2500

National Semiconductor Hong Kong Ltd.
 13th Floor, Straight Block,
 Ocean Centre, 5 Canton Rd.
 Tsimshatsui, Kowloon
 Hong Kong
 Tel: (852) 2737-1600
 Fax: (852) 2736-9960

National Semiconductores Do Brazil Ltda.
 Rue Deputado Lacorda Franco
 120-3A
 Sao Paulo-SP
 Brazil 05418-000
 Tel: (55-11) 212-5066
 Telex: 391-1131931 NSBR BR
 Fax: (55-11) 212-1181

National Semiconductor (Australia) Pty, Ltd.
 Building 16
 Business Park Drive
 Monash Business Park
 Nottingham, Melbourne
 Victoria 3168 Australia
 Tel: (3) 558-9999
 Fax: (3) 558-9998

National does not assume any responsibility for use of any circuitry described, no circuit patent licenses are implied and National reserves the right at any time without notice to change said circuitry and specifications.