

SHINDENGEN

Power Switching Regulators

MA4000 Series

MA4810

OUTLINE DIMENSIONS

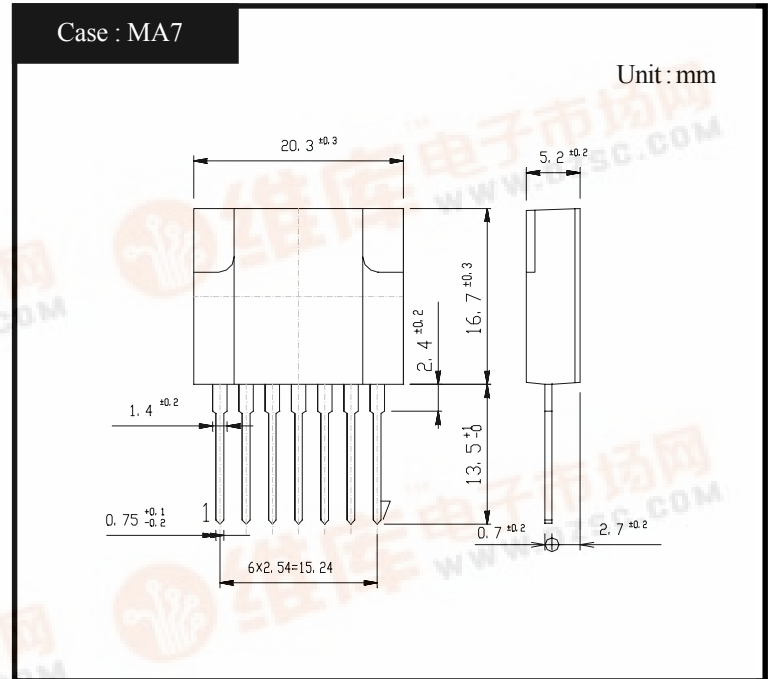

RATINGS

● Absolute Maximum Ratings

Item	Symbol	Conditions	Ratings	Unit
Storage Temperature	Tstg		-30~125	°C
Operating Temperature	Top		-20~125	°C
Junction Temperature	Tj		150	°C
Peak Input Voltage	Vin	②+,③-,⑤-	800	V
Input Current	Iin	DC ②+,③-	3	A
		Pulse ②+,③- Duty 1/2	6	A
Maximum Power Dissipation	PD	Ta=25°C	3	W
		Heatsink Tc=100°C	17	W
Dielectric Strength	Vdis	Terminals To Case AC 1 min	2	kV
Insulation Resistance		Terminals To Case 500VDC	100	MΩ
Max Voltage ④ to ⑥	V④•⑥	④+,⑥-	6	V
Max Current ⑥ to ④	I⑥•④	⑥+,④- (Peak) Duty Max 1/2	200	mA
Reverse Current	Iz	⑤+,④-	MAX 20	mA

● Electrical Characteristics (Tc=25°C)

Item	Symbol	Conditions	Ratings	Unit	
Q1	Zero Gate Voltage Drcain Current	Idss	VDS=800V, VGS=0V, ②+,③-	MAX 250	μA
				TYP (4.1)	Ω
Q1	Static Drain-Source On-State Resistance	RDS(on)	IB=1.5A, ②+,③- VGS=10V, ⑤+,③-	MAX 5.0	Ω
			Thermal Resistance	θjc	Junction to Case
D1	Reverse Current	IR	VR=800V, ①+,②-	MAX 10	μA
	Forward Voltage	VF	IF=0.6A, ②+,①-	MAX 1.7	V
Q2	Fold Back Detection Voltage		③+,④-	TYP 0.7	V



●Standard Operating Condition•Design Standard For Application Circuit

Item	Conditions	Ratings	Unit
Input Rated Voltage		AC90~276	V
Output Nominal Voltage		12	V
Output Nominal Current		2.5	A

●Standard Operating Condition•Standard Operating Characteristics (Ta=25°C)

Item	Conditions	Ratings	Unit		
Minimum Input Full Load Output Voltage	Vin=90V, I _O =2.5A	12.0±0.6	V	Fig 1, ① Refer	
Maximum Input Light Load Output Voltage	Vin=276V, I _O =0.25A	12.0±0.6	V	Fig 1, ② Refer	
Over Current Protection	Foldback Current	Vin=276V, V _O =10V	MAX 3.8	A	Fig 1, ③ Refer
	Short Circuit	Vin=276V, R _O =0.5 Ω	Nodamage To Any Device, Automatic Recovery.	-	Fig 1, ④ Refer

Figure in ○=Terminal Sign

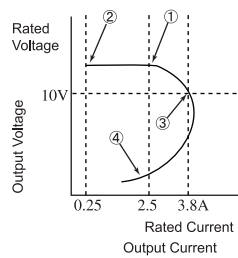
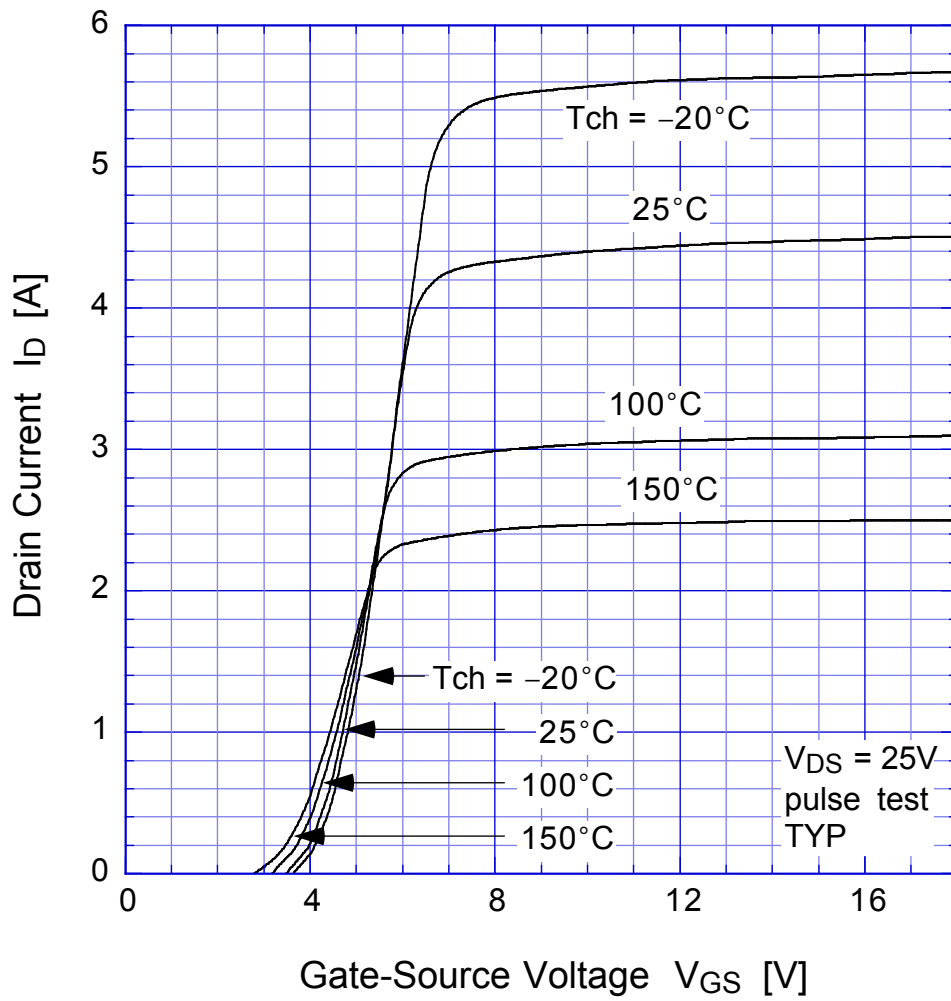

Fig1. Output Voltage/Current



MA4810

Transfer Characteristics



MA4810 Static Drain-Source On-state Resistance

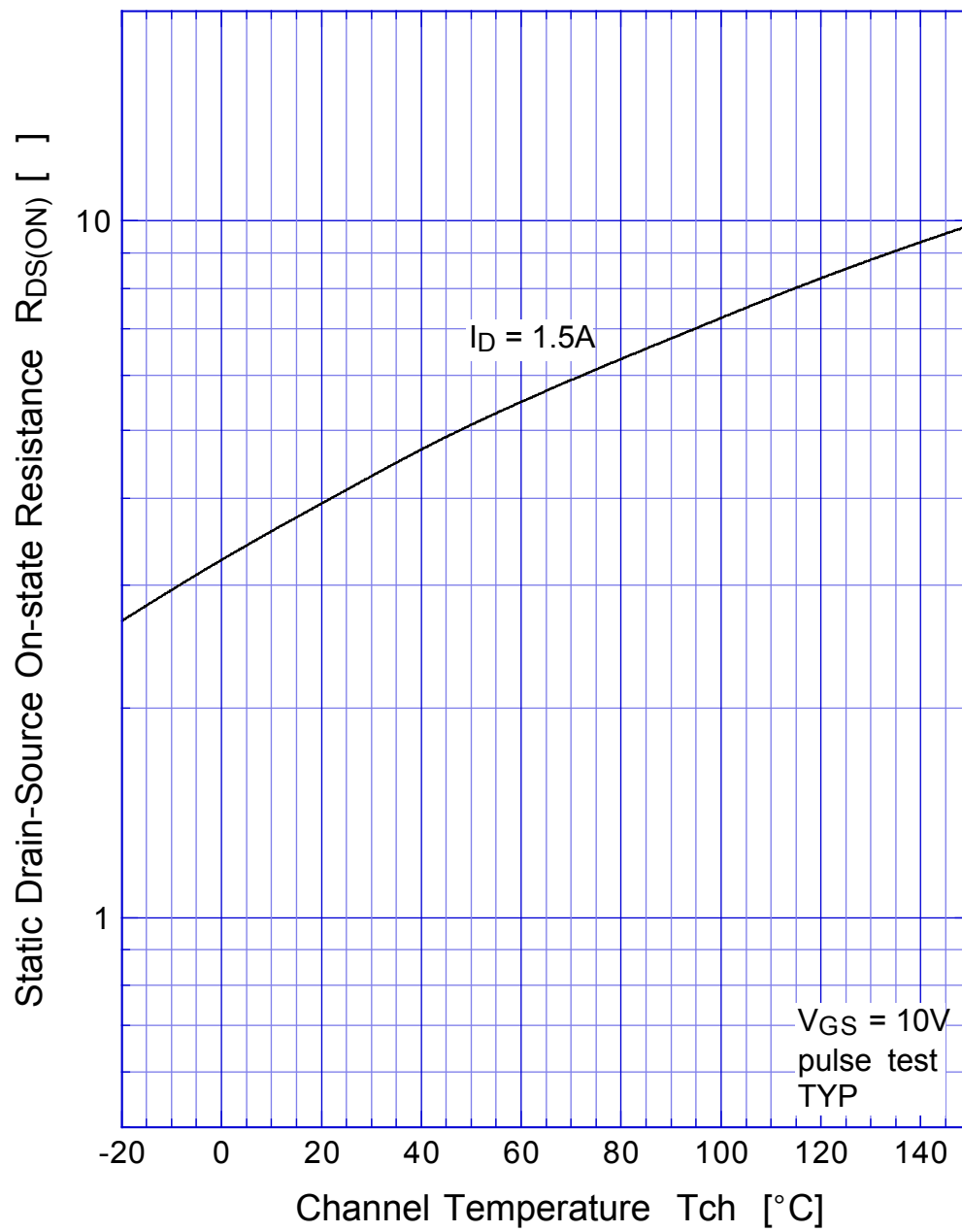

MA4810 Gate Threshold Voltage

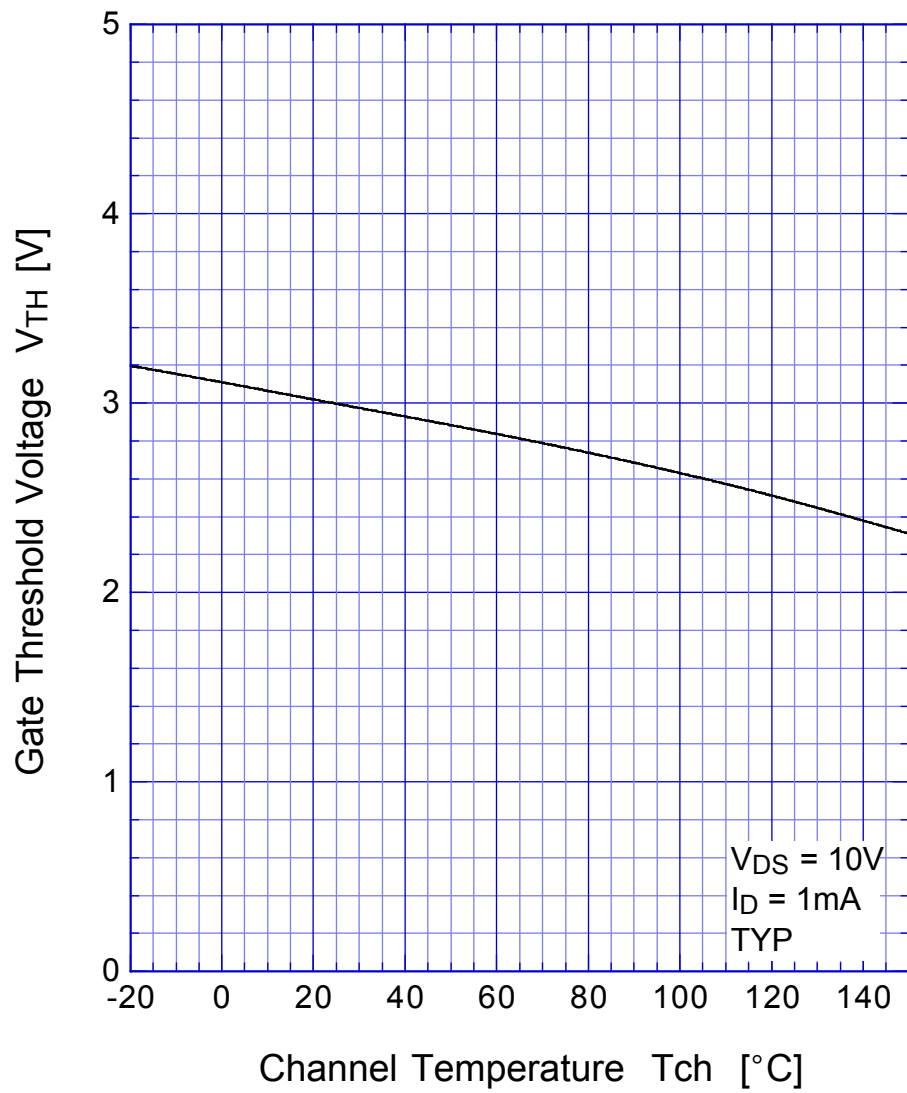

MA4810

Capacitance

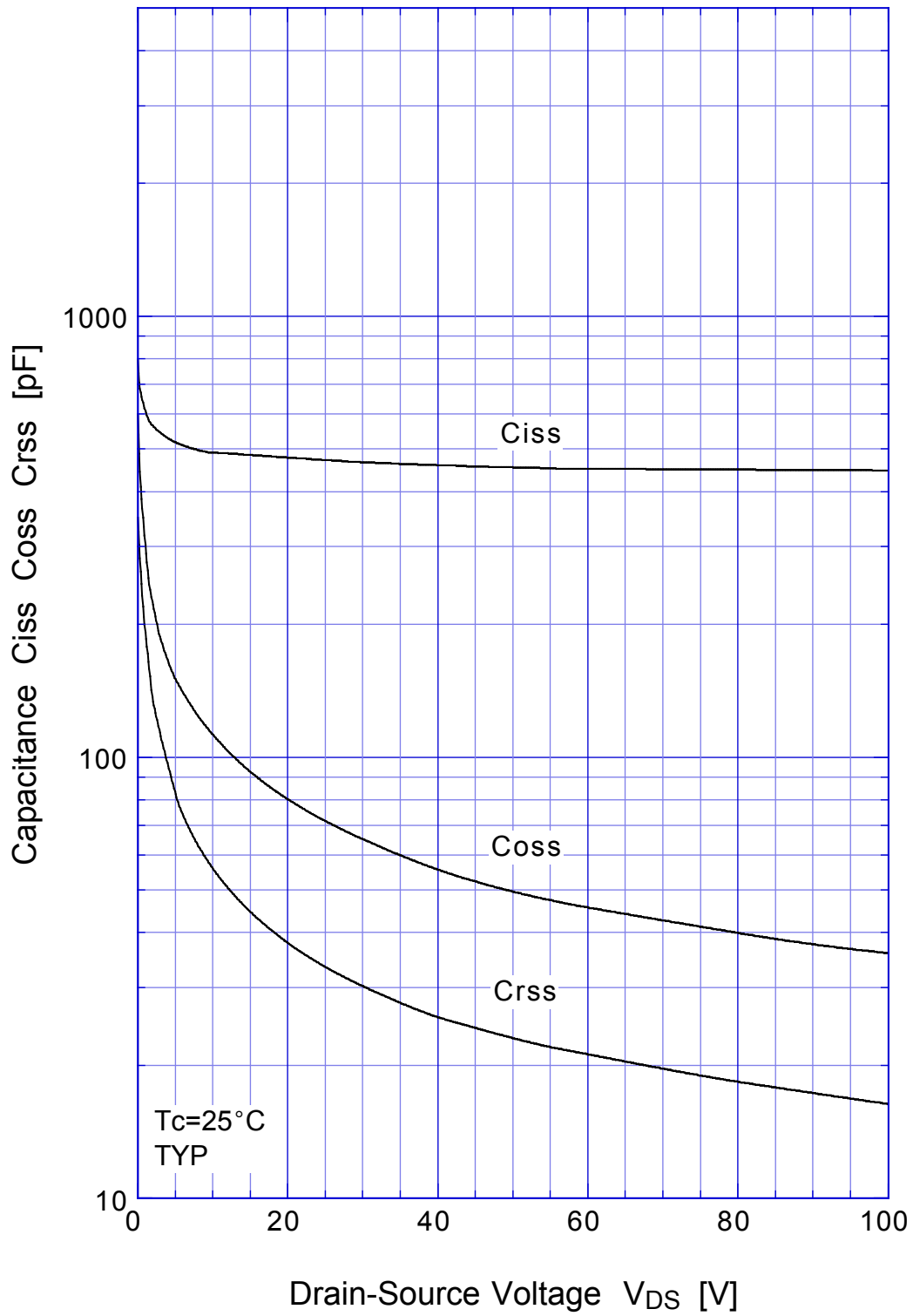



MA4810 Transient Thermal Impedance

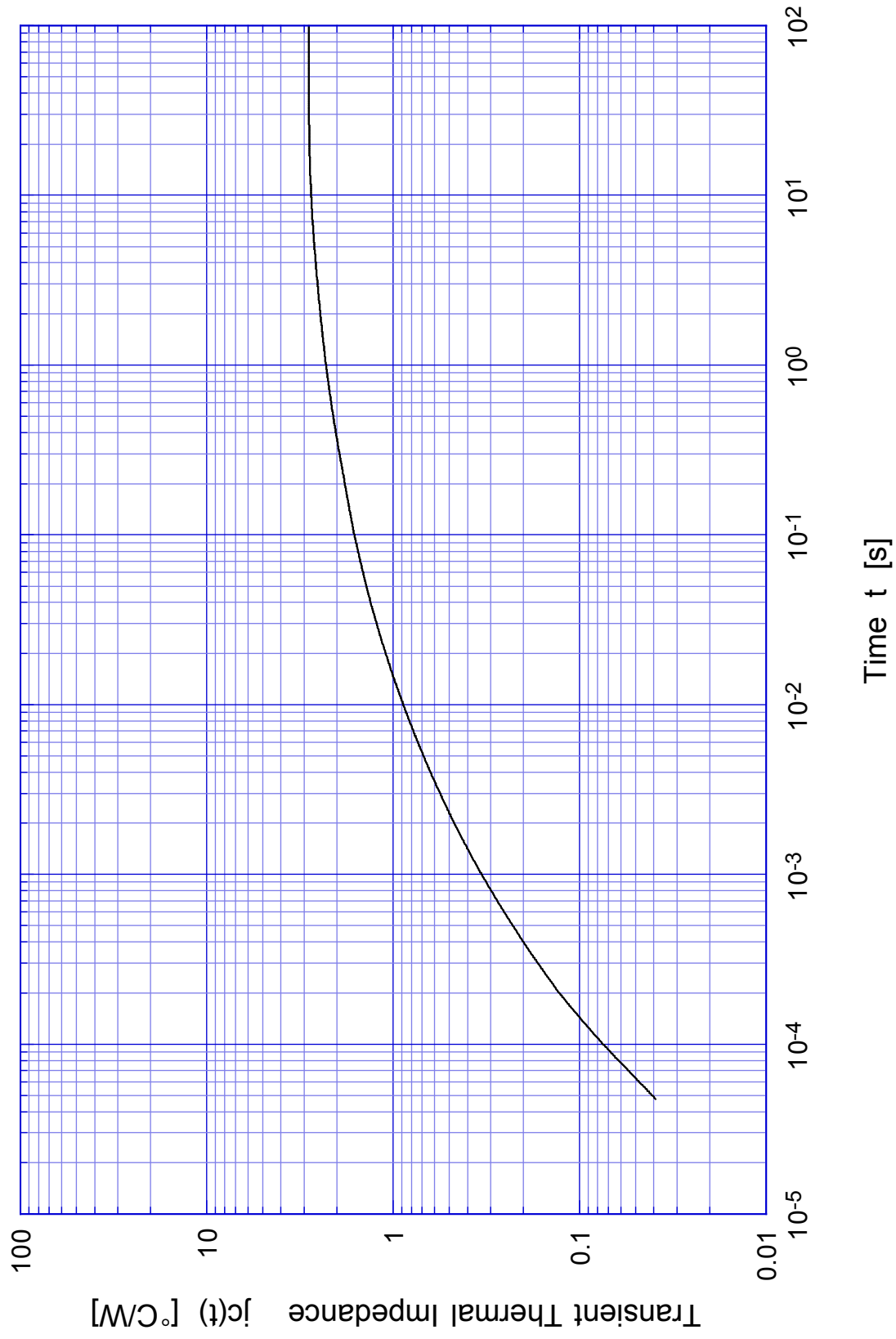

MA4810

Safe Operating Area

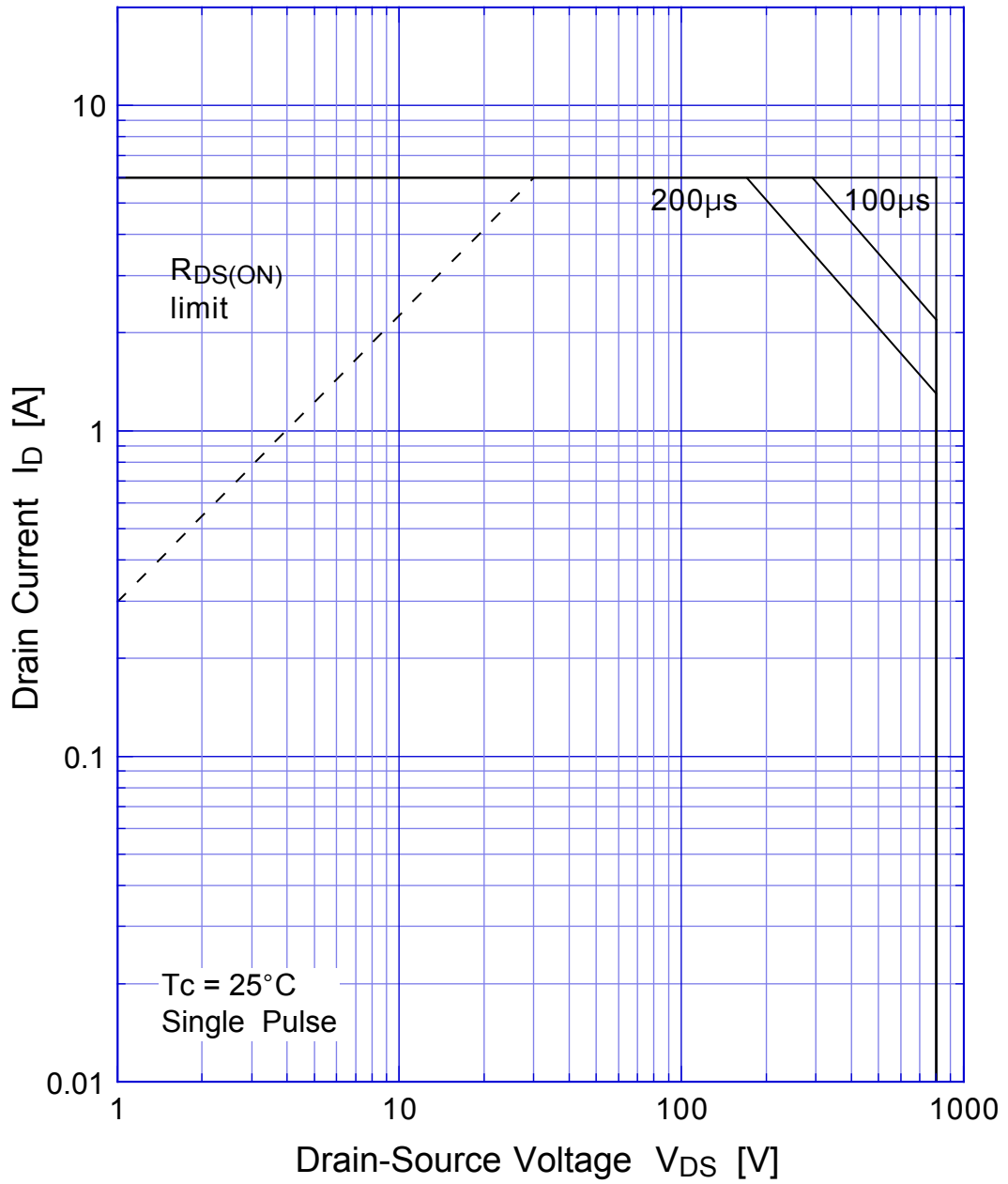

MA4810

Power Derating

