



50 MHz to 2200 MHz Quadrature Modulator

ADL5385

FEATURES

- Output frequency range:** 50 MHz to 2200 MHz
- 1 dB output compression:** 11 dBm @ 350 MHz
- Noise floor:** -159 dBm/Hz @ 350 MHz
- Sideband suppression:** -50 dBc @ 350 MHz
- Carrier feedthrough:** -46 dBm @ 350 MHz
- Single supply:** 4.75 V to 5.5 V
- 24-lead, Pb-free LFCSP_VQ with exposed paddle**

APPLICATIONS

- Radio-link infrastructure**
- Cable modem termination systems**
- Wireless infrastructure systems**
- Wireless local loop**
- WiMAX/broadband wireless access systems**

PRODUCT DESCRIPTION

The ADL5385 is a silicon, monolithic, quadrature modulator designed for use from 50 MHz to 2200 MHz. Its excellent phase accuracy and amplitude balance enable both high performance intermediate frequency (IF) and direct radio frequency (RF) modulation for communication systems.

The AD5385 takes the signals from two differential baseband inputs and modulates them onto two carriers in quadrature with each other. The two internal carriers are derived from a single-ended, external local oscillator input signal at twice the frequency as the desired carrier output. The two modulated signals are summed together in a differential-to-single-ended amplifier designed to drive 50 Ω loads.

FUNCTIONAL BLOCK DIAGRAM

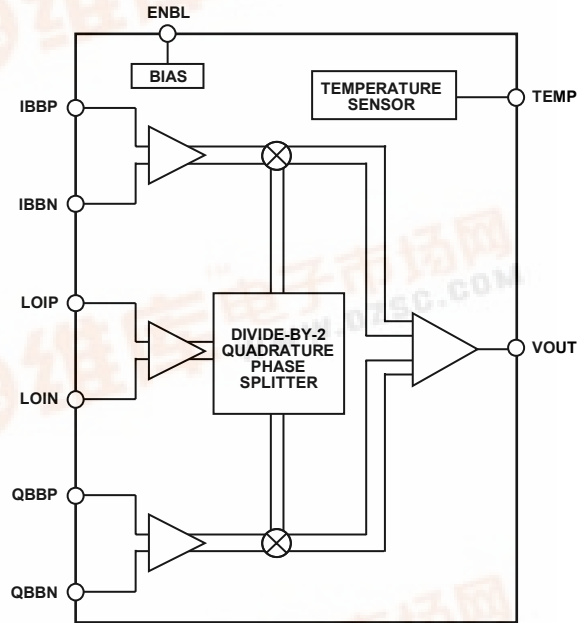

Figure 1.

The ADL5385 can be used as either an IF or a direct-to-RF modulator in digital communication systems. The wide baseband input bandwidth allows for either baseband drive or drive from a complex IF. Typical applications are in radio-link transmitters, cable modem termination systems, and broadband wireless access systems.

The ADL5385 is fabricated using the Analog Devices, Inc., advanced silicon germanium bipolar process and is packaged in a 24-lead, Pb-free LFCSP_VQ with exposed paddle. Performance is specified over -40°C to +85°C. A Pb-free evaluation board is also available.



TABLE OF CONTENTS

Features	1	Basic Connections	13
Applications.....	1	Optimization.....	13
Functional Block Diagram	1	Applications.....	15
Product Description.....	1	DAC Modulator Interfacing	15
Specifications.....	3	155 Mbps (STM-1) 128 QAM Transmitter.....	16
Absolute Maximum Ratings.....	6	CMTS Transmitter Application.....	16
ESD Caution.....	6	Spectral Products from Harmonic Mixing.....	17
Pin Configuration and Functional Descriptions.....	7	RF Second-Order Products.....	17
Typical Performance Characteristics	8	LO Generation Using PLLs.....	18
Circuit Description.....	12	Transmit DAC Options	18
Overview.....	12	Modulator/Demodulator Options	18
LO Interface.....	12	Evaluation Board.....	19
V-to-I Converter.....	12	Characterization Setup	21
Mixers	12	SSB Setup	21
D-to-S Amplifier.....	12	Outline Dimensions	22
Bias Circuit.....	12	Ordering Guide	22

REVISION HISTORY**10/06—Revision 0: Initial Version**

SPECIFICATIONS

Unless otherwise noted, $V_S = 5\text{ V}$; $T_A = 25^\circ\text{C}$; $LO = -7\text{ dBm}$; I/Q inputs = 1.4 V p-p differential sine waves in quadrature on a 500 mV dc bias; baseband frequency = 1 MHz; LO source and RF output load impedances are $50\ \Omega$.

Table 1.

Parameter	Conditions	Min	Typ	Max	Unit
OUTPUT FREQUENCY RANGE		50		2200	MHz
EXTERNAL LO FREQUENCY RANGE	External LO frequency is twice output frequency	100		4400	MHz
OUTPUT FREQUENCY = 50 MHz					
Output Power	Single (lower) sideband output	4	5.6	8	dBm
Output P1 dB			11		dBm
Carrier Feedthrough	Unadjusted (nominal drive level)		-57		dBm
	@ +85°C after optimization at +25°C		-67		dBm
	@ -40°C after optimization at +25°C		-67		dBm
Sideband Suppression	Unadjusted (nominal drive level)		-57		dBc
	@ +85°C after optimization at +25°C		-64		dBc
	@ -40°C after optimization at +25°C		-68		dBc
Second Baseband Harmonic	$(F_{LO} - (2 \times F_{BB}))$, $P_{OUT} = 5\text{ dBm}$		-83		dBc
Third Baseband Harmonic	$(F_{LO} + (3 \times F_{BB}))$, $P_{OUT} = 5\text{ dBm}$		-58		dBc
Output IP2	F1 = +3.5 MHz, F2 = +4.5 MHz, $P_{OUT} = -3\text{ dBm}$ per tone		69		dBm
Output IP3	F1 = +3.5 MHz, F2 = +4.5 MHz, $P_{OUT} = -3\text{ dBm}$ per tone		26		dBm
Quadrature Phase Error			-0.17		degrees
I/Q Amplitude Balance			-0.03		dB
Noise Floor	20 MHz offset from LO, all BB inputs at a bias of 500 mV		-155		dBm/Hz
	20 MHz offset from LO, output power = -5 dBm		-150		dBm/Hz
Output Return Loss			-19		dB
OUTPUT FREQUENCY = 140 MHz					
Output Power	Single (lower) sideband output		5.7		dBm
Output P1 dB			11		dBm
Carrier Feedthrough	Unadjusted (nominal drive level)		-52		dBm
	@ +85°C after optimization at +25°C		-66		dBm
	@ -40°C after optimization at +25°C		-67		dBm
Sideband Suppression	Unadjusted (nominal drive level)		-53		dBc
	@ +85°C after optimization at +25°C		-63		dBc
	@ -40°C after optimization at +25°C		-68		dBc
Second Baseband Harmonic	$(F_{LO} - (2 \times F_{BB}))$, $P_{OUT} = 5\text{ dBm}$		-83		dBc
Third Baseband Harmonic	$(F_{LO} + (3 \times F_{BB}))$, $P_{OUT} = 5\text{ dBm}$		-57		dBc
Output IP2	F1 = +3.5 MHz, F2 = +4.5 MHz, $P_{OUT} = -3\text{ dBm}$ per tone		70		dBm
Output IP3	F1 = +3.5 MHz, F2 = +4.5 MHz, $P_{OUT} = -3\text{ dBm}$ per tone		26		dBm
Quadrature Phase Error			-0.33		degrees
I/Q Amplitude Balance			-0.03		dB
Noise Floor	20 MHz offset from LO, all BB inputs at a bias of 500 mV		-160		dBm/Hz
Output Return Loss			-20		dB
OUTPUT FREQUENCY = 350 MHz					
Output Power	Single (lower) sideband output	3	5.6	7	dBm
Output P1 dB			11		dBm
Carrier Feedthrough	Unadjusted (nominal drive level)		-46		dBm
	@ +85°C after optimization at +25°C		-65		dBm
	@ -40°C after optimization at +25°C		-66		dBm
Sideband Suppression	Unadjusted (nominal drive level)		-50		dBc
	@ +85°C after optimization at +25°C		-63		dBc
	@ -40°C after optimization at +25°C		-61		dBc



ADL5385

Parameter	Conditions	Min	Typ	Max	Unit
Second Baseband Harmonic	$(F_{LO} - (2 \times F_{BB}))$, $P_{OUT} = 5$ dBm		-80		dBc
Third Baseband Harmonic	$(F_{LO} + (3 \times F_{BB}))$, $P_{OUT} = 5$ dBm		-53		dBc
Output IP2	F1 = 3.5 MHz, F2 = 4.5 MHz, $P_{OUT} = -3$ dBm per tone		71		dBm
Output IP3	F1 = 3.5 MHz, F2 = 4.5 MHz, $P_{OUT} = -3$ dBm per tone		26		dBm
Quadrature Phase Error			0.39		degrees
I/Q Amplitude Balance			-0.03		dB
Noise Floor	20 MHz offset from LO, all BB inputs at a bias of 500 mV		-159		dBm/Hz
	20 MHz offset from LO, output power = -5 dBm		-157		dBm/Hz
Output Return Loss			-21		dB
OUTPUT FREQUENCY = 860 MHz					
Output Power	Single (lower) sideband output	2.5	5.3	6.5	dBm
Output P1 dB			11		dBm
Carrier Feedthrough	Unadjusted (nominal drive level)		-41	-35	dBm
	@ +85°C after optimization at +25°C		-63		dBm
	@ -40°C after optimization at +25°C		-65		dBm
Sideband Suppression	Unadjusted (nominal drive level)		-41	-35	dBc
	@ +85°C after optimization at +25°C		-58		dBc
	@ -40°C after optimization at +25°C		-59		dBc
Second Baseband Harmonic	$(F_{LO} - (2 \times F_{BB}))$, $P_{OUT} = 5$ dBm		-73	-57	dBc
Third Baseband Harmonic	$(F_{LO} + (3 \times F_{BB}))$, $P_{OUT} = 5$ dBm		-50	-45	dBc
Output IP2	F1 = +3.5 MHz, F2 = +4.5 MHz, $P_{OUT} = -3$ dBm per tone		70		dBm
Output IP3	F1 = +3.5 MHz, F2 = +4.5 MHz, $P_{OUT} = -3$ dBm per tone		25		dBm
Quadrature Phase Error			0.67		degrees
I/Q Amplitude Balance			-0.03		dB
Noise Floor	20 MHz offset from LO, all BB inputs at a bias of 500 mV		-159		dBm/Hz
	20 MHz offset from LO, output power = -5 dBm		-157		dBm/Hz
Output Return Loss			-19		dB
OUTPUT FREQUENCY = 1450 MHz					
Output Power	Single (lower) sideband output		4.4		dBm
Output P1 dB			10		dBm
Carrier Feedthrough	Unadjusted (nominal drive level)		-36		dBm
	@ +85°C after optimization at +25°C		-50		dBm
	@ -40°C after optimization at +25°C		-50		dBm
Sideband Suppression	Unadjusted (nominal drive level)		-44		dBc
	@ +85°C after optimization at +25°C		-61		dBc
	@ -40°C after optimization at +25°C		-51		dBc
Second Baseband Harmonic	$(F_{LO} - (2 \times F_{BB}))$, $P_{OUT} = 4$ dBm		-64		dBc
Third Baseband Harmonic	$(F_{LO} + (3 \times F_{BB}))$, $P_{OUT} = 4$ dBm		-52		dBc
Output IP2	F1 = 3.5 MHz, F2 = 4.5 MHz, $P_{OUT} = -3$ dBm per tone		63		dBm
Output IP3	F1 = 3.5 MHz, F2 = 4.5 MHz, $P_{OUT} = -3$ dBm per tone		24		dBm
Quadrature Phase Error			0.42		degrees
I/Q Amplitude Balance			-0.02		dB
Noise Floor	20 MHz offset from LO, all BB inputs at a bias of 500 mV		-160		dBm/Hz
Output Return Loss			-33		dB
OUTPUT FREQUENCY = 1900 MHz					
Output Power	Single (lower) sideband output		3.4		dBm
Output P1 dB			9		dBm
Carrier Feedthrough	Unadjusted (nominal drive level)		-35		dBm
	@ +85°C after optimization at +25°C		-51		dBm
	@ -40°C after optimization at +25°C		-51		dBm
Sideband Suppression	Unadjusted (nominal drive level)		-33		dBc



Parameter	Conditions	Min	Typ	Max	Unit
Second Baseband Harmonic Third Baseband Harmonic Output IP2 Output IP3 Quadrature Phase Error I/Q Amplitude Balance Noise Floor Output Return Loss	@ +85°C after optimization at +25°C		-43		dBc
	@ -40°C after optimization at +25°C		-47		dBc
	($F_{LO} - (2 \times F_{BB})$), $P_{OUT} = 3$ dBm		-58		dBc
	($F_{LO} + (3 \times F_{BB})$), $P_{OUT} = 3$ dBm		-47		dBc
	F1 = +3.5 MHz, F2 = +4.5 MHz, $P_{OUT} = -3$ dBm per tone		57		dBm
	F1 = +3.5 MHz, F2 = +4.5 MHz, $P_{OUT} = -3$ dBm per tone		22		dBm
			2.6		degrees
			0.003		dB
	20 MHz offset from LO, all BB inputs at a bias of 500 mV		-160		dBm/Hz
	20 MHz offset from LO, output power = -5 dBm		-156		dBm/Hz
		-20		dB	
OUTPUT FREQUENCY = 2150 MHz					
Output Power	Single (lower) sideband output		2.6		dBm
Output P1 dB			8		dBm
Carrier Feedthrough	Unadjusted (nominal drive level)		-36		dBm
	@ +85°C after optimization at +25°C		-47		dBm
	@ -40°C after optimization at +25°C		-48		dBm
Sideband Suppression	Unadjusted (nominal drive level)		-37		dBc
Second Baseband Harmonic	($F_{LO} - (2 \times F_{BB})$), $P_{OUT} = 2.6$ dBm		-56		dBc
Third Baseband Harmonic	($F_{LO} + (3 \times F_{BB})$), $P_{OUT} = 2.6$ dBm		-45		dBc
Output IP2	F1 = +3.5 MHz, F2 = +4.5 MHz, $P_{OUT} = -3$ dBm per tone		54		dBm
Output IP3	F1 = +3.5 MHz, F2 = +4.5 MHz, $P_{OUT} = -3$ dBm per tone		21		dBm
Quadrature Phase Error			1.5		degrees
I/Q Amplitude Balance			< 0.05		dB
Noise Floor	20 MHz offset from LO, all BB inputs at a bias of 500 mV		-160		dBm/Hz
	20 MHz offset from LO, output power = -5 dBm		-156		dBm/Hz
Output Return Loss			-15		dB
LO INPUTS	Pin LOIP and Pin LOIN				
LO Drive Level	Characterization performed at typical level	-10	-7	+5	dBm
Input Impedance			50		Ω
Input Return Loss	350 MHz, LOIN ac-coupled to ground		-20		dB
BASEBAND INPUTS	Pin IBBP, Pin IBBN, Pin QBBP, Pin QBBN				
I and Q Input Bias Level			500		mV
Input Bias Current			-70		μ A
Bandwidth (0.1 dB)	RF = 500 MHz, output power = 0 dBm		80		MHz
Bandwidth (3 dB)	RF = 500 MHz, output power = 0 dBm		>500		MHz
ENABLE INPUT	ENBL				
Turn-On Settling Time	ENBL = high (for output to within 0.5 dB of final value)		1.0		μ s
Turn-Off Settling Time	ENBL = low (at supply current falling below 20 mA)		1.4		μ s
ENBL High Level (Logic 1)		1.5			V
ENBL Low Level (Logic 0)				0.4	V
TEMPERATURE OUTPUT	TEMP				
Output Voltage	$T_A = 27.15^\circ\text{C}$, 300K, $R_L = 1$ M Ω (after full warmup)		1.56		V
Temperature Slope	$-40^\circ\text{C} \leq T_A \leq +85^\circ\text{C}$, $R_L = 1$ M Ω		4.6		mV/ $^\circ\text{C}$
Output Impedance			1.0		k Ω
POWER SUPPLIES	Pin VPS1 and Pin VPS2				
Voltage		4.75		5.5	V
Supply Current	ENBL = high		215	240	mA
	ENBL = low		80		μ A



ABSOLUTE MAXIMUM RATINGS

Table 2.

Parameter	Rating
Supply Voltage VPOS	5.5 V
IBBP, IBBN, QBBP, QBBN Range	0 V to 2.0 V
LOIP and LOIN	13 dBm
Internal Power Dissipation	1.375 W
θ_{JA} (Exposed Paddle Soldered Down)	58°C/W
Maximum Junction Temperature	164°C
Operating Temperature Range	-40°C to +85°C
Storage Temperature Range	-65°C to +150°C

Stresses above those listed under Absolute Maximum Ratings may cause permanent damage to the device. This is a stress rating only; functional operation of the device at these or any other conditions above those indicated in the operational section of this specification is not implied. Exposure to absolute maximum rating conditions for extended periods may affect device reliability.

ESD CAUTION



ESD (electrostatic discharge) sensitive device. Charged devices and circuit boards can discharge without detection. Although this product features patented or proprietary protection circuitry, damage may occur on devices subjected to high energy ESD. Therefore, proper ESD precautions should be taken to avoid performance degradation or loss of functionality.

PIN CONFIGURATION AND FUNCTIONAL DESCRIPTIONS

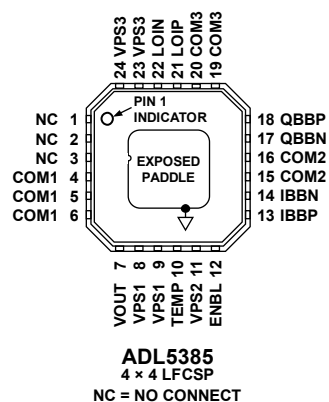

Figure 2. Pin Configuration

Table 3. Pin Function Descriptions

Pin No.	Mnemonic	Description
1, 2, 3	NC	No Connection. These pins can be left open or tied to ground.
4, 5, 6, 15, 16, 19, 20	COM1, COM2, COM3	Power Supply Common Pins. COM1, COM2, and COM3 must all be connected to a ground plane via a low impedance path.
7	VOUT	Device Output. Single-ended, 50 Ω internally biased RF/IF output; pin must be ac-coupled to the load.
8, 9, 11, 23, 24	VPS1, VPS2, VPS3	Power Supply Pins. Decouple each pin with a 0.1 μ F capacitor; Pin 8 and Pin 9 can share a single capacitor, as can Pin 23 and Pin 24. All pins must be connected to the same supply (V_s).
10	TEMP	Temperature Sensor Output. Provides dc voltage proportional to die temperature. Slope is 4.6 mV/ $^{\circ}$ C
12	ENBL	Device Enable. Shuts device down when grounded and enables device when pulled to supply voltage.
13, 14, 17, 18	IBBP, IBBN, QBPN, QBPN	Differential In-Phase and Quadrature Baseband Inputs. These high impedance inputs must be externally dc-biased to 500 mV dc and driven from a low impedance source. Nominal characterized ac signal swing is 700 mV p-p on each pin (150 mV to 850 mV). This results in a differential drive of 1.4V p-p with a 500 mV dc bias.
21	LOIP	Single-Ended Two-Times Local Oscillator Input. This input is internally biased and must be ac-coupled to the LO source.
22	LOIN	Common for LO Input. Must be ac-coupled to ground through a low impedance path.



TYPICAL PERFORMANCE CHARACTERISTICS

Unless otherwise noted, $V_S = 5\text{ V}$; $T_A = 25^\circ\text{C}$; $LO = -7\text{ dBm}$; I/Q inputs = 1.4 V p-p differential sine waves in quadrature on a 500 mV dc bias; baseband frequency = 1 MHz; LO source and RF output load impedances are $50\ \Omega$.

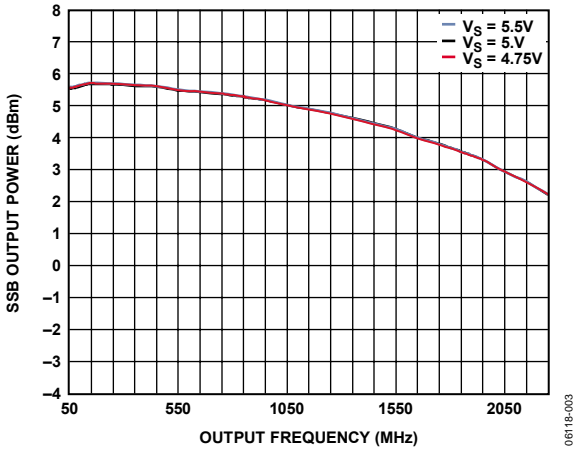

Figure 3. Single Sideband (SSB) Output Power (P_{out}) vs. Output Frequency and Power Supply

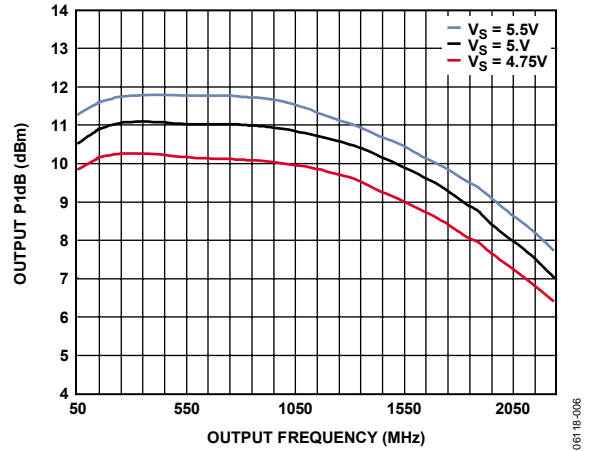

Figure 6. Output 1 dB Compression Point (OP_{1dB}) vs. Output Frequency and Power Supply

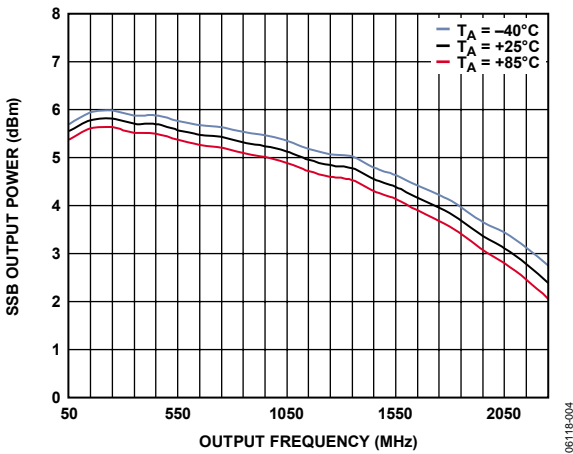

Figure 4. Single Sideband (SSB) Output Power (P_{out}) vs. Output Frequency and Temperature

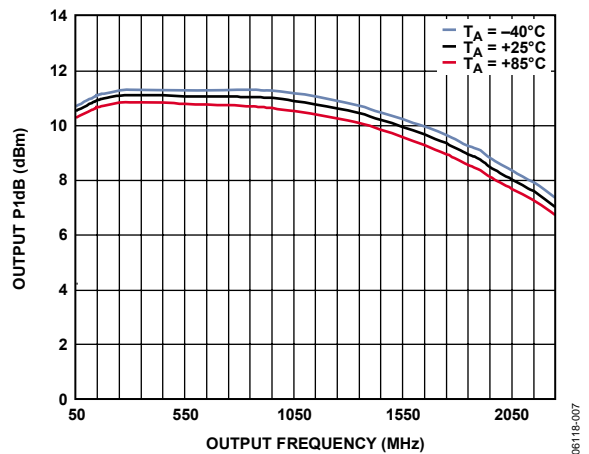

Figure 7. Output 1 dB Compression Point (OP_{1dB}) vs. Output Frequency and Temperature

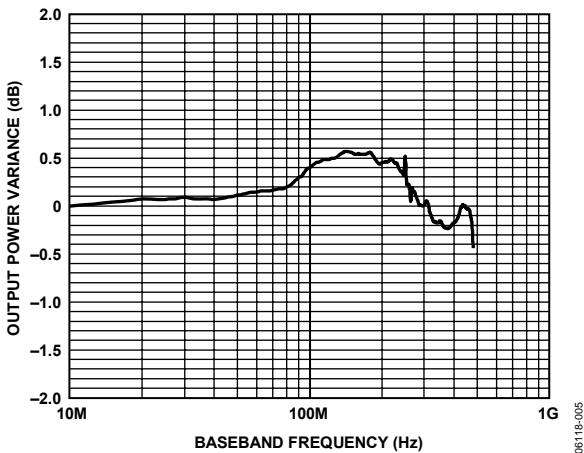

Figure 5. Baseband Frequency Response Normalized to Response for 1 MHz BB Signal; Carrier Frequency = 500 MHz

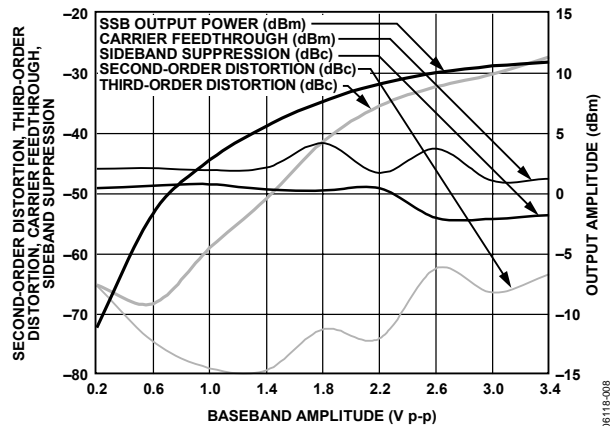

Figure 8. SSB Output Power, Second- and Third-Order Distortion, Carrier Feedthrough and Sideband Suppression vs. Differential Baseband Input Level; Output Frequency = 350 MHz



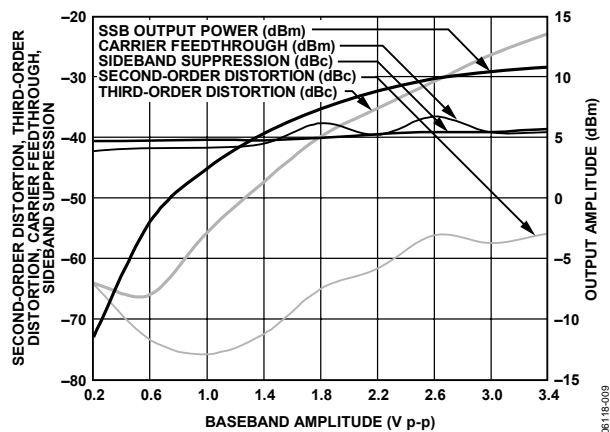

Figure 9. SSB Output Power, Second- and Third-Order Distortion, Carrier Feedthrough and Sideband Suppression vs. Baseband Single-Ended Input Level; Output Frequency = 860 MHz

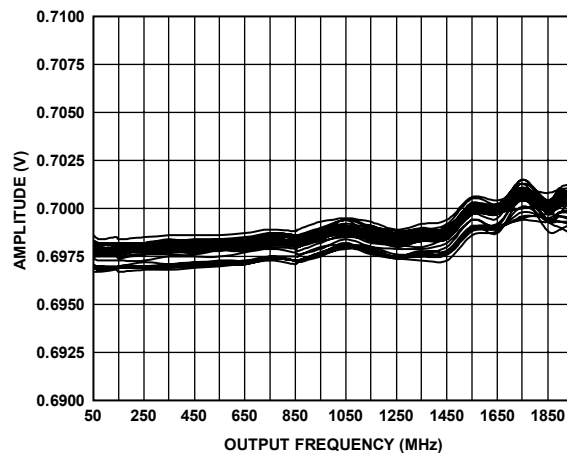

Figure 12. Distribution of Peak Q Amplitude to Null Undesired Sideband (Peak I Amplitude Held Constant at 0.7 V)

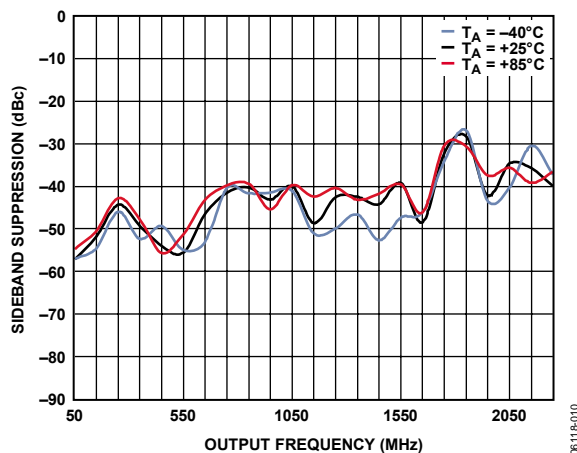

Figure 10. Sideband Suppression vs. Output Frequency and Temperature

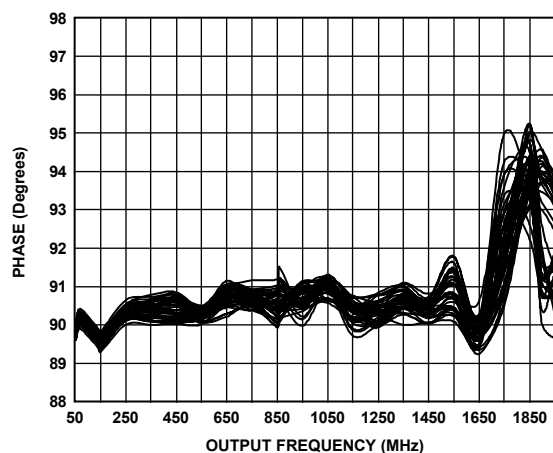

Figure 13. Distribution of IQ Phase to Null Undesired Sideband

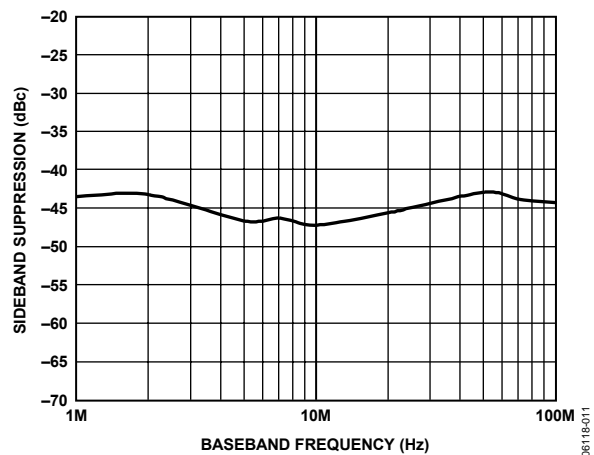

Figure 11. Sideband Suppression vs. Baseband Frequency; Output Frequency = 350 MHz

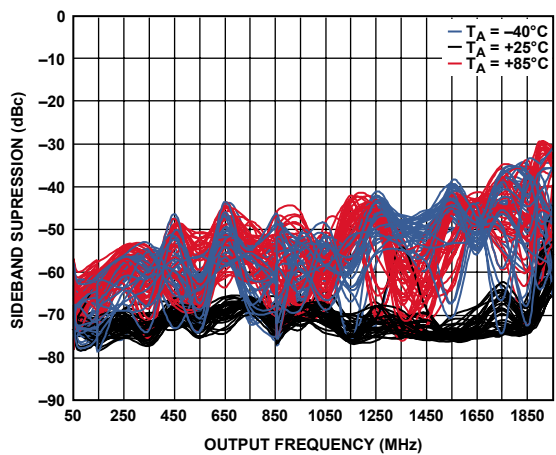

Figure 14. Sideband Suppression Distribution at Temperature Extremes, After Sideband Suppression Nulled to < -50 dBc at TA = +25°C



ADL5385

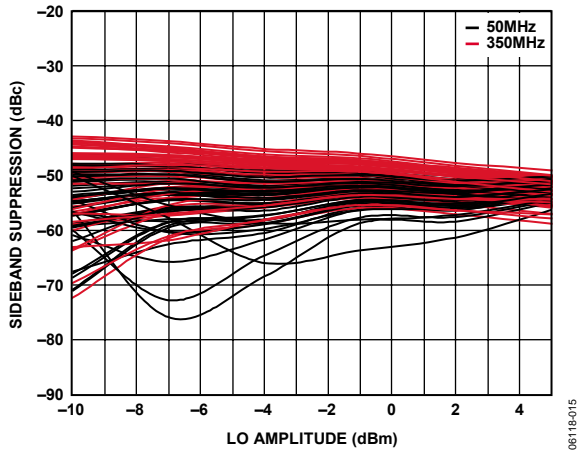

Figure 15. Distribution of Sideband Suppression vs. LO Input Power at 50 MHz and 350 MHz

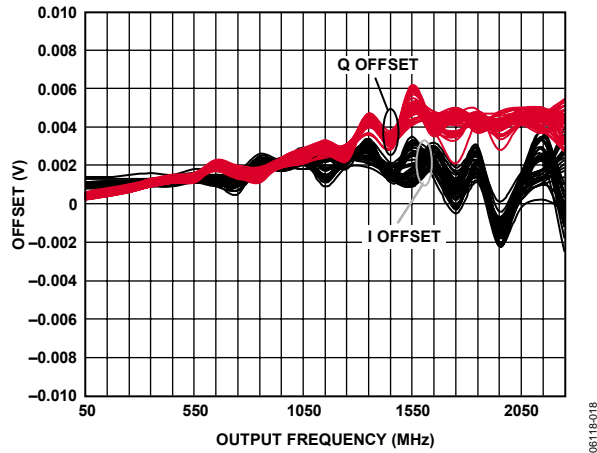

Figure 18. Distribution of I and Q Offset Required to Null Carrier Feedthrough

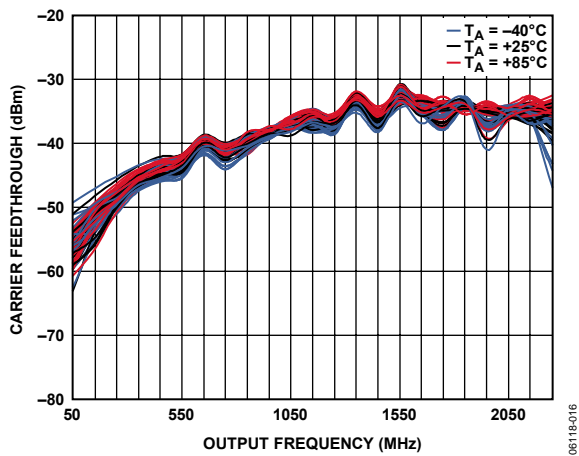

Figure 16. Distribution Carrier Feedthrough vs. Output Frequency and Temperature

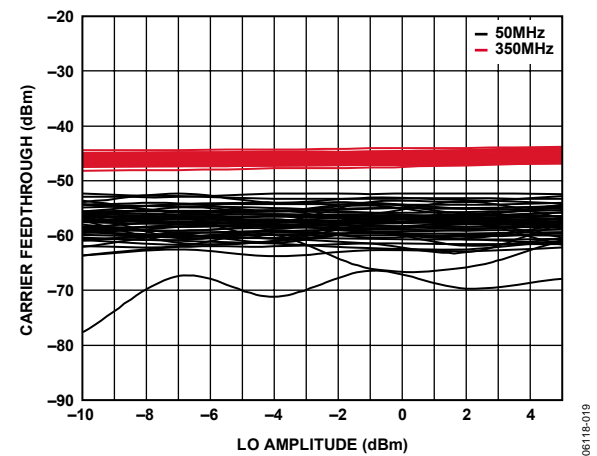

Figure 19. Distribution Carrier Feedthrough vs. LO Input Power at 50 MHz and 350 MHz

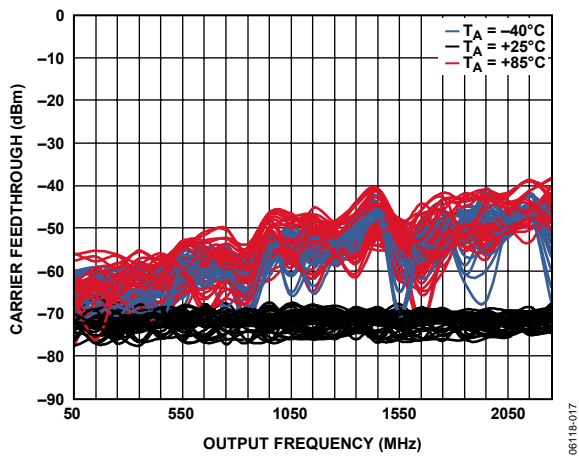

Figure 17. Carrier Feedthrough Distribution at Temperature Extremes, After Nulling to -65 dBm at $T_A = +25^\circ\text{C}$

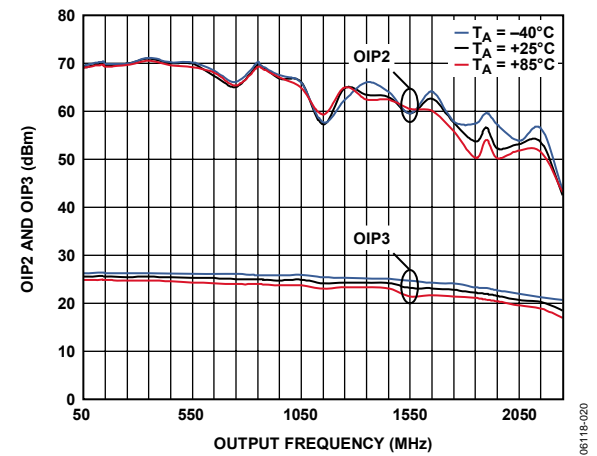

Figure 20. OIP3 and OIP2 vs. Output Frequency and Temperature



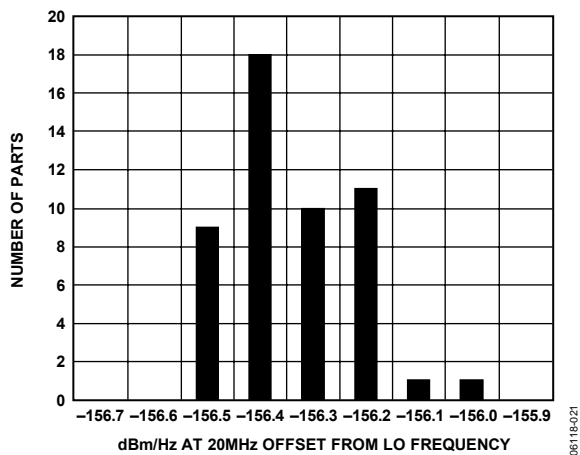

Figure 21. 20 MHz Offset Noise Floor Distribution, Output Frequency = 350 MHz, $P_{OUT} = -5$ dBm, QPSK Carrier, Symbol Rate = 3.84 MSPS

06118-021

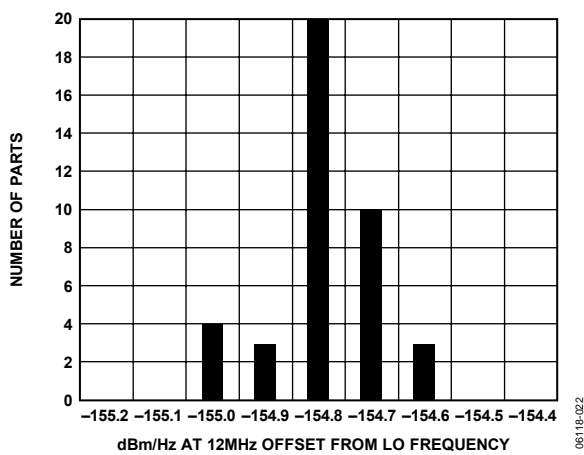

Figure 22. 12 MHz Offset Noise Floor Distribution, Output Frequency = 860 MHz, $P_{OUT} = -5$ dBm, 64 QAM Carrier, Symbol Rate = 5 MSPS

06118-022

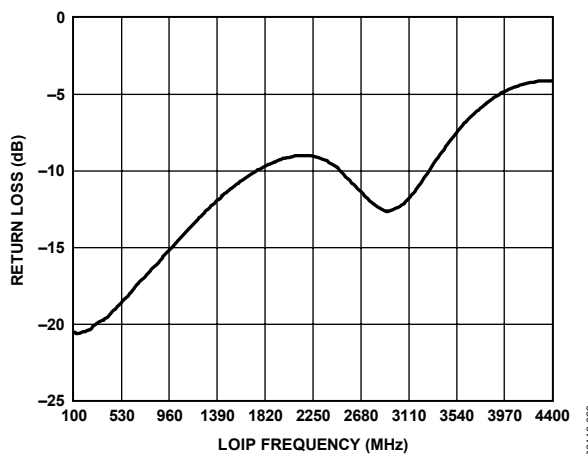

Figure 23. LO Port Input Return Loss vs. Frequency

06118-023

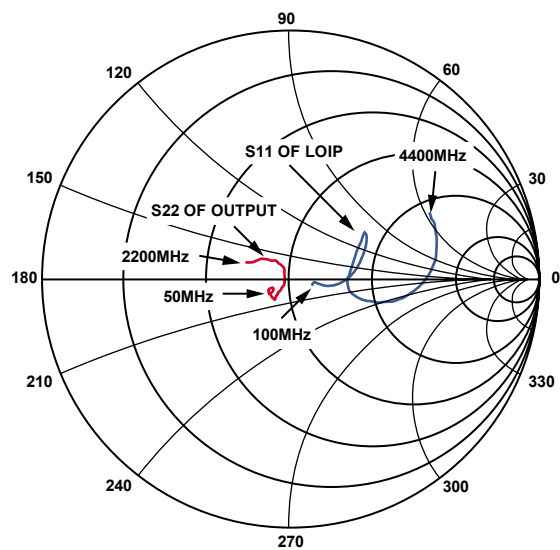

Figure 24. Output Impedance and LO Input Impedance vs. Frequency

06118-024

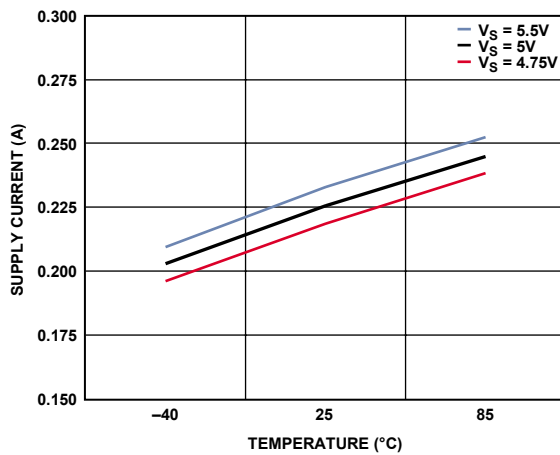

Figure 25. Power Supply Current vs. Temperature and Supply Voltage

06118-025



ADL5385

CIRCUIT DESCRIPTION

OVERVIEW

The ADL5385 can be divided into five sections: the local oscillator (LO) interface, the baseband voltage-to-current (V-to-I) converter, the mixers, the differential-to-single-ended (D-to-S) amplifier, and the bias circuit. A detailed block diagram of the device is shown in Figure 26.

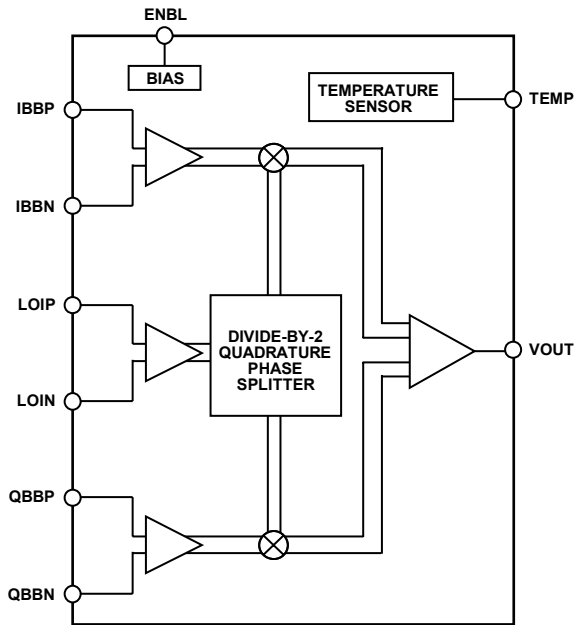

Figure 26. ADL5385 Block Diagram

The LO interface generates two LO signals at 90° of phase difference to drive two mixers in quadrature. Baseband signals are converted into currents by the V-to-I converters that feed into the two mixers. The outputs of the mixers are combined in the differential-to-single-ended amplifier, which provides a 50 Ω output interface. Reference currents to each section are generated by the bias circuit. A detailed description of each section follows.

LO INTERFACE

The LO interface consists of a buffer amplifier followed by a pair of frequency dividers that generate two carriers at half the input frequency and in quadrature with each other. Each carrier is then amplified and amplitude-limited to drive the double-balanced mixers.

V-TO-I CONVERTER

The differential baseband input voltages that are applied to the baseband input pins are fed to a pair of common-emitter, voltage-to-current converters. The output currents then modulate the two half-frequency LO carriers in the mixer stage.

MIXERS

The ADL5385 has two double-balanced mixers: one for the in-phase channel (I channel) and one for the quadrature channel (Q channel). These mixers are based on the Gilbert cell design of four cross-connected transistors. The output currents from the two mixers are summed together in the resistor-inductor (RL) loads in the D-to-S amplifier.

D-TO-S AMPLIFIER

The output D-to-S amplifier consists of two emitter followers driving a totem-pole output stage. Output impedance is established by the emitter resistors in the output transistors. The output of this stage connects to the output (VOUT) pin.

BIAS CIRCUIT

A band gap reference circuit generates the proportional-to-absolute-temperature (PTAT) as well as temperature-independent reference currents used by different sections. The band-gap circuit is turned on by a logic HIGH at the ENBL pin, which in turn powers up the whole device. A PTAT voltage output is available at the TEMP pin, which can be used for temperature monitoring as well as for temperature compensation purposes.



ADL5385

When an offset of $+V_{IOS}$ is applied to the I-channel inputs,

$$V_{IOPP} = 500 \text{ mV} + V_{IOS}/2, \text{ while}$$

$$V_{IOPN} = 500 \text{ mV} - V_{IOS}/2, \text{ such that}$$

$$V_{IOPP} - V_{IOPN} = V_{IOS}$$

The same applies to the Q channel.

It is often desirable to perform a one-time carrier null calibration. This is usually performed at a single frequency. Figure 29 shows how carrier feedthrough varies with LO frequency over a range of ± 50 MHz on either side of a null at 350 MHz.

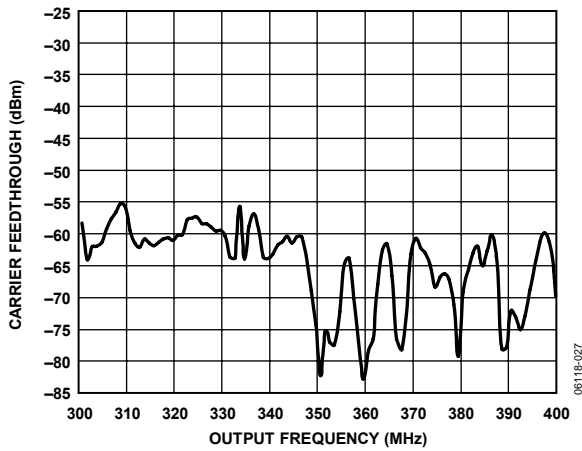

Figure 29. Carrier Feedthrough vs. Frequency After Nulling at 350 MHz

Sideband Suppression Optimization

Sideband suppression results from relative gain and relative phase offsets between the I and Q channels and can be suppressed through adjustments to those two parameters.

Figure 30 illustrates how sideband suppression is affected by the gain and phase imbalances.

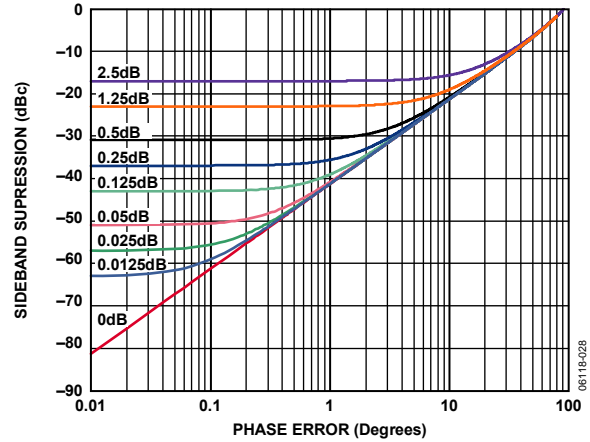

Figure 30. Sideband Suppression vs. Quadrature Phase Error for Various Quadrature Amplitude Offsets

Figure 30 underscores the fact that adjusting one parameter improves the sideband suppression only to a point; the other parameter must also be adjusted. For example, if the amplitude offset is 0.25 dB, improving the phase imbalance better than 1° does not yield any improvement in the sideband suppression. For optimum sideband suppression, an iterative adjustment between phase and amplitude is required.

The sideband suppression nulling can be performed either through adjusting the gain for each channel or through the modification of the phase and gain of the digital data coming from the digital signal processor.



APPLICATIONS

DAC MODULATOR INTERFACING

The ADL5385 is designed to interface with minimal components to members of the Analog Devices family of digital-to-analog converters (DAC). These DACs feature an output current swing from 0 to 20 mA, and the interface described in this section can be used with any DAC that has a similar output.

Driving the ADL5385 with an Analog Devices TxDAC®

An example of the interface using the AD9777 TxDAC is shown in Figure 31. The baseband inputs of the ADL5385 require a dc bias of 500 mV. The average output current on each of the outputs of the AD9777 is 10 mA. Therefore, a single 50 Ω resistor to ground from each of the DAC outputs results in an average current of 10 mA flowing through each of the resistors, thus producing the desired 500 mV dc bias for the inputs to the ADL5385.

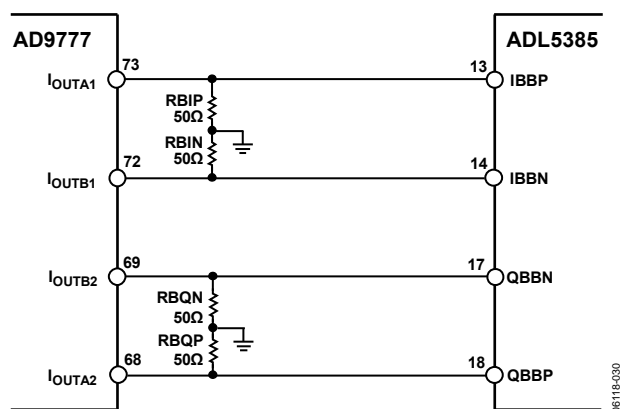

Figure 31. Interface Between AD9777 and ADL5385 with 50 Ω Resistors to Ground to Establish the 500 mV DC Bias for the ADL5385 Baseband Inputs

The AD9777 output currents have a swing that ranges from 0 to 20 mA. With the 50 Ω resistors in place, the ac voltage swing going into the ADL5385 baseband inputs ranges from 0 V to 1 V. A full-scale sine wave out of the AD9777 can be described as a 1 V p-p single-ended (or 2 V p-p differential) sine wave with a 500 mV dc bias.

Limiting the AC Swing

There are situations in which it is desirable to reduce the ac voltage swing for a given DAC output current. This can be achieved through the addition of another resistor to the interface. This resistor is placed in shunt between each side of the differential pair, as illustrated in Figure 32. It has the effect of reducing the ac swing without changing the dc bias already established by the 50 Ω resistors.

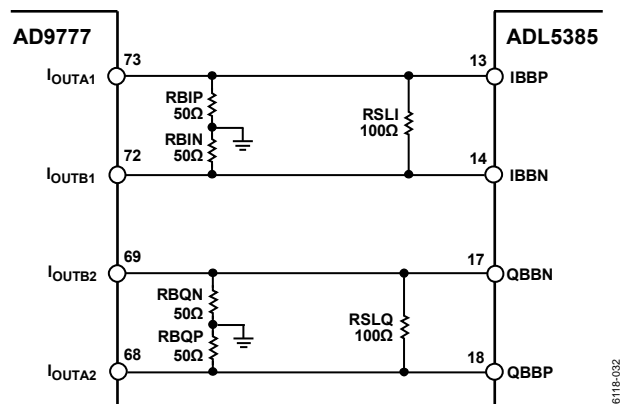

Figure 32. AC Voltage Swing Reduction Through Introduction of Shunt Resistor Between Differential Pair

The value of this ac voltage swing-limiting resistor is chosen based on the desired ac voltage swing. Figure 33 shows the relationship between the swing-limiting resistor and the peak-to-peak ac swing that it produces when 50 Ω bias-setting resistors are used.

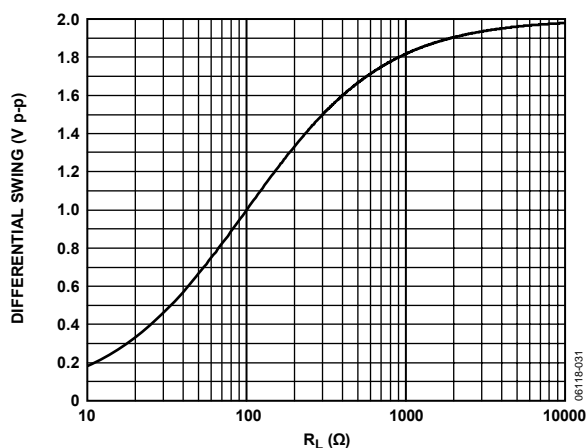

Figure 33. Relationship Between AC Swing-Limiting Resistor and Peak-to-Peak Voltage Swing with 50 Ω Bias-Setting Resistors

Filtering

When driving a modulator from a DAC, it is necessary to introduce a low-pass filter between the DAC and the modulator to reduce the DAC images. The interface for setting up the biasing and ac swing lends itself well to the introduction of such a filter. The filter can be inserted in between the dc bias setting resistors and the ac swing-limiting resistor, thus establishing the input and output impedances for the filter.

Examples of filters are discussed in the 155 MBPS (STM-1) 128 QAM Transmitter and the CMTS Transmitter Application sections.



ADL5385

Using AD9777 Auxiliary DAC for Carrier Feedthrough Nulling

The AD9777 features an auxiliary DAC that can be used to inject small currents into the differential outputs for each channel. The auxiliary DAC can produce the small offset currents necessary to implement the nulling described in the Carrier Feedthrough Nulling section.

155 Mbps (STM-1) 128 QAM TRANSMITTER

Figure 34 shows how the ADL5385 can be interfaced to the AD9777 DAC (or any Analog Devices dual DAC with an output bias level of 0.5 V) to generate a 155 Mbps 128 QAM carrier at 355 MHz. Because the TxDAC output and the IQ modulator inputs operate at the same bias levels of 0.5 V, a simple dc-coupled connection can be implemented without any active or passive level shifting. The bias level and modulator drive level is set by the 50 Ω ground-referenced resistors and the 100 Ω shunt resistors, respectively (see the DAC Modulator Interfacing section). A baseband filter is placed between the bias and signal swing resistors. This 5-pole Chebychev filter with in-band ripple of 0.1 dB has a corner frequency of 39 MHz.

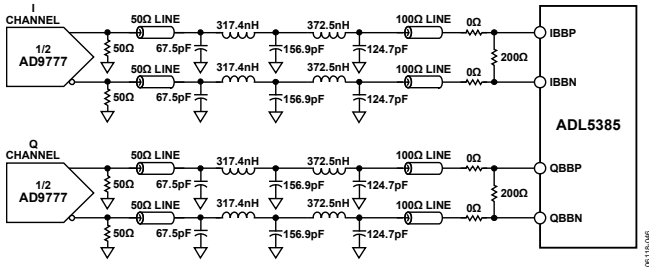

Figure 34. Recommended DAC-Modulator Interconnect for 128 QAM Transmitter

Figure 35 shows a spectral plot of the 128 QAM spectrum at a carrier power of -6.3 dBm. Figure 36 shows how EVM (measured with the analyzer's internal equalizer both on and off) and SNR, measured at 55 MHz carrier offset (2.5 times the carrier bandwidth) varies with output power.

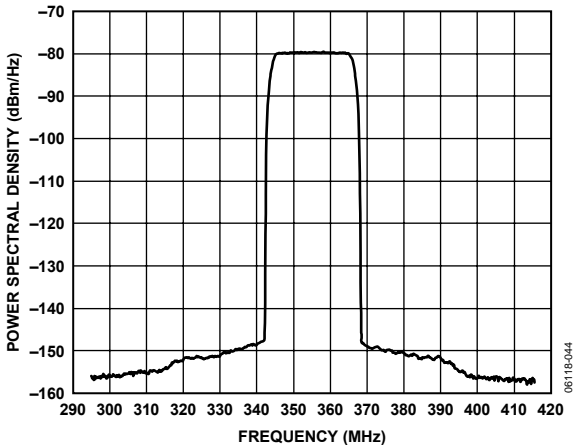

Figure 35. Spectral Plot of 128 QAM Transmitter at -6.3 dBm Output Power

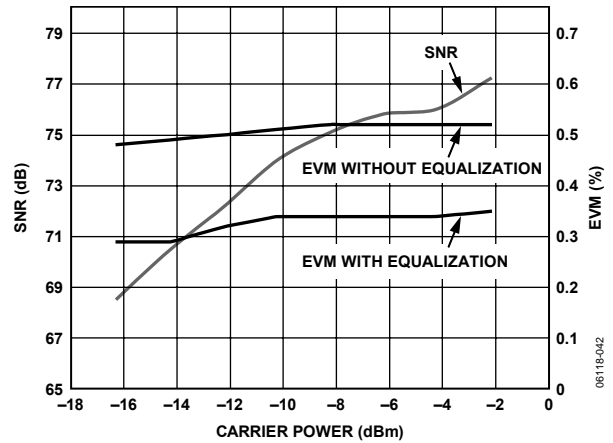

Figure 36. EVM and SNR vs. Output Power for 128 QAM Transmitter Application

CMTS TRANSMITTER APPLICATION

Because of its broadband operating range from 50 MHz to 2200 MHz, the ADL5385 can be used in direct-launch cable modem termination systems (CMTS) applications in the 50 MHz to 860 MHz cable band.

The same DAC and DAC-to-modulator interface and filtering circuit shown in Figure 34 was used in this application. Figure 37 shows a plot of a 4-carrier 256 QAM spectrum at an output frequency of 485 MHz. Figure 38 shows how adjacent channel power (measured at 750 KHz, 5.25 MHz, and 12 MHz offset from the last carrier) and modulation error ratio (MER) vary with carrier power.

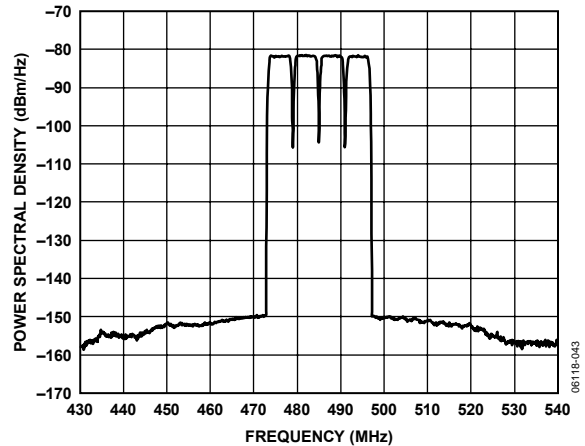

Figure 37. Spectrum of 4-Carrier 256 QAM CMTS Signal at 485 MHz



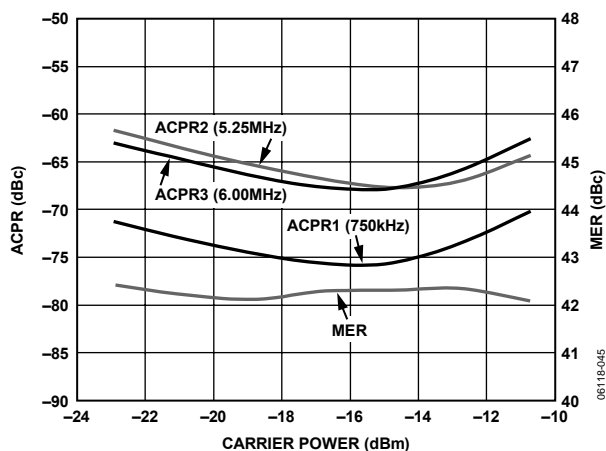

Figure 38. ACP1, ACP2, ACP3, and Modulation Error Ratio (MER) vs. Output Power for 256 QAM Transmitter

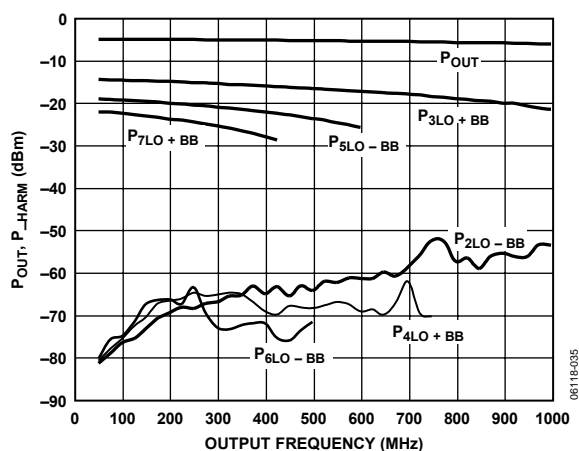

Figure 39. Spectral Components for Output Frequencies from 50 MHz to 1000 MHz

SPECTRAL PRODUCTS FROM HARMONIC MIXING

For broadband applications such as cable TV head-end modulators, special attention must be paid to harmonics of the LO. Figure 39 shows the level of these harmonics (out to 3 GHz) as a function of the output frequency from 50 MHz to 1000 MHz, in a single-sideband (SSB) test configuration, with a baseband signal of 1 MHz and a SSB level of approximately -5 dBm. To read this plot correctly, first pick the output frequency of interest on the trace called P_{OUT}. The associated harmonics can be read off the harmonic traces at multiples of this frequency. For example, at an output frequency of 500 MHz, the fundamental power is -5 dBm. The power of the second (P_{2fc - BB}) and third (P_{3fc + BB}) harmonics is -63 dBm (at 1000 MHz) and -16 dBm (at 1500 MHz), respectively. Of particular importance are the products from odd-harmonics of the LO, generated from the switching operation in the mixers.

For cable TV operation at frequencies above approximately 500 MHz, these harmonics fall out of the band and can be filtered by a fixed filter. However, as the frequency drops below 500 MHz, these harmonics start to fall close to or inside the cable band. This calls for either limitation of the frequency range to above 500 MHz or the use of a switchable filter bank to block in-band harmonics at low frequencies.

RF SECOND-ORDER PRODUCTS

A two-tone RF output signal produces second-order spectral components at sum and difference frequencies. In broadband systems, these intermodulation products fall inside the carrier or in the adjacent channels. Output second-order RF intermodulation intercept is defined as

$$OIP2_{RF} = P_{OUT} + (P_{OUT} - P_{IM(RF)})$$

where P_{IM(RF)} is the level of the intermodulation product at F_{OUT1} + F_{OUT2}. OIP2_{RF} levels from a two-tone test are plotted as a function of carrier frequency in Figure 40, where the baseband tones are 3.5 MHz and 4.5 MHz at -5 dBm each.

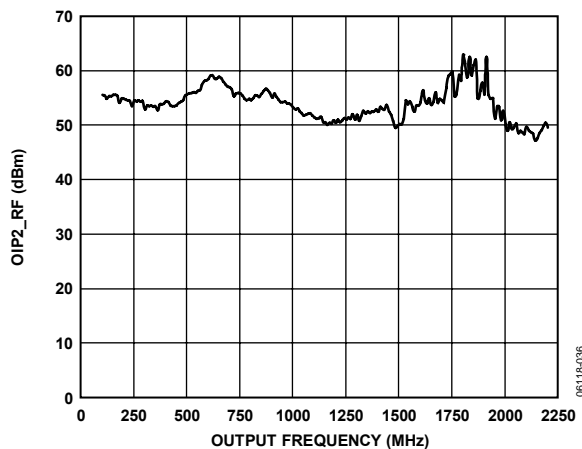

Figure 40. Output Second-Order Intermodulation vs. Carrier Frequency



ADL5385

LO GENERATION USING PLLs

Analog Devices has a line of PLLs that can be used for generating the LO signal. Table 4 lists the PLLs together with their maximum frequency and phase noise performance.

Table 4. PLL Selection Table

Model	Frequency F_{IN} (MHz)	@ 1 kHz Phase Noise dBc/Hz, 200 kHz PFD
ADF4110	550	-91 @ 540 MHz
ADF4111	1200	-87 @ 900 MHz
ADF4112	3000	-90 @ 900 MHz
ADF4113	4000	-91 @ 900 MHz
ADF4116	550	-89 @ 540 MHz
ADF4117	1200	-87 @ 900 MHz
ADF4118	3000	-90 @ 900 MHz

The ADF4360 comes as a family of chips, with nine operating frequency ranges. One can be chosen depending on the local oscillator frequency required. While the use of the integrated synthesizer might come at the expense of slightly degraded noise performance from the ADL5385, it can be a cheaper alternative to a separate PLL and VCO solution. Table 5 shows the options available.

Table 5. ADF4360 Family Operating Frequencies

Model	Output Frequency Range (MHz)
ADF4360-0	2400/2725
ADF4360-1	2050/2450
ADF4360-2	1850/2150
ADF4360-3	1600/1950
ADF4360-4	1450/1750
ADF4360-5	1200/1400
ADF4360-6	1050/1250
ADF4360-7	350/1800
ADF4360-8	65/400

TRANSMIT DAC OPTIONS

The AD9777 recommended in the previous sections is by no means the only DAC that can be used to drive the ADL5385. There are other appropriate DACs depending on the level of performance required. Table 6 lists the dual Tx-DACs that Analog Devices offers.

Table 6. Dual Tx—DAC Selection Table

Part	Resolution (Bits)	Update Rate (MSPS Minimum)
AD9709	8	125
AD9761	10	40
AD9763	10	125
AD9765	12	125
AD9767	14	125
AD9773	12	160
AD9775	14	160
AD9777	16	160
AD9776	12	1000
AD9778	14	1000
AD9779	16	1000

All DACs listed have nominal bias levels of 0.5 V and use the same DAC-modulator interface shown in Figure 31.

MODULATOR/DEMULATOR OPTIONS

Table 7 lists other Analog Devices modulators and demodulators.

Table 7. Modulator/Demodulator Options

Part	Mod/Demod	Frequency Range (MHz)	Comments
AD8345	Mod	140 to 1000	External Quadrature
AD8346	Mod	800 to 2500	
AD8349	Mod	700 to 2700	
ADL5390	Mod	20 to 2400	
ADL5370	Mod	300 to 1000	
ADL5371	Mod	700 to 1300	
ADL5372	Mod	1600 to 2400	
ADL5373	Mod	2300 to 3000	
ADL5374	Mod	3000 to 4000	
AD8347	Demod	800 to 2700	
AD8348	Demod	50 to 1000	
AD8340	Vector Mod	700 to 1000	
AD8341	Vector Mod	1500 to 2400	



EVALUATION BOARD

A populated, RoHS-compliant ADL5385 evaluation board is available. The ADL5385 has an exposed paddle underneath the package, which is soldered to the board. The evaluation board is designed without any components on the underside so that heat can be applied to the underside for easy removal and replacement of the ADL5385.

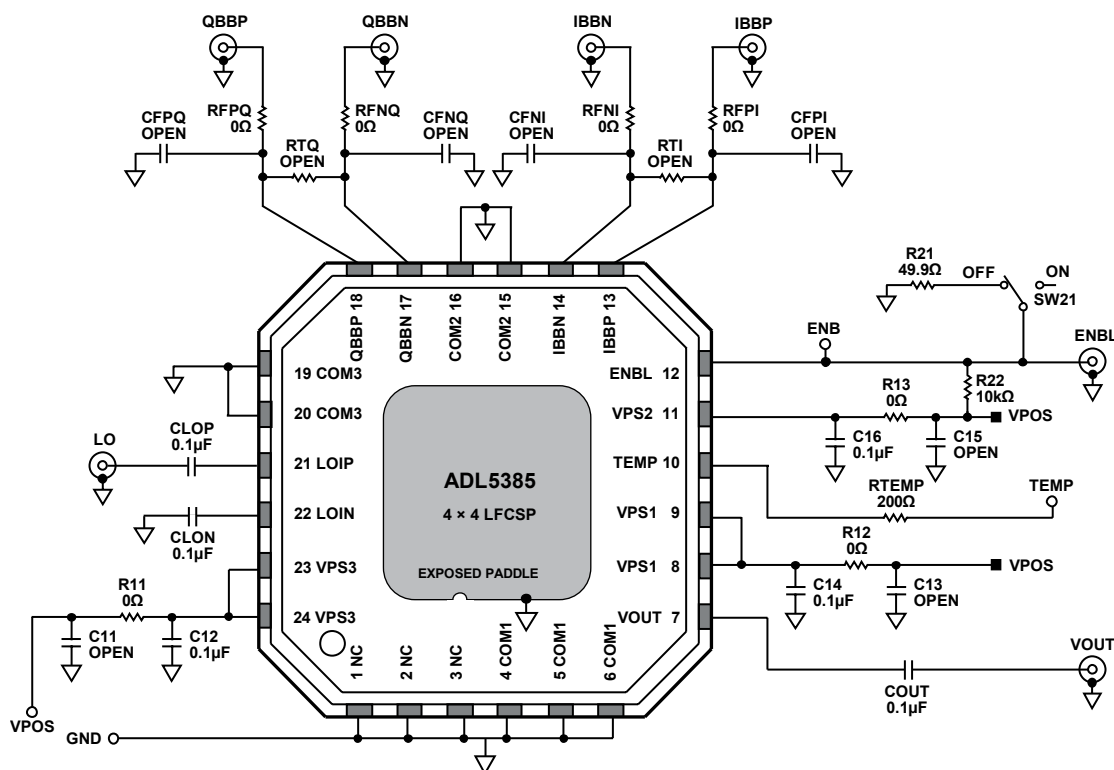

Figure 41. Evaluation Board Schematic

06118-0-41

Table 8. Evaluation Board Configuration Options

Component	Function	Default Condition
VPOS, GND	Power Supply and Ground Clip Leads.	Not applicable
SW21, R21, R22, ENB Test Point, ENBL SMA	Device Enable. Set SW21 to the OFF position to power down the device; set SW21 to the ON position to enable the device. Part can be driven from an external enable control source via the test point or the SMA connector. R21 provides a 50 Ω termination for any 50 Ω driving source.	R21 = 50 Ω, R22 = 10k Ω, SW21 = ON
RFNQ, CFNQ, RTQ, CFPQ, RFPQ, RFNI, CFNI, RTI, CFPI, RFPI	Baseband Input Filters. These components can be used to implement a low-pass filter for the baseband signals.	RFNQ, RFPQ, RFNI, RFPI = 0 Ω (0402) RTQ, RTI = open (0402) CFNQ, CFPQ, CFNI, CFPI = open (0402)



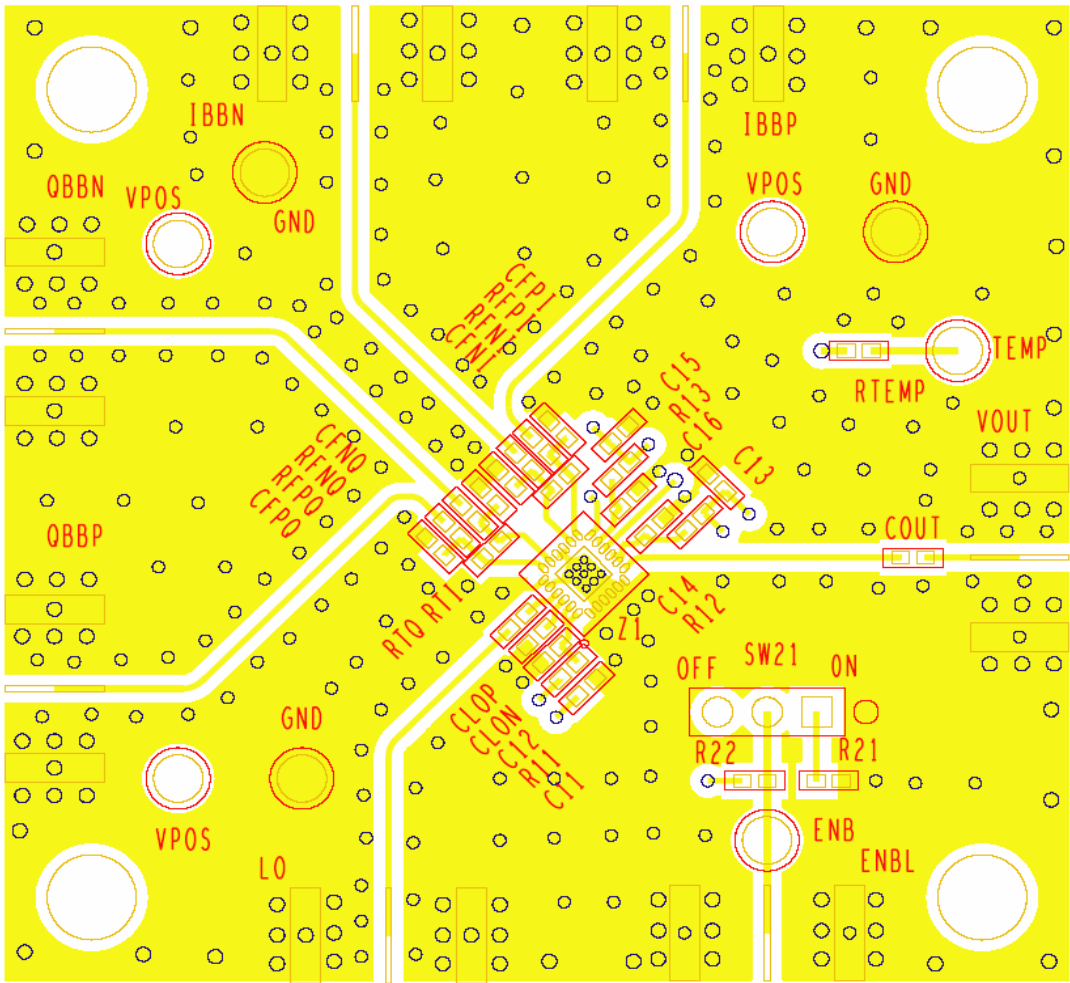

06118-039

Figure 42. Layout of Evaluation Board



CHARACTERIZATION SETUP

SSB SETUP

Figure 43 is a diagram of the characterization test stand setup for the ADL5385, which is intended to test the product as a single-sideband modulator. The Aeroflex IFR3416 signal generator provides the I and Q inputs as well as the LO input. Output signals are measured directly using the spectrum analyzer, and currents and voltages are measured using the Agilent 34401A multimeter.

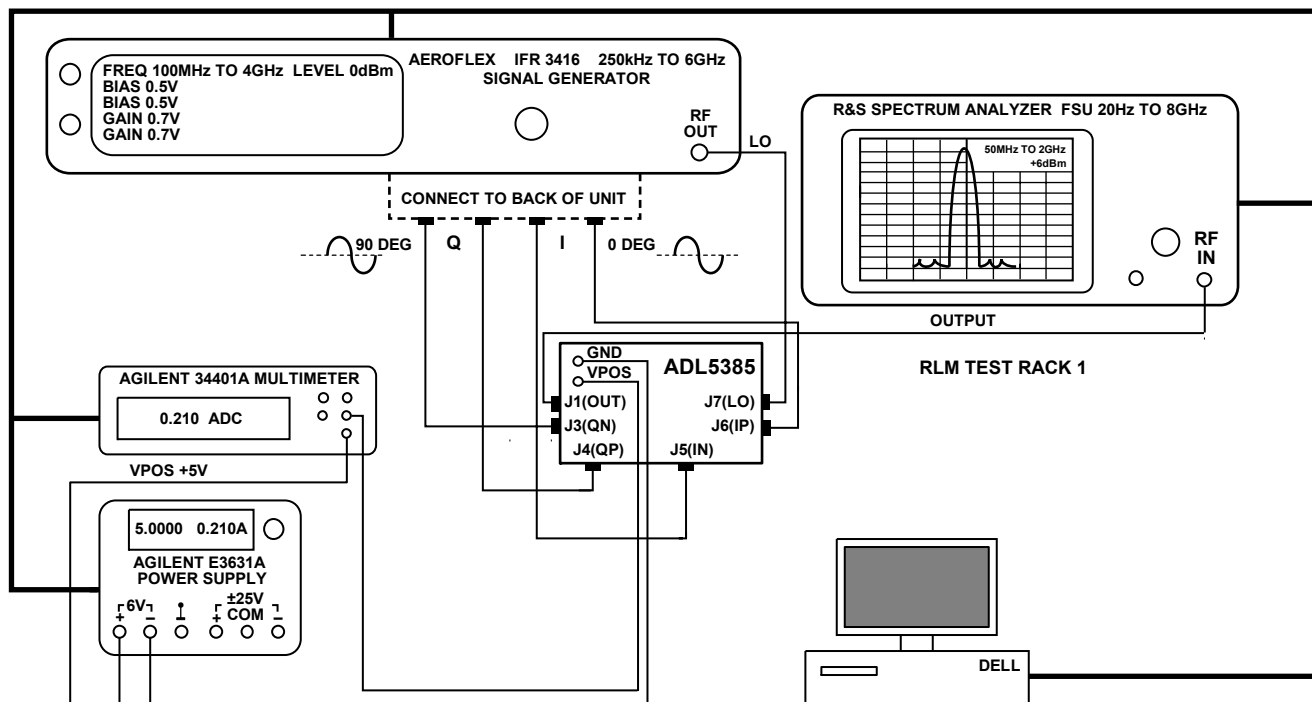

Figure 43. ADL5385 Characterization Board SSB Test Setup

06119-040



ADL5385

OUTLINE DIMENSIONS

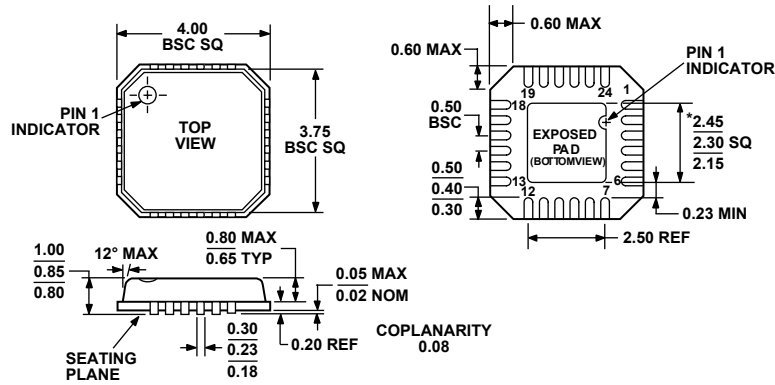

*COMPLIANT TO JEDEC STANDARDS MO-220-VGGD-2 EXCEPT FOR EXPOSED PAD DIMENSION

Figure 44. 24-Lead Lead Frame Chip Scale Package [LFCSP_VQ]
 4 mm × 4 mm Body, Very Thin Quad
 (CP-24-2)
 Dimensions shown in millimeters

ORDERING GUIDE

Model	Temperature Range	Package Description	Package Option	Ordering Quantity
ADL5385ACPZ-WP ¹	-40°C to +85°C	24-Lead LFCSP_VQ, Waffle Pack	CP-24-2	64
ADL5385ACPZ-R2 ¹	-40°C to +85°C	24-Lead LFCSP_VQ, 7" Tape and Reel	CP-24-2	250
ADL5385ACPZ-R7 ¹	-40°C to +85°C	24-Lead LFCSP_VQ, 7" Tape and Reel	CP-24-2	1500
ADL5385-EVALZ ¹		Evaluation Board		1

¹ Z = Pb-free part.



NOTES



ADL5385

NOTES

