

DESCRIPTION

The ULN2803/2804 series are high-voltage, high-current darlington arrays comprised of eight NPN darlington pairs. All units feature integral clamp diodes for switching inductive loads.

FEATURES

- Output current.....500mA
- High Sustaining Voltage.....50V Min.
- Output Clamp Diode
- Inputs Compatible With Various Types of Logic

Type	Input Resistor	Designation
ULN2803	2.7K Ω	TTL, 5V C-MOS
ULN2804	10.5K Ω	6~15V P-MOS, C-MOS

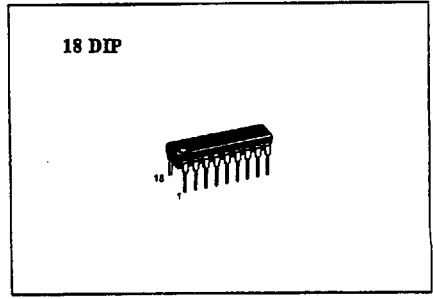

MAXIMUM RATING(Ta=25°C unless otherwise)

Characteristic	Symbol	Rating	Unit
Output Sustaining Voltage	$V_{CE(SUS)}$	50	V
Output Current	I_{OUT}	500	mA
Input Voltage	V_{IN*}	-0.5~+30	V
Input Current	I_{IN*}	25	mA
Clamp Diode	Reverse Voltage	V_R	50
	Forward Current	I_F	500
GND Terminal Current	I_{GND}	3.2	A
Power Dissipation	P_D	1.47	W
Operating Temperature	T_{opr}	-40~85	°C
Storage Temperature	T_{stg}	-55~150	°C

PIN CONNECTION (TOP VIEW)

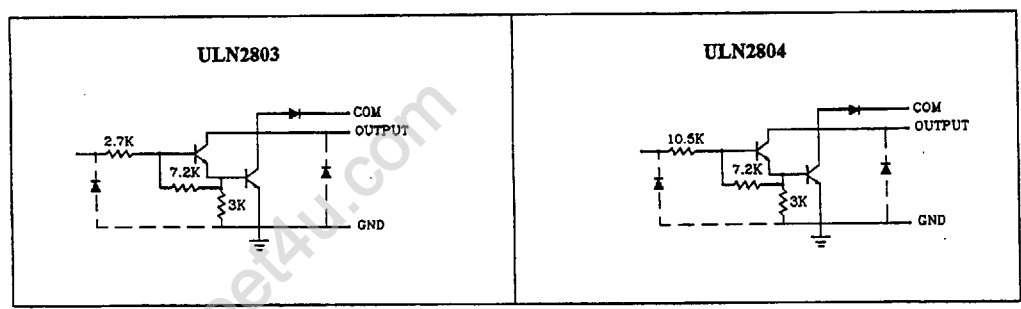
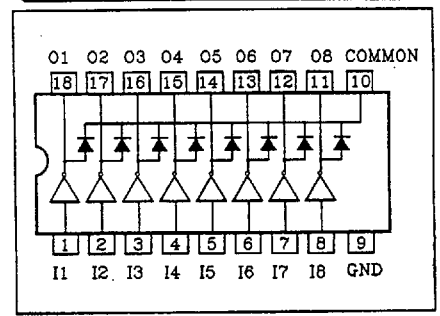

RECOMMENDED OPERATING CONDITIONS(Ta=-40-85°C)

CHARACTERISTIC	SYMBOL	CONDITION	MIN.	TYP.	MAX.	UNIT
Output Sustaining Voltage	$V_{CE(SUS)}$		0	-	50	V
Output Current	I_{OUT}	$T_{FW}=25mS, DF=8\%, 8$ Circuits	0	-	400	mA
		$T_{FW}=25mS, DF=25\%$ 8 Circuits	0	-	200	mA
Input Voltage	V_{IN}		0	-	30	V
Clamp Diode Reverse Voltage	V_R		-	-	50	V
Clamp Diode Forward Current	I_F		-	-	400	mA
Power Dissipation	P_D		-	-	0.52	W

ELECTRICAL CHARACTERISTICS(Ta=25°C unless otherwise noted)

CHARACTERISTIC	SYMBOL	TEST CIRCUIT	CONDITION	MIN.	TYP.	MAX.	UNIT
Output leak Current	I_{CEX}	1	$V_{CE}=50V, T_a=25^\circ C$	-	-	50	μA
			$V_{CE}=50V, T_a=85^\circ C$	-	-	100	
			$V_{CE}=50V, V_{IN}=-1V$	-	-	500	
Collector-Emitter Saturation Voltage	$V_{CE(sat)}$	2	$I_{OUT}=350mA, I_{IN}=500\mu A$	-	1.3	1.6	V
			$I_{OUT}=200mA, I_{IN}=350\mu A$	-	1.1	1.3	
			$I_{OUT}=100mA, I_{IN}=250\mu A$	-	0.9	1.1	
Input Current	ULN2803	$I_{IN(on)}$	$V_{IN}=3.85V$	-	0.93	1.35	mA
			$V_{IN}=5V$	-	0.35	0.5	
	ULN2804		$V_{IN}=12V$	-	1.0	1.45	
	$I_{ON(OFF)}$		4	$I_{OUT}=500\mu A, T_a=85^\circ C$	50	65	
Input Voltage	ULN2803	$V_{IN(ON)}$	$V_{CE}=2V, I_{OUT}=200mA$	-	-	2.4	V
			$V_{CE}=2V, I_{OUT}=250mA$	-	-	2.7	
			$V_{CE}=2V, I_{OUT}=300mA$	-	-	3.0	
	ULN2804		$V_{CE}=2V, I_{OUT}=125mA$	-	-	5.0	
	$V_{CE}=2V, I_{OUT}=200mA$		-	-	6.0		
	$V_{CE}=2V, I_{OUT}=275mA$		-	-	7.0		
	$V_{CE}=2V, I_{OUT}=350mA$		-	-	8.0		
DC Current Transistor Ratio	h_{FE}	2	$V_{CE}=2V, I_{OUT}=350mA$	1000	-	-	
Clamp Diode Reverse Current	I_E	6	$V_R=50V, T_a=25^\circ C$	-	-	50	μA
Clamp Diode Forward Voltage	V_F	7	$V_R=50V, T_a=85^\circ C$	-	-	100	V
			$I_F=350mA$	-	-	2.0	
Input Capacitance	C_{IN}			-	15	-	pF
Turn-On Delay	t_{ON}	8	$V_{OUT}=50V, R_L=163\Omega$	-	0.1	-	μS
Turn-Off Delay	t_{OFF}			$C_L=15 pF$	-	0.2	

TEST CIRCUIT

1. I_{CEX}

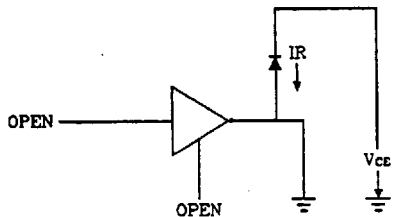

2. $V_{CE(sat)}$, h_{FE}

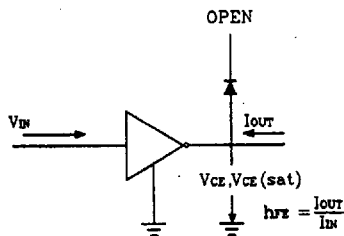

3. $I_{IN(ON)}$

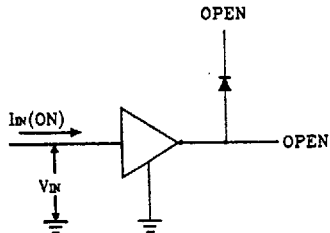

4. $I_{IN(OFF)}$

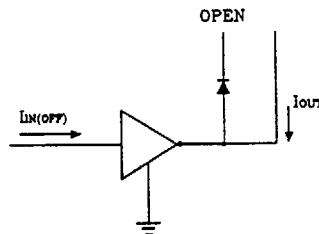

5. $V_{IN(ON)}$

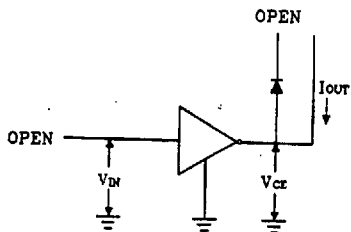

6. I_R

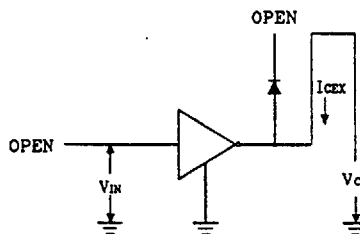

7. V_F

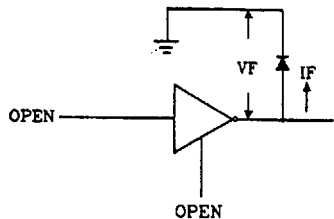

8. t_{ON} , t_{OFF}

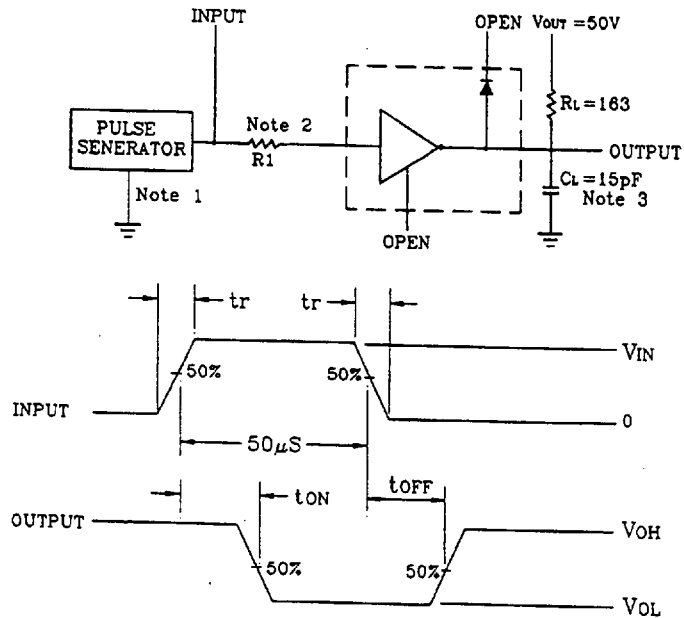

Notes: 1. Pulse Width $50\mu s$, Duty Cycle 10%

Output Impedance 50Ω

$t_r \leq 5ns$, $t_f \leq 10ns$

2. See below

Input Conditions

TYPE NUMBER	R_L	V_{IH}
ULN2803	0	3V
ULN2804	0	8V

3. C_L includes prob and jig capacitance.

ULN2803 $I_{IN} - V_{IN}$

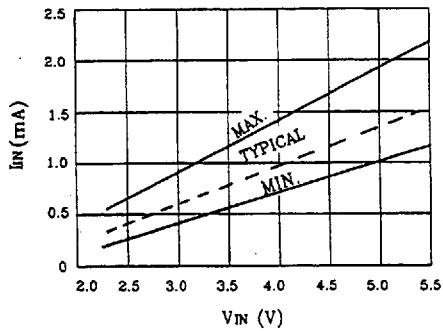

ULN2804 $I_{IN} - V_{IN}$

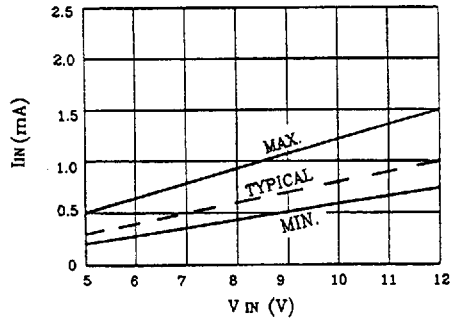

$F_D - T_a$

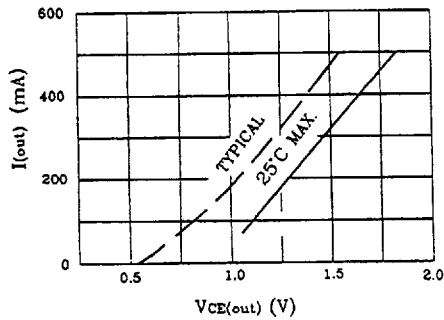

$I_{OUT} - V_{CE(out)}$

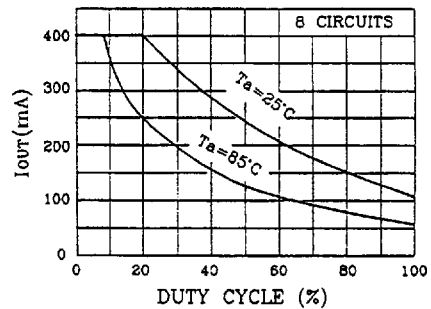

$I_{OUT} - DUTY CYCLE$

